

- EN** Artery Forceps
- DE** Arterienklemmen
- ES** Pinzas hemostáticas

Page 117 to 157

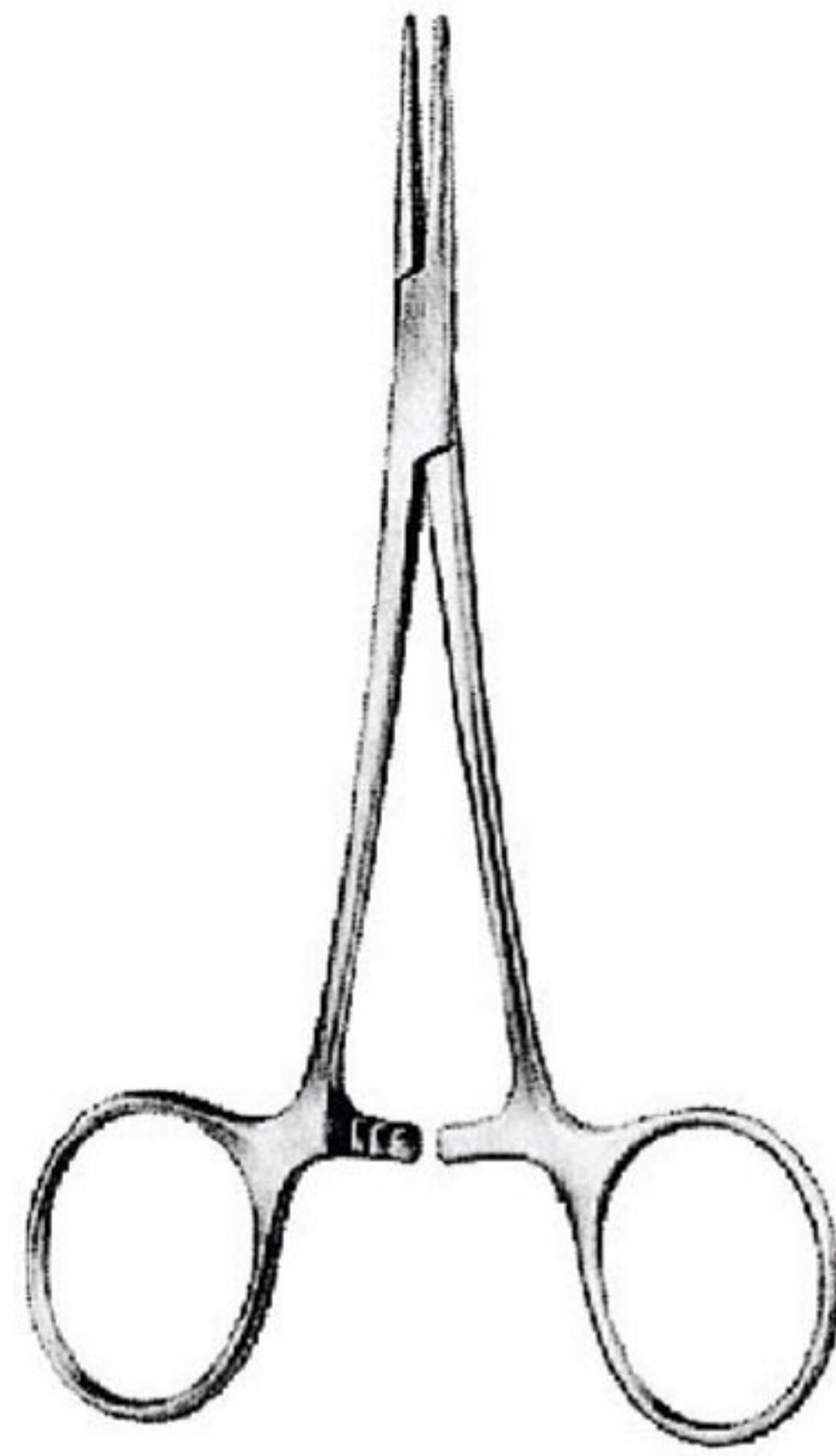



HALSTED-MOSQUITO

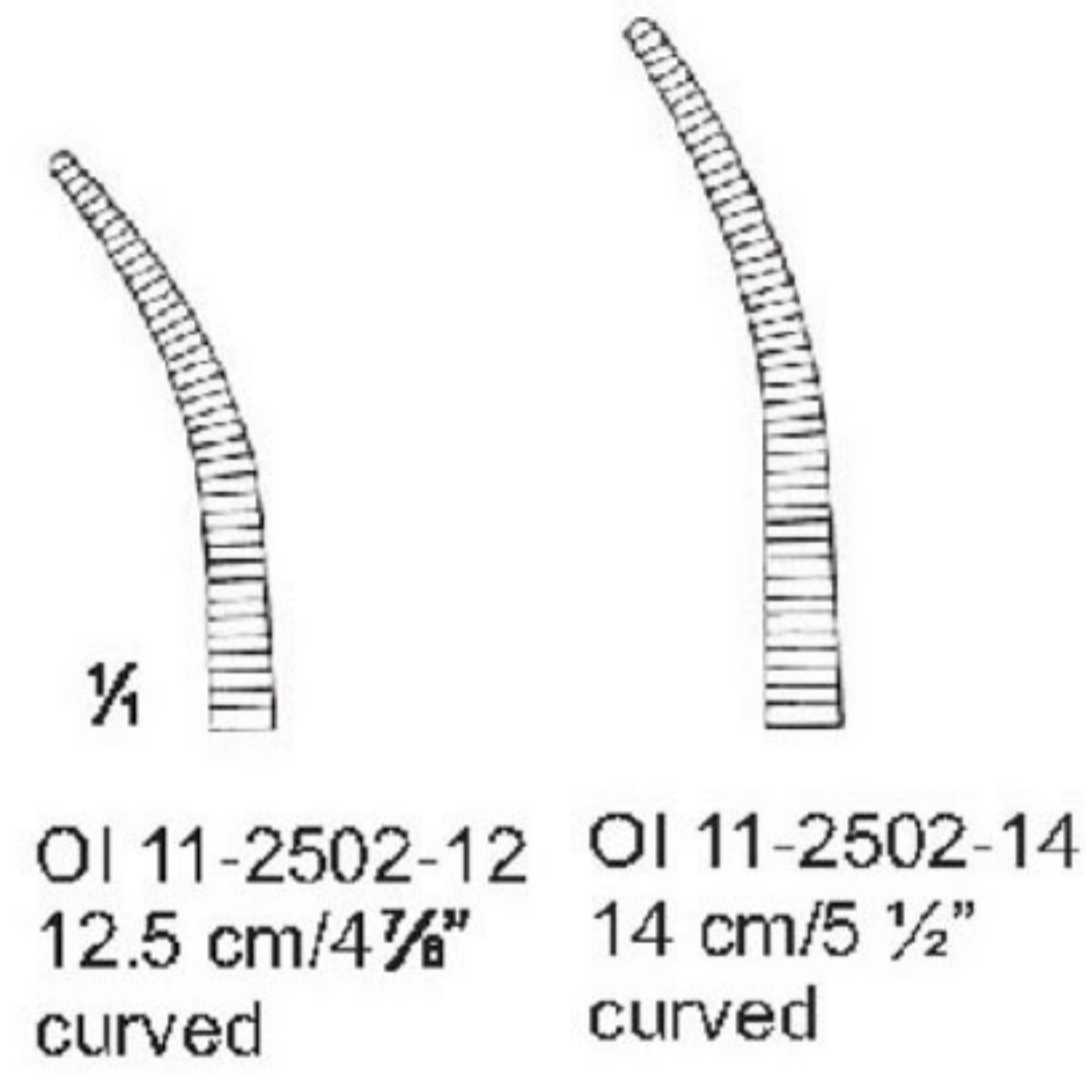
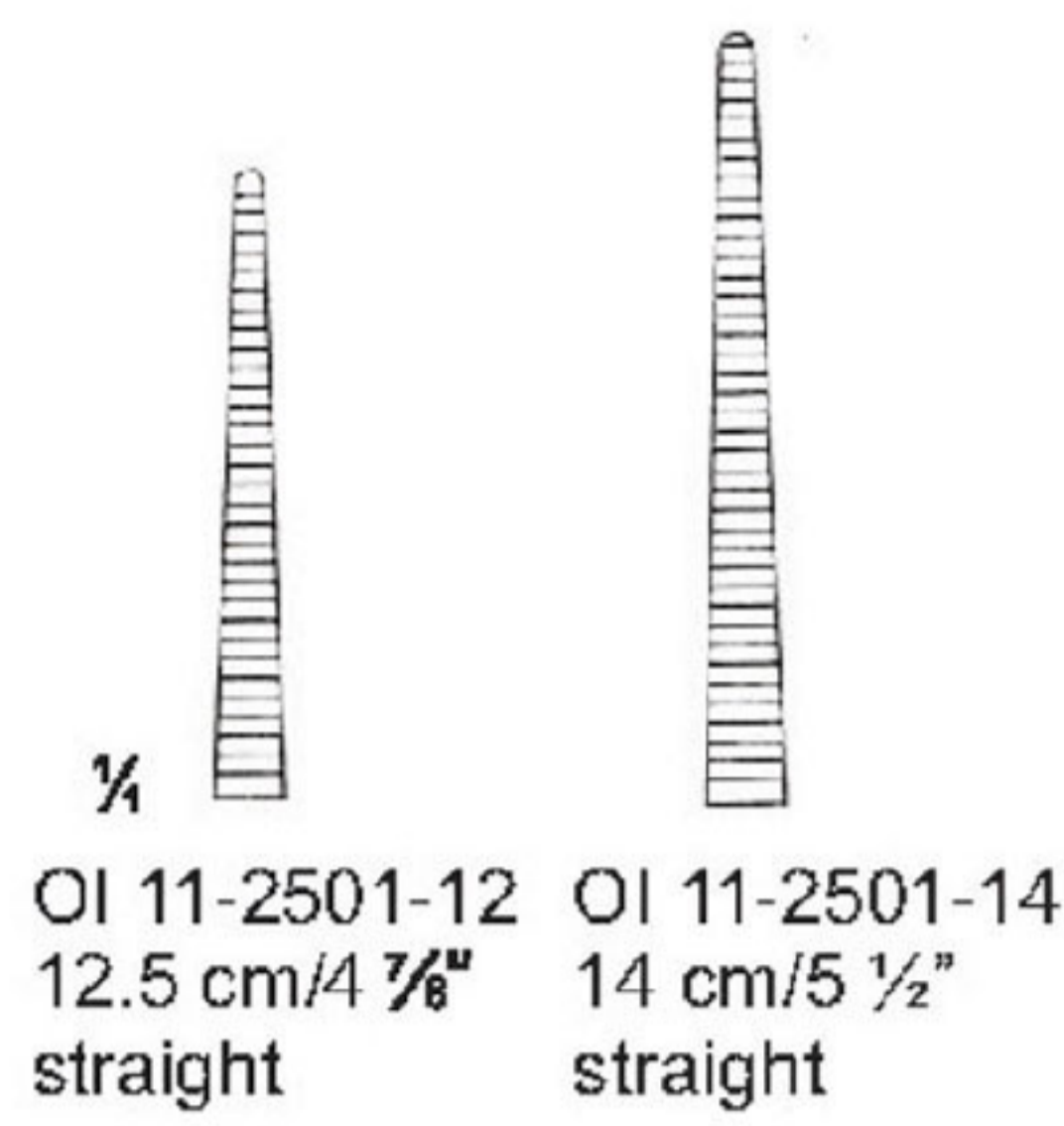

HALSTED-MOSQUITO

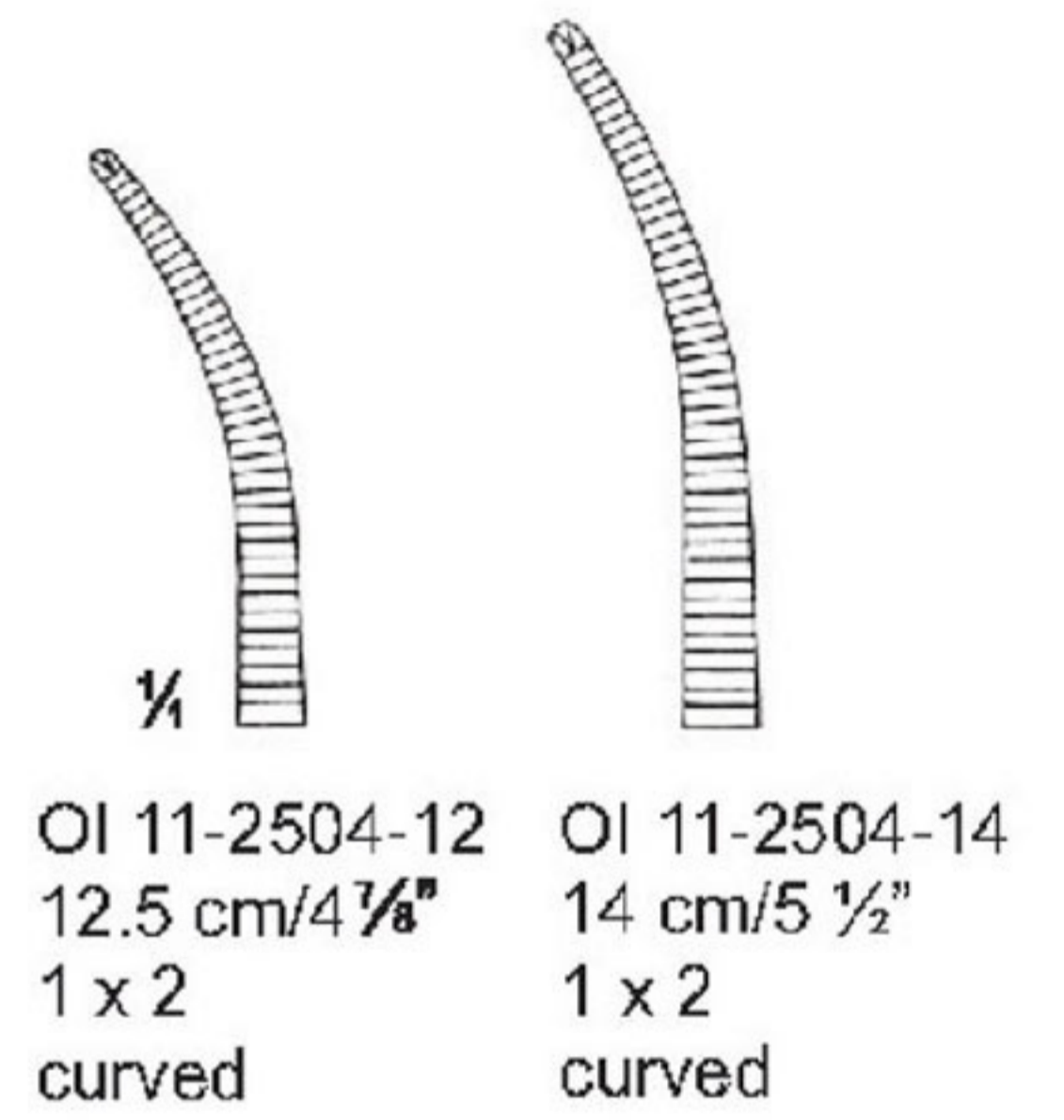
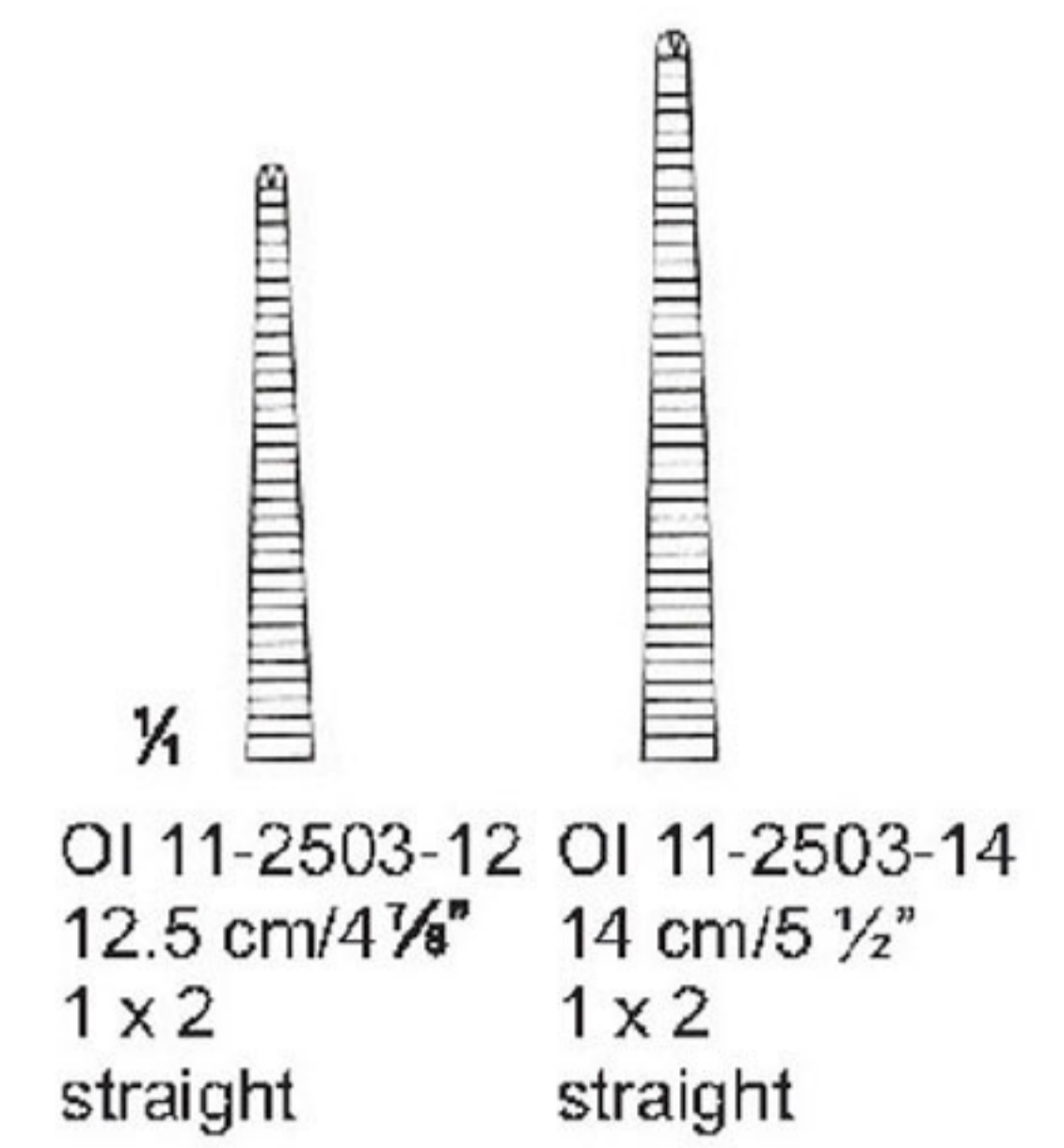

ATRAUMA

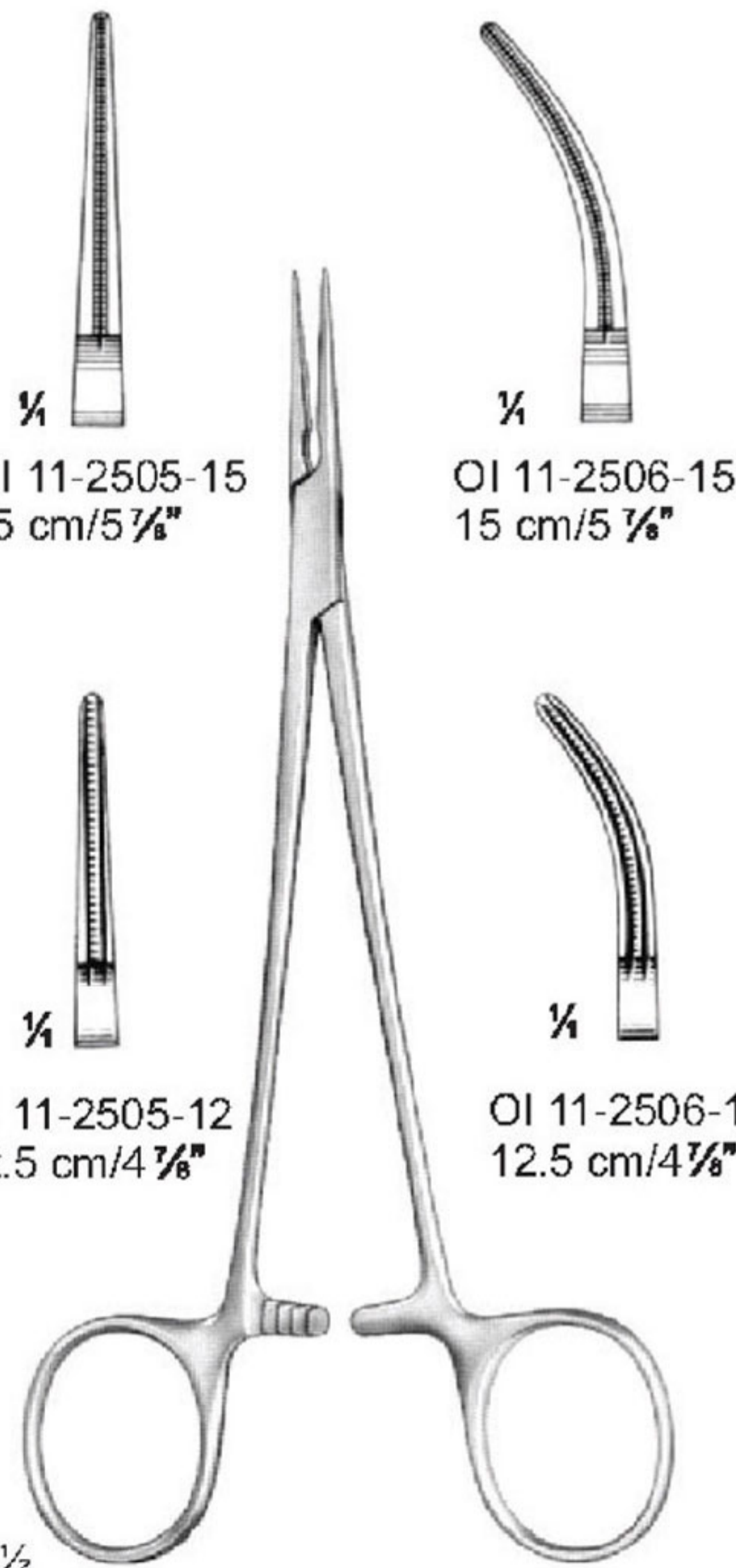

DEBAKEY-MOSQUITO

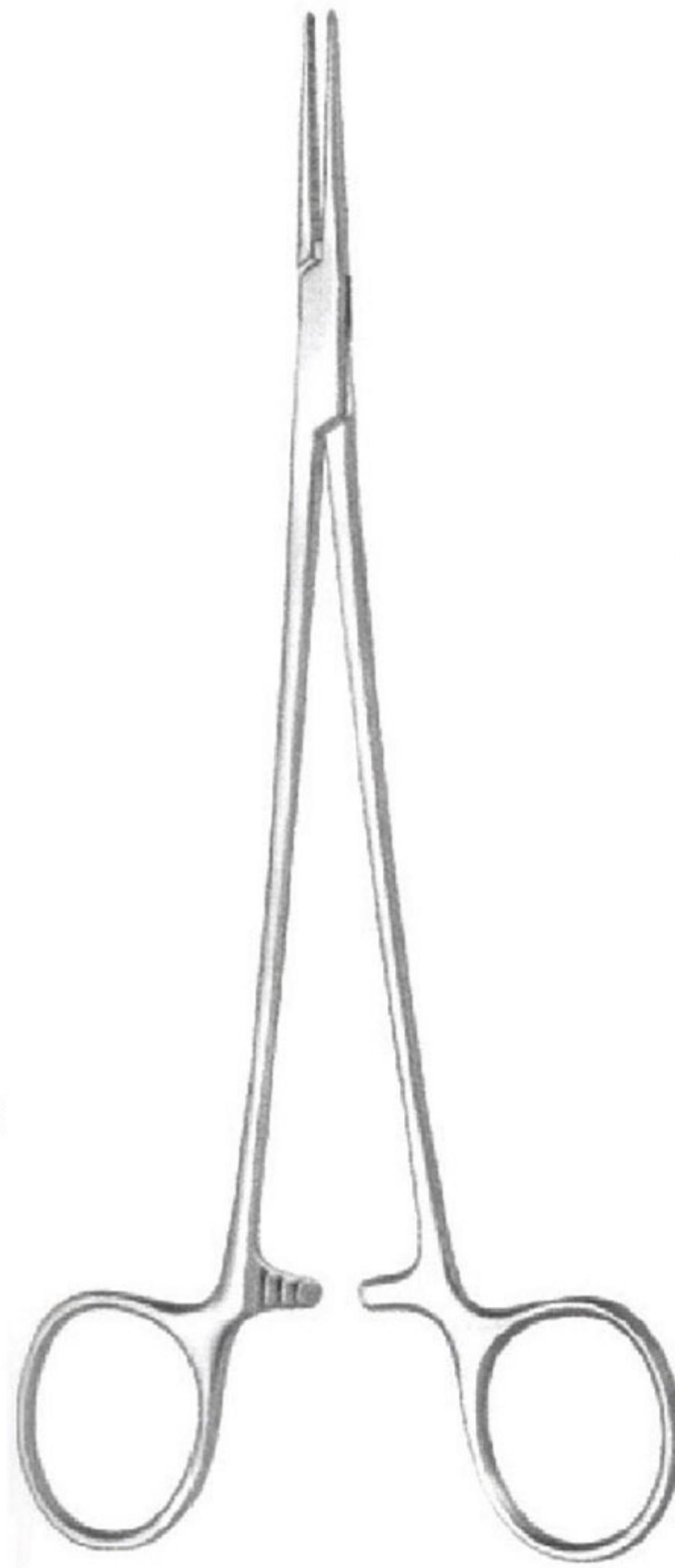
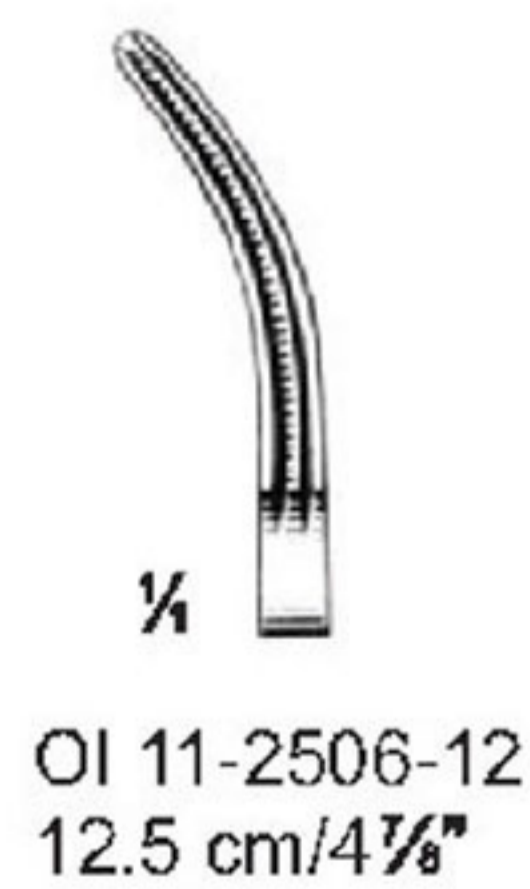
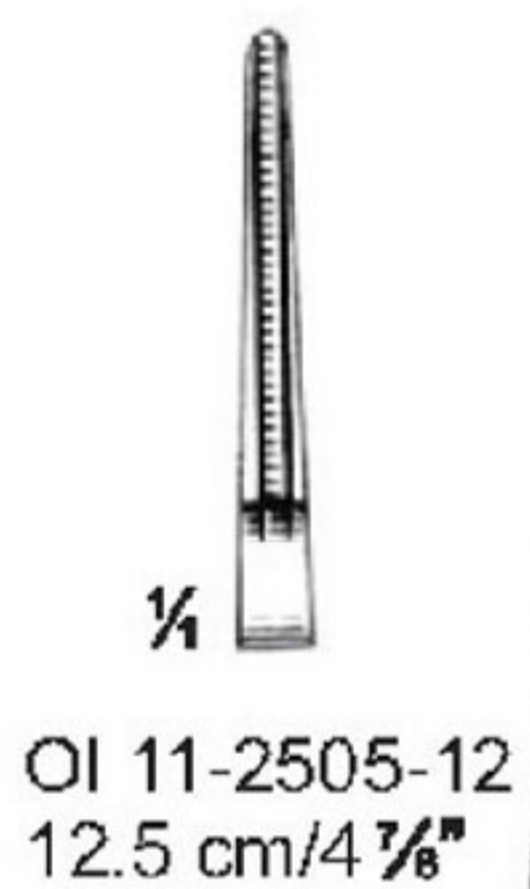
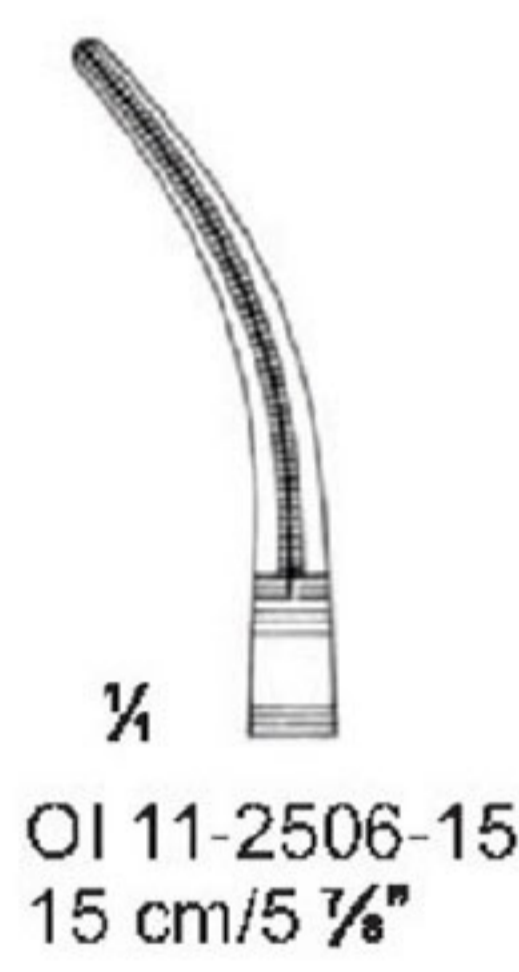
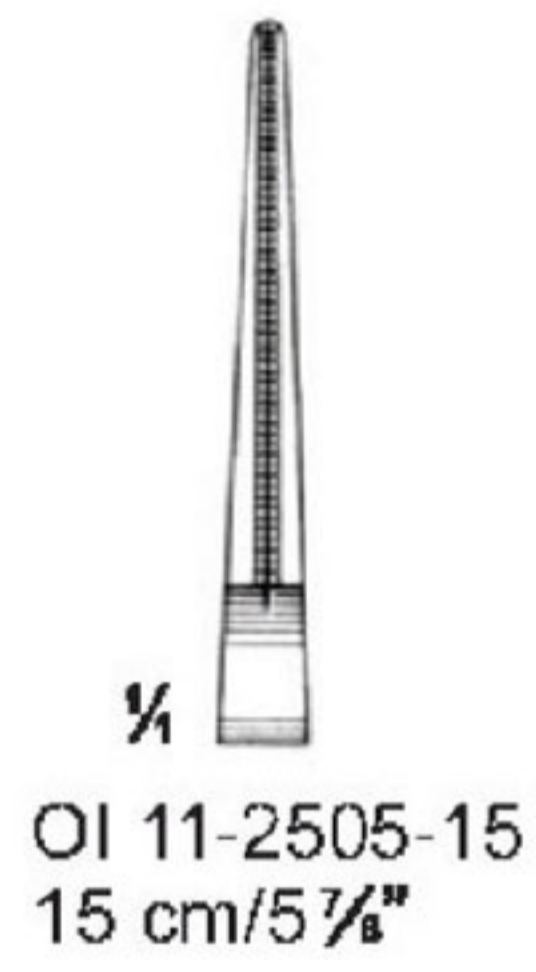

HALSTED-MOSQUITO

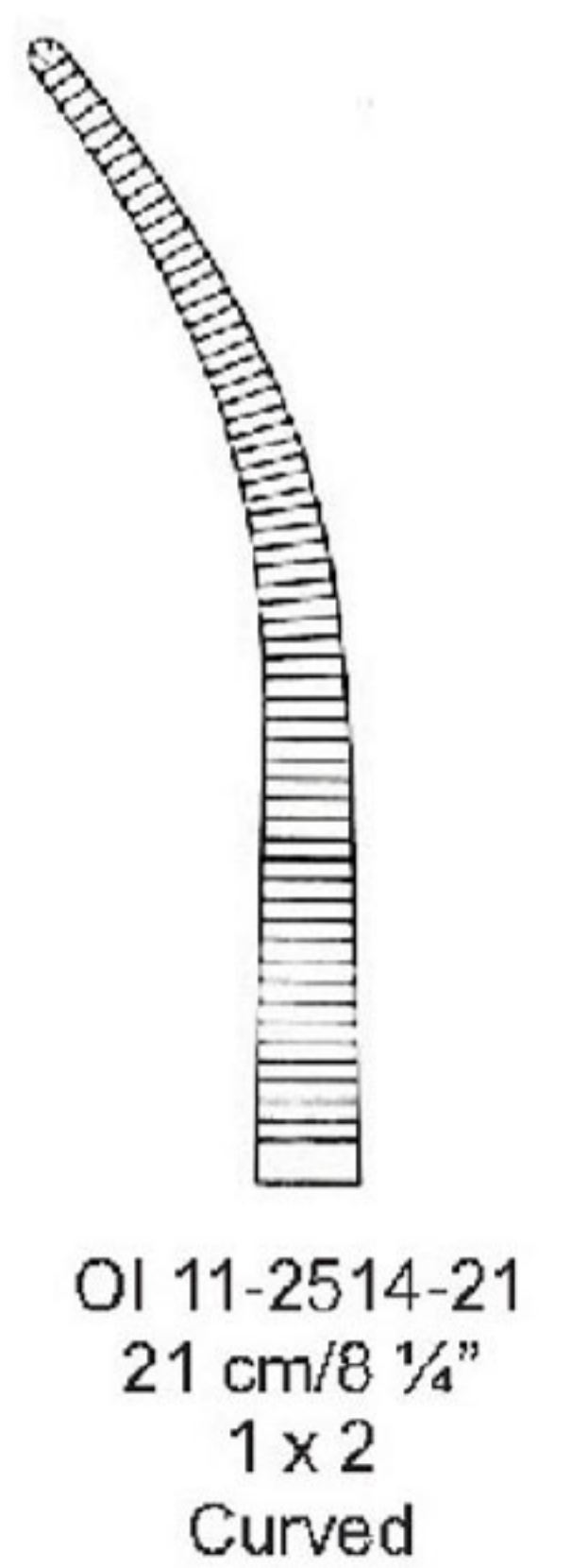
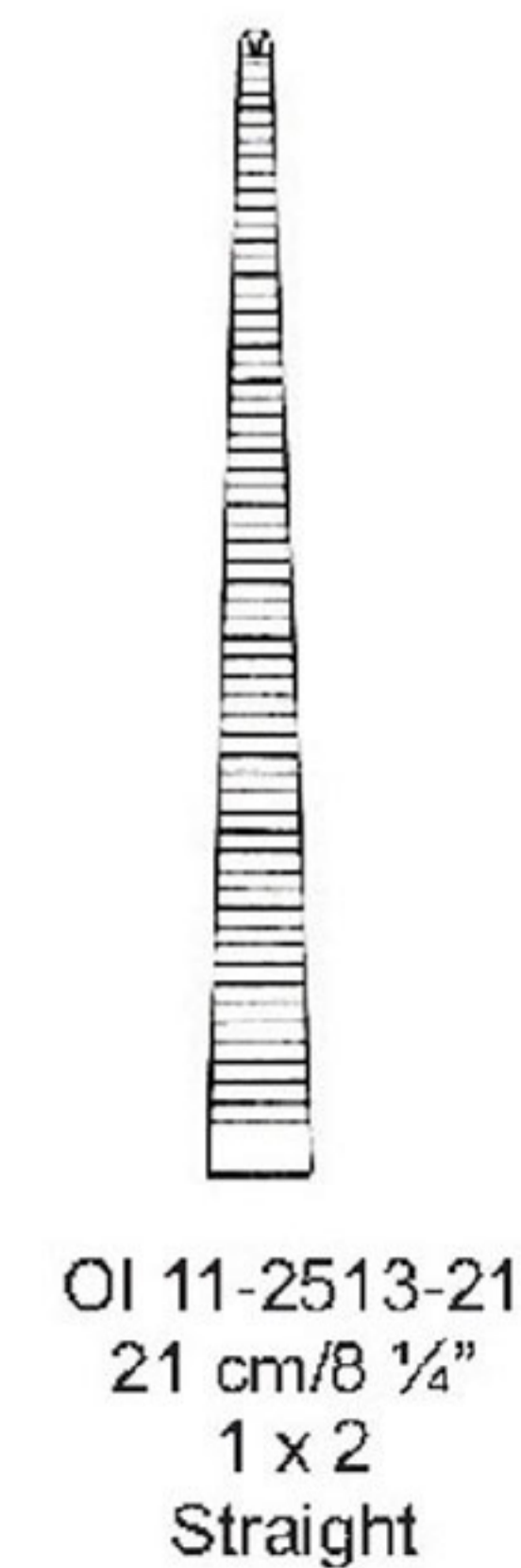
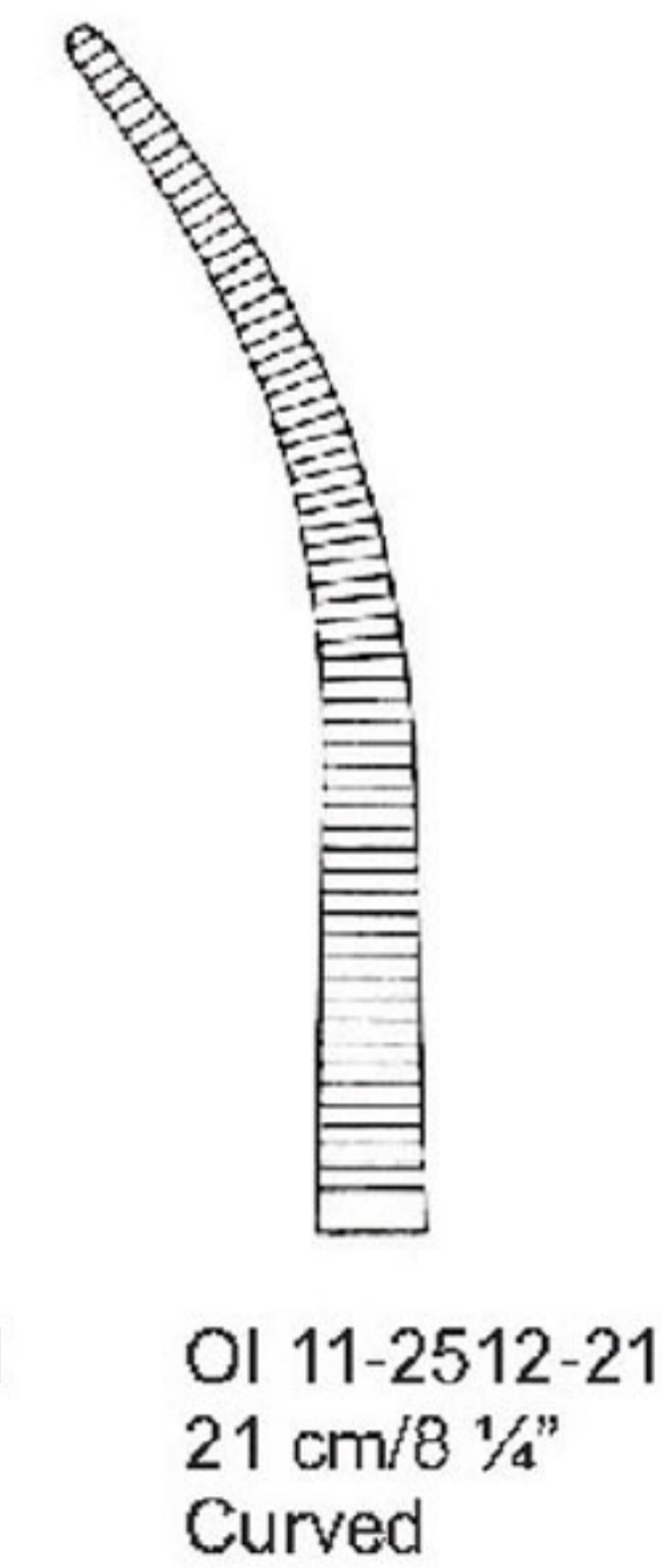
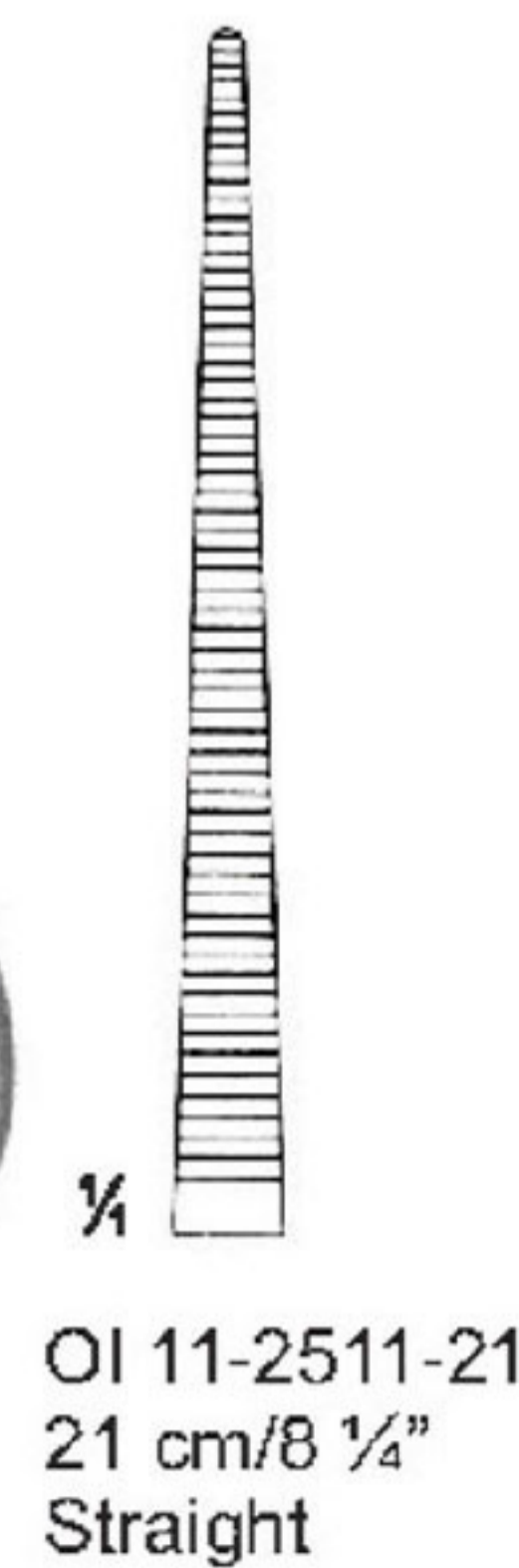
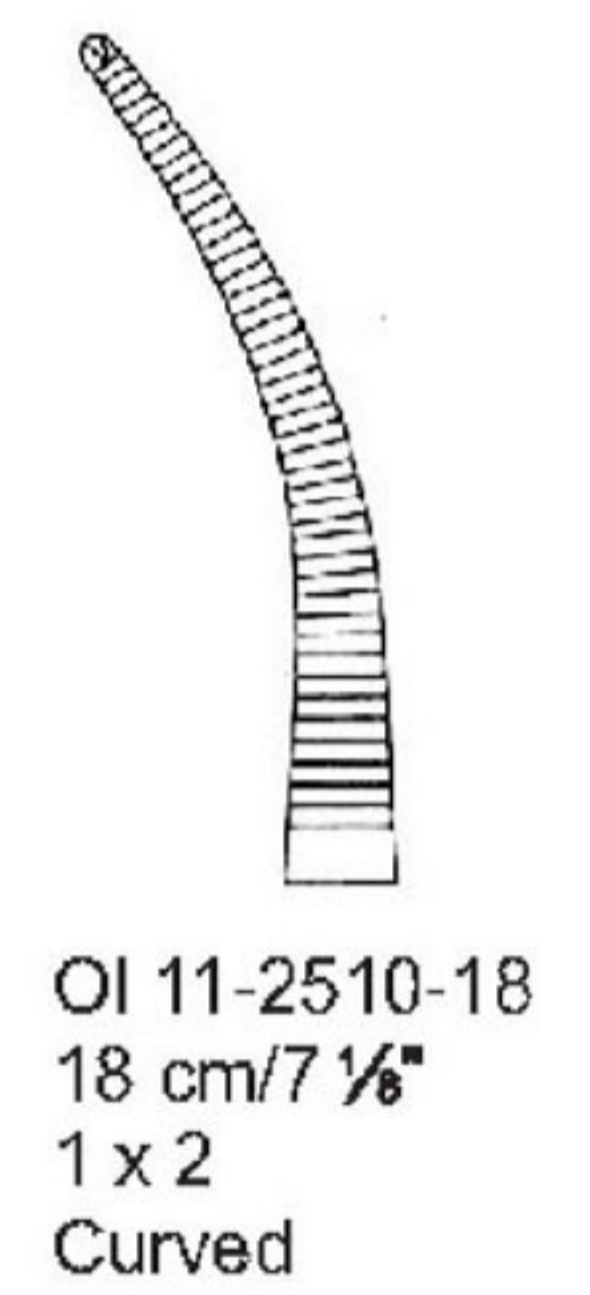
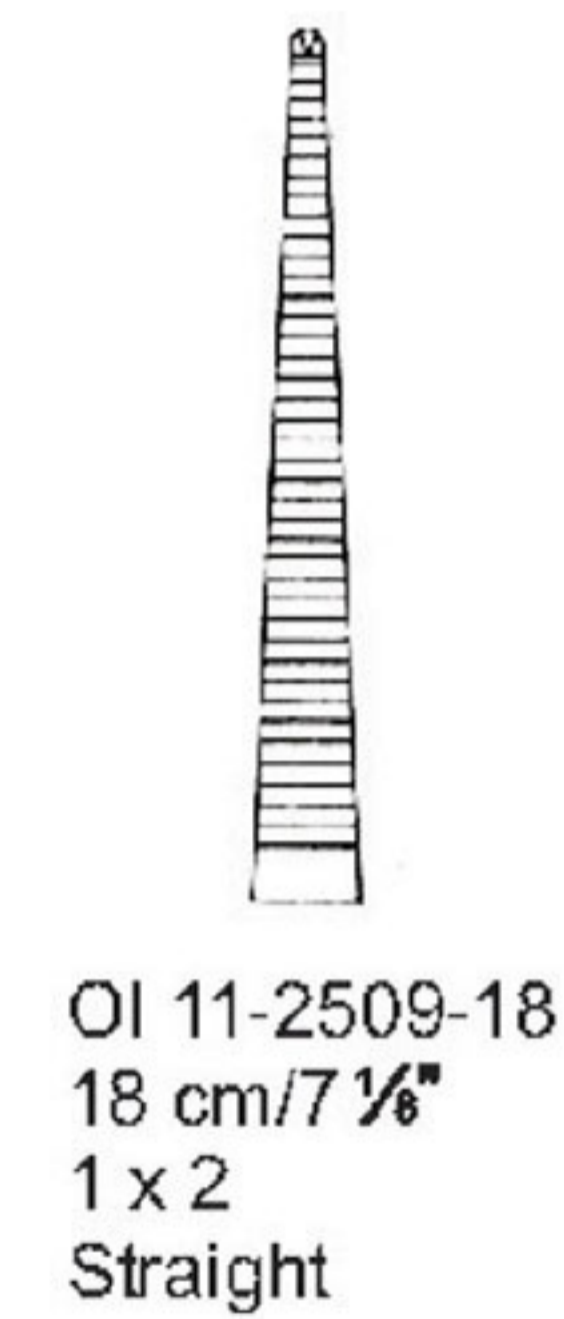
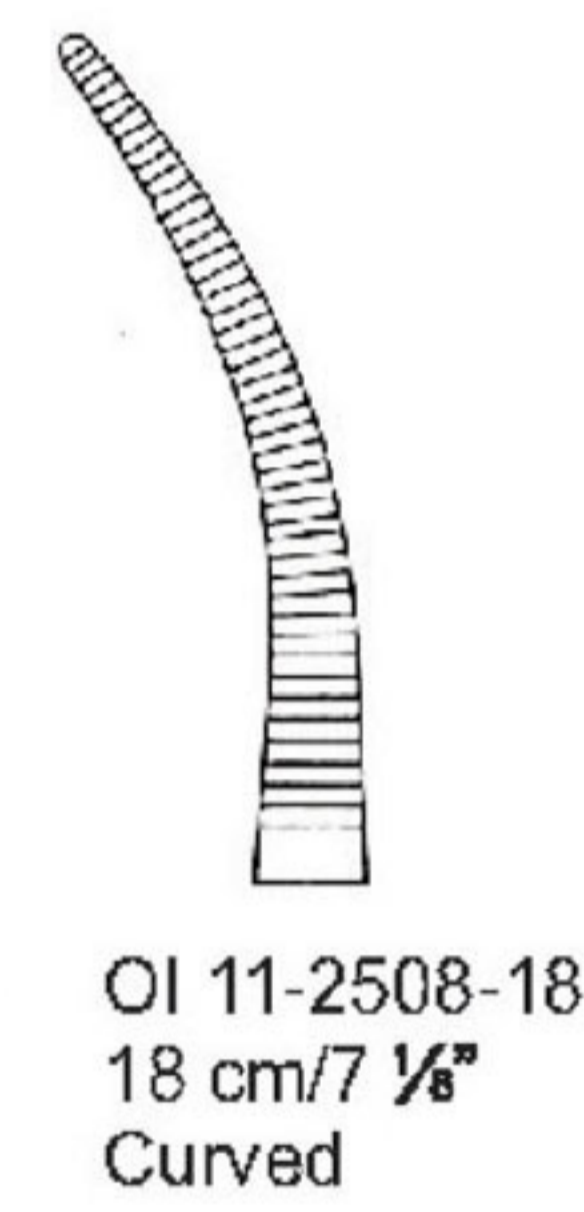
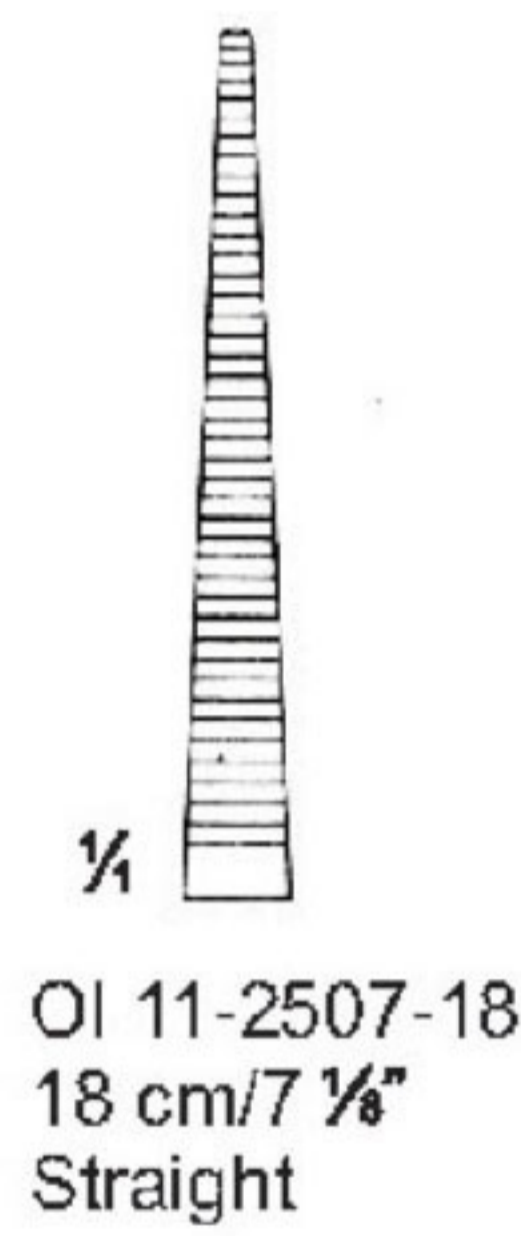

ARTERY FORCEPS

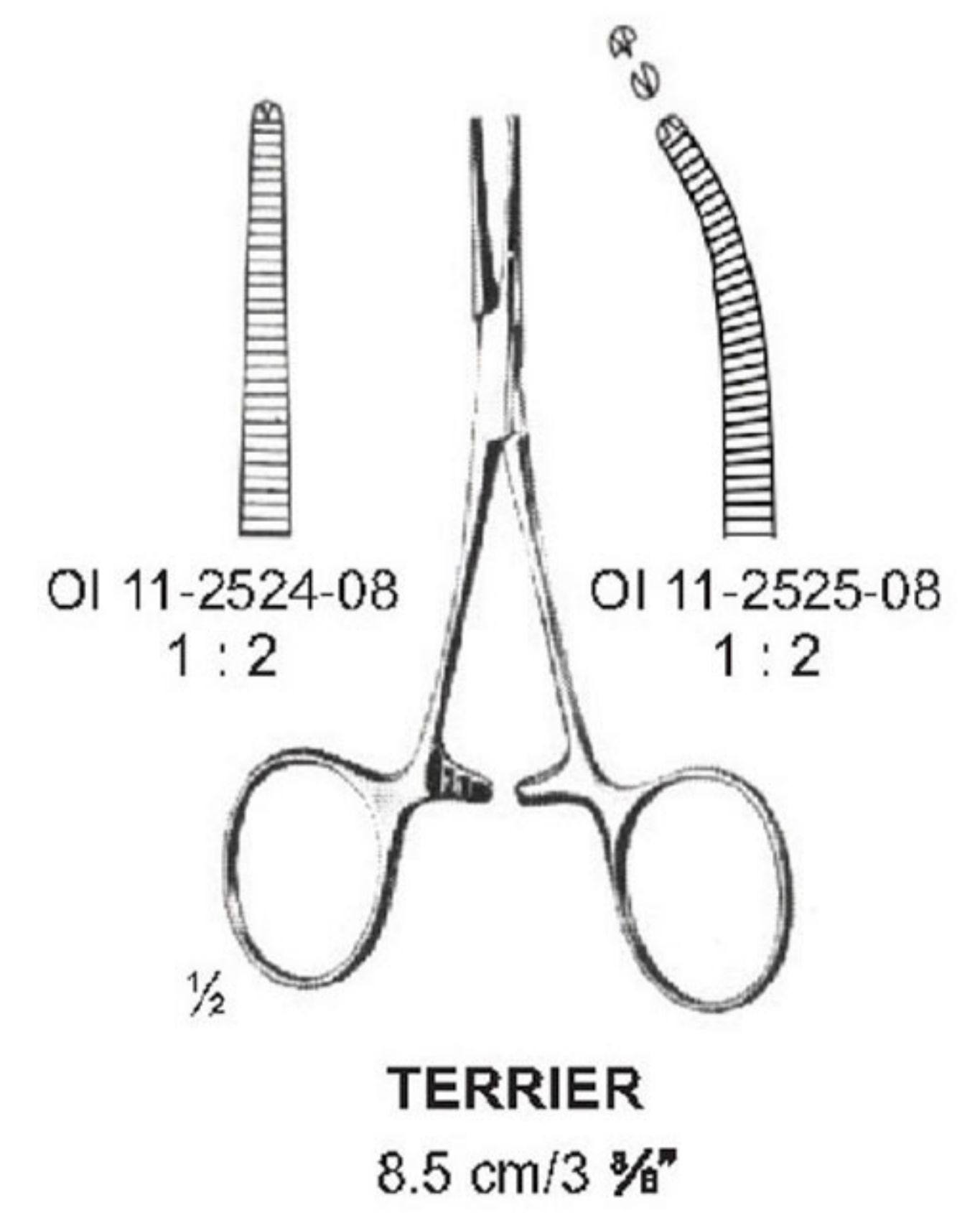
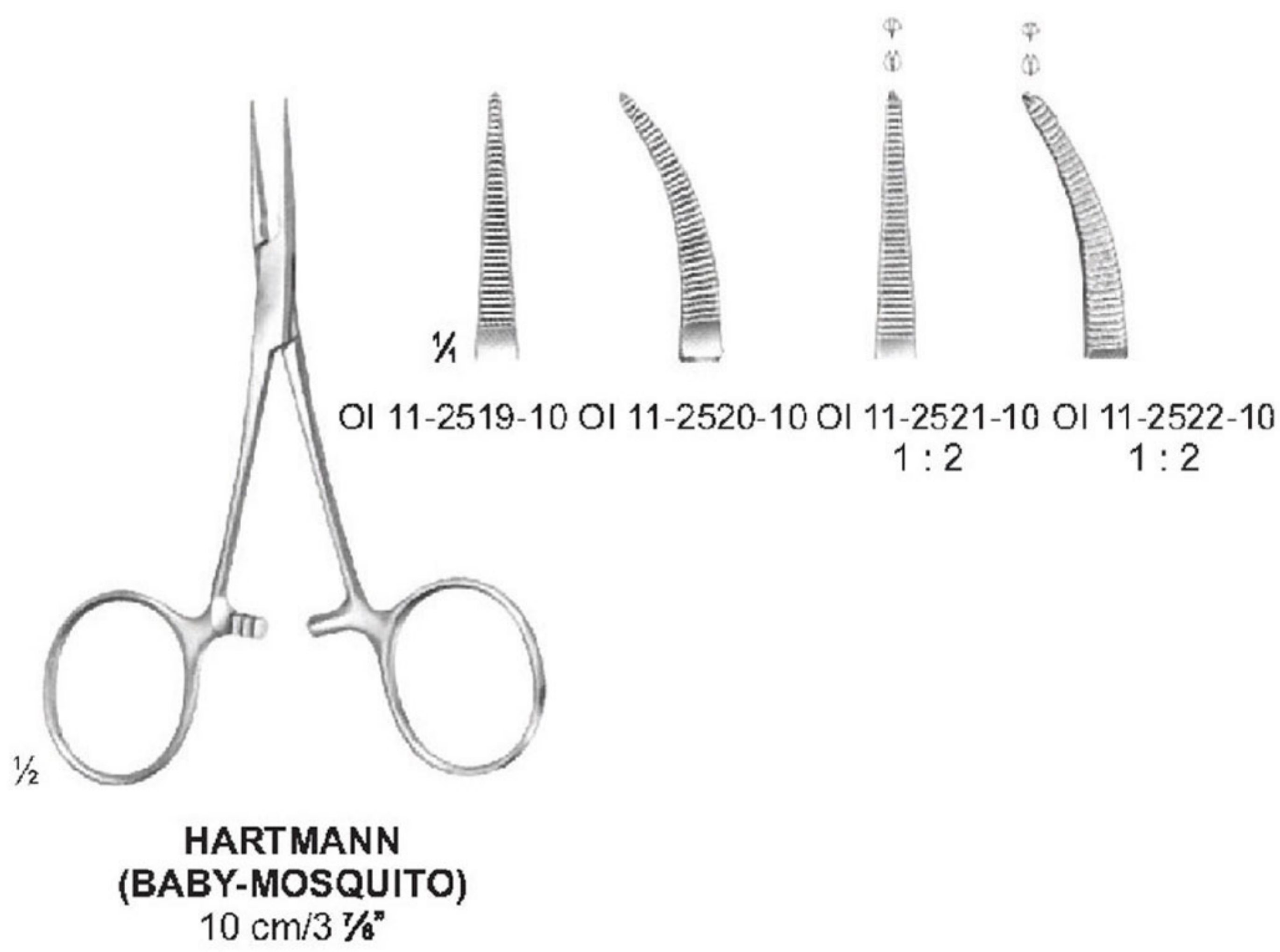
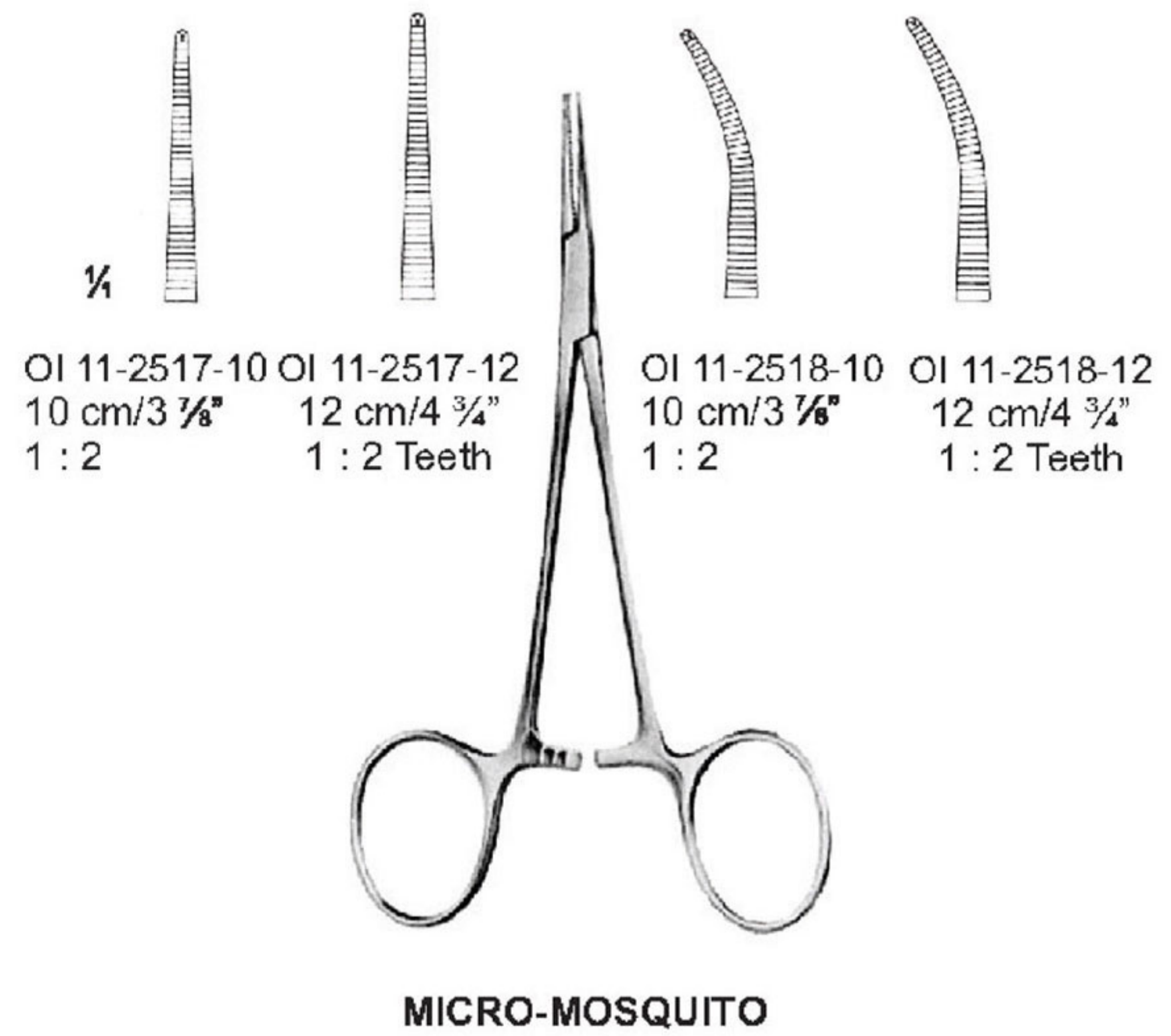
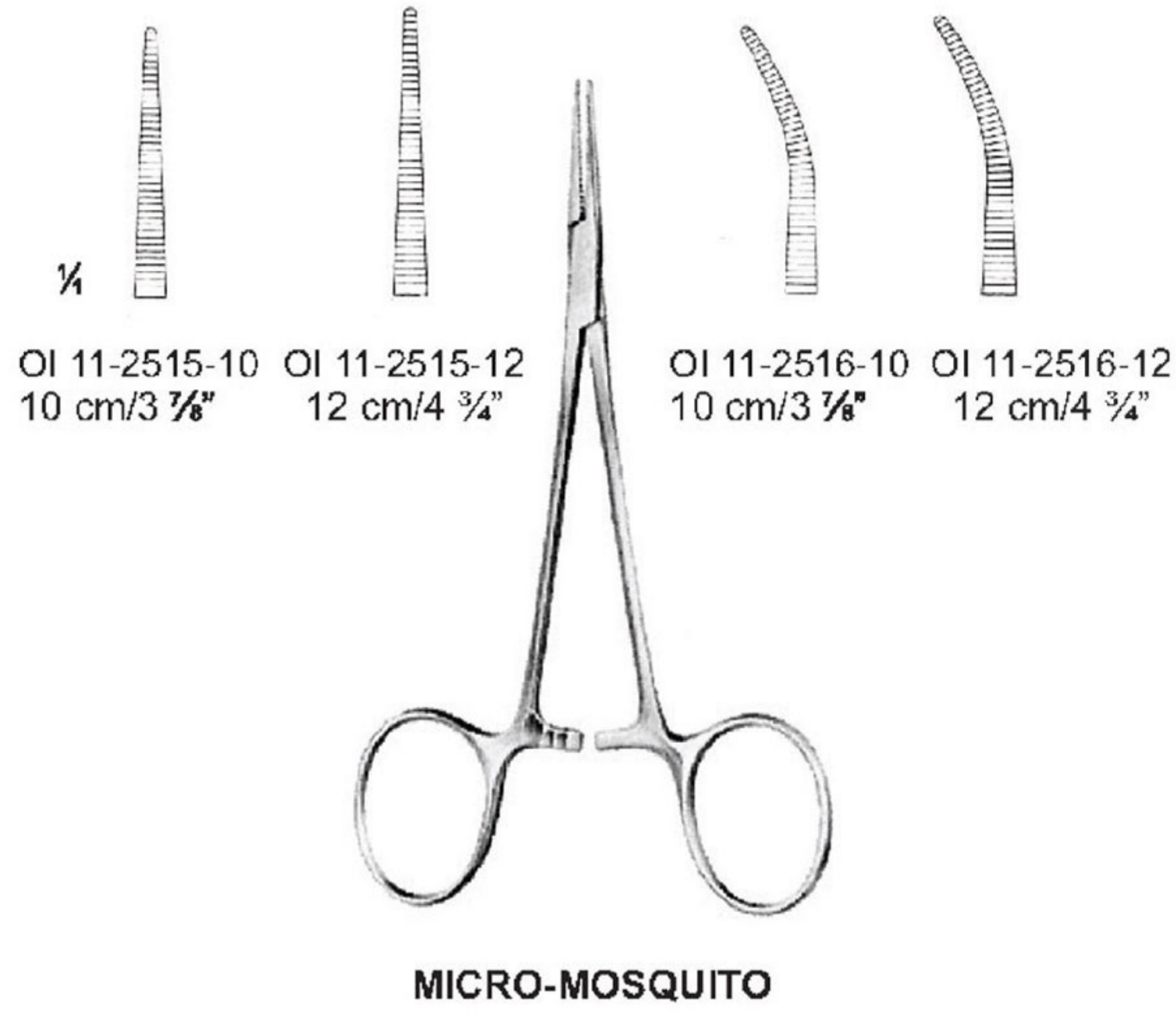

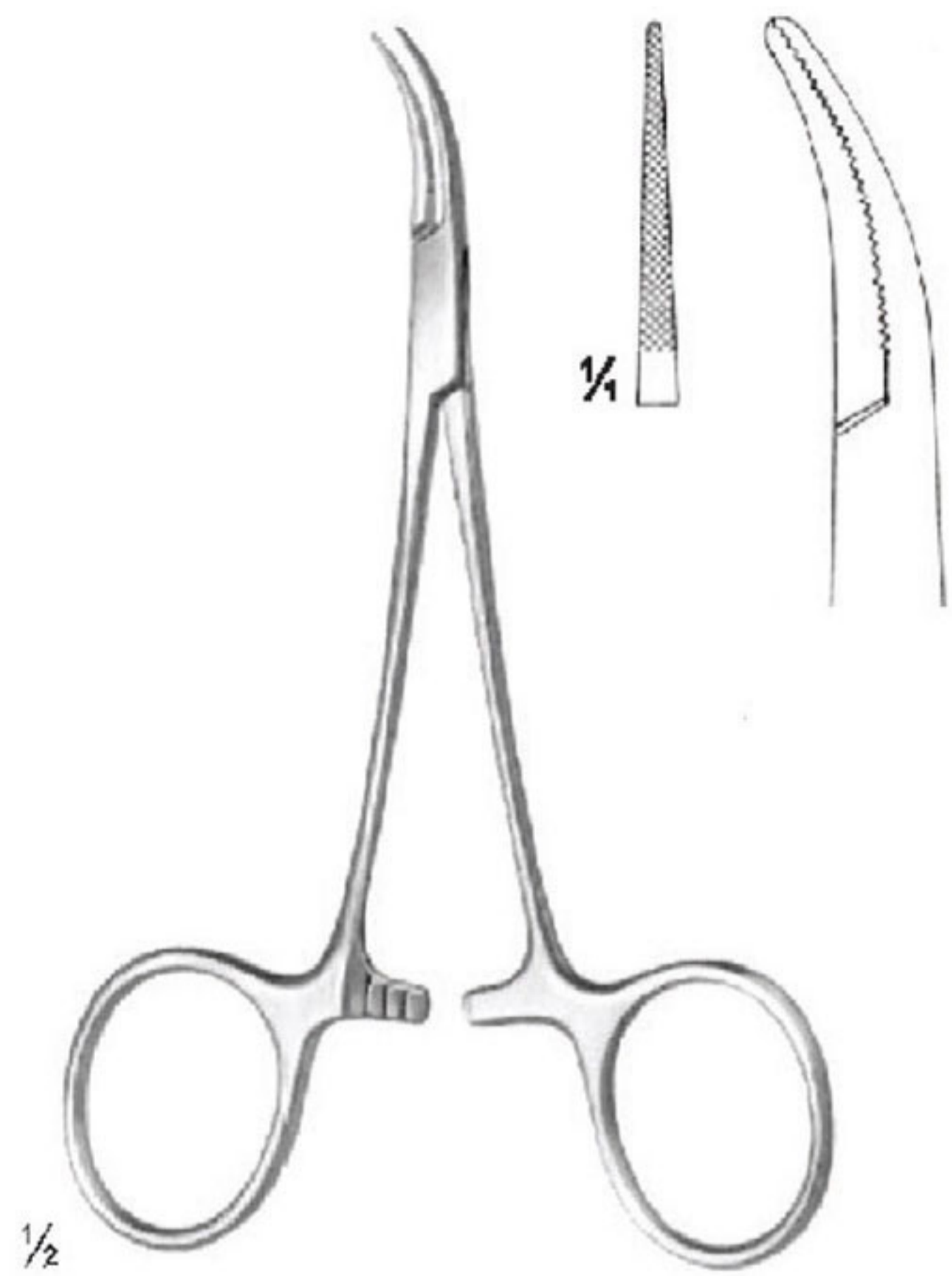

MOSQUITO-DANDY
OI 11-2526-12
12 cm/4 3/4"

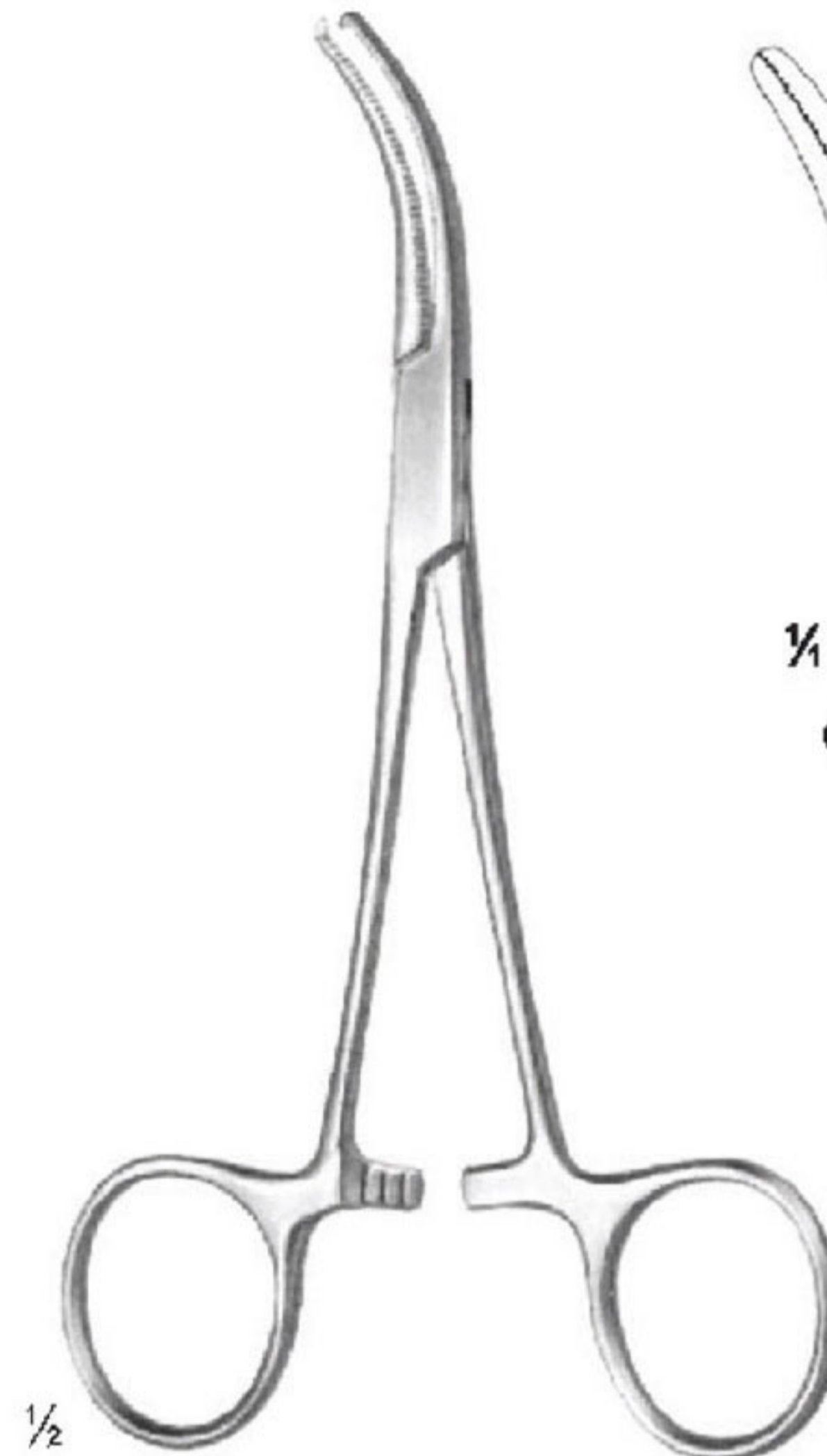

DANDY
14 cm/5 1/2"

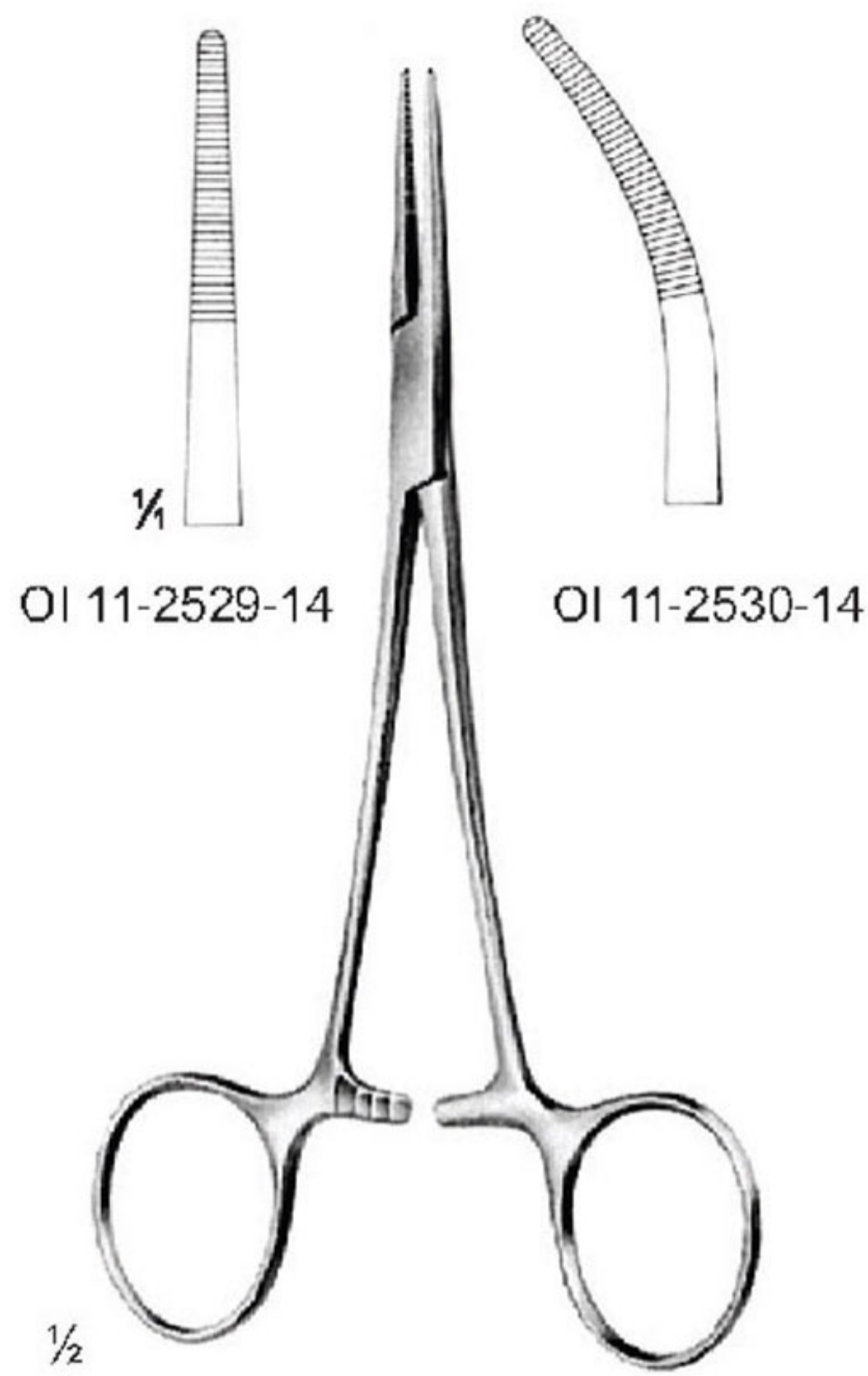
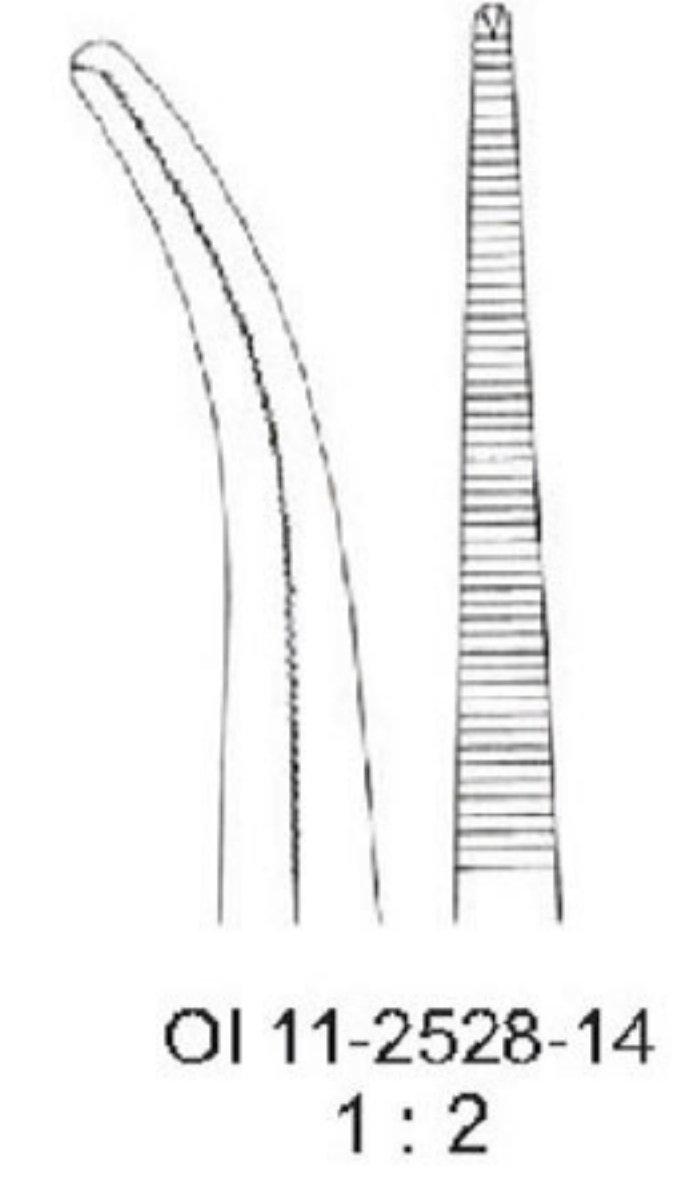
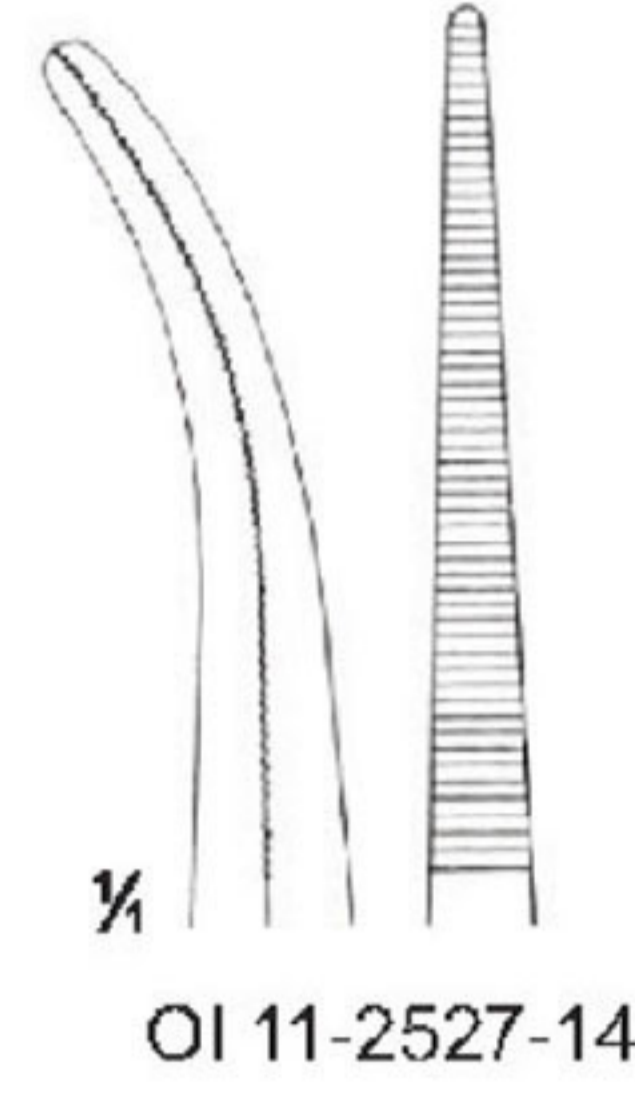

PROVIDENCE-HOSPITAL
14 cm/5 1/2"

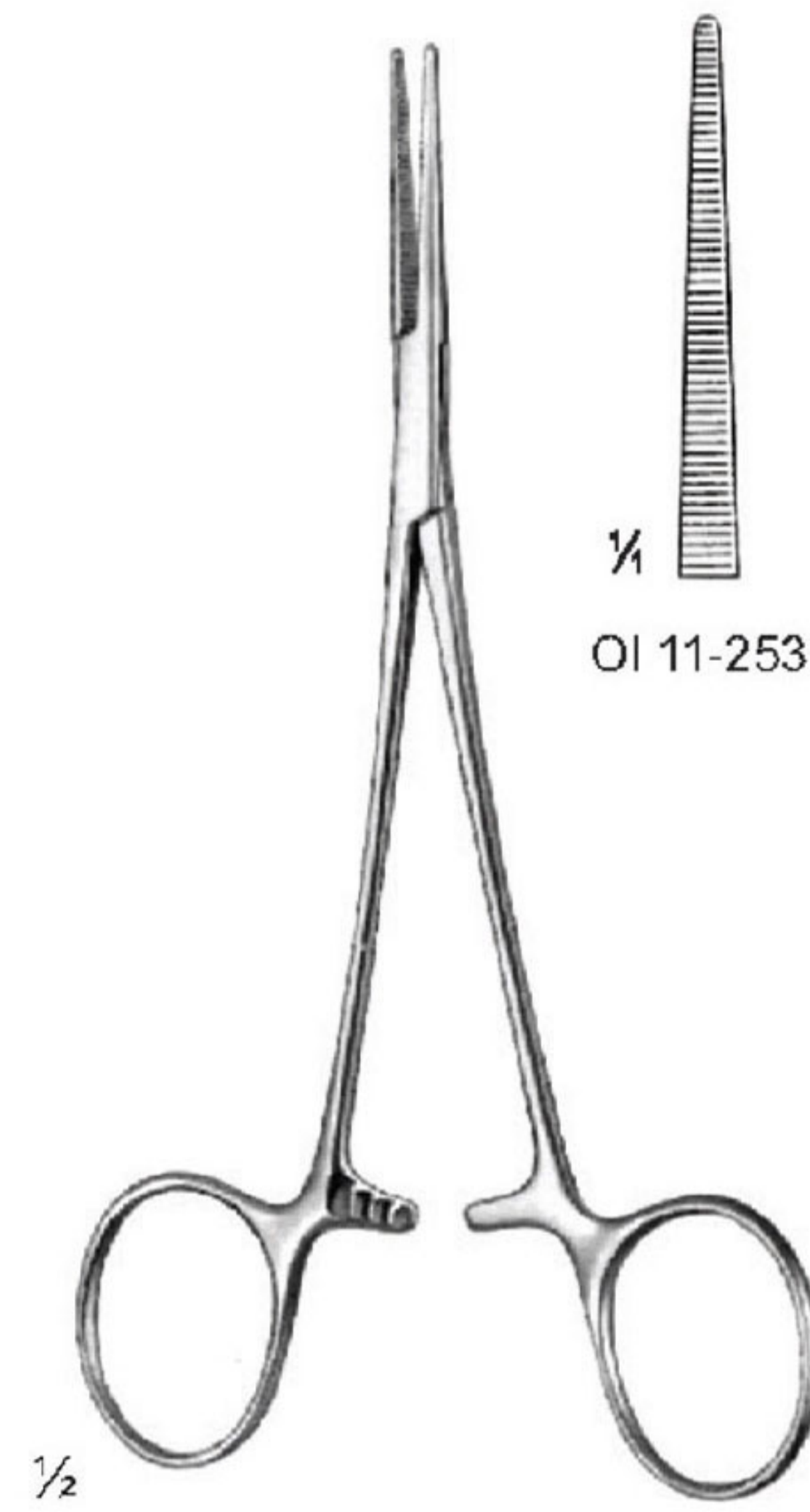

LERICHE
15 cm/5 7/8"

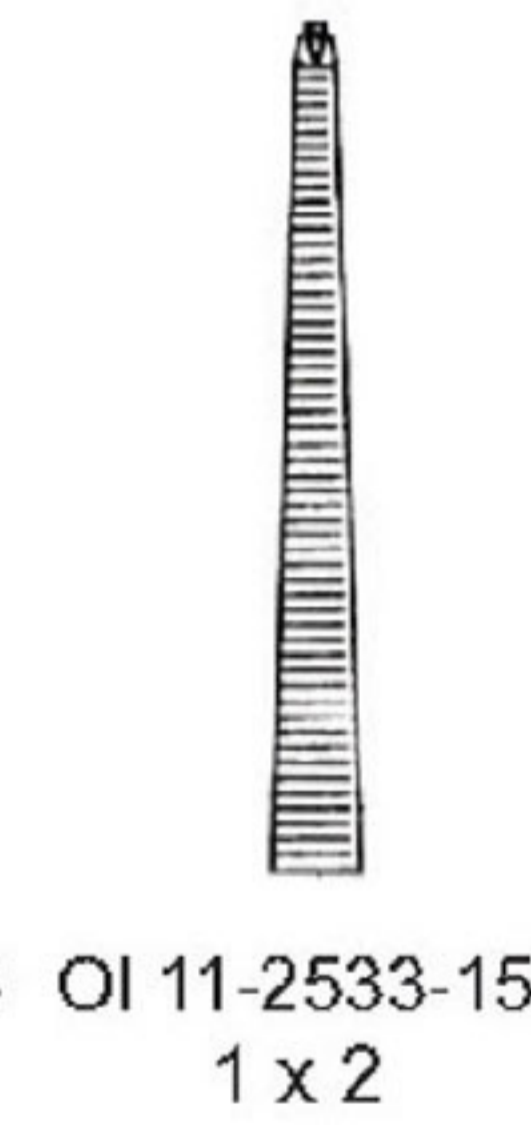
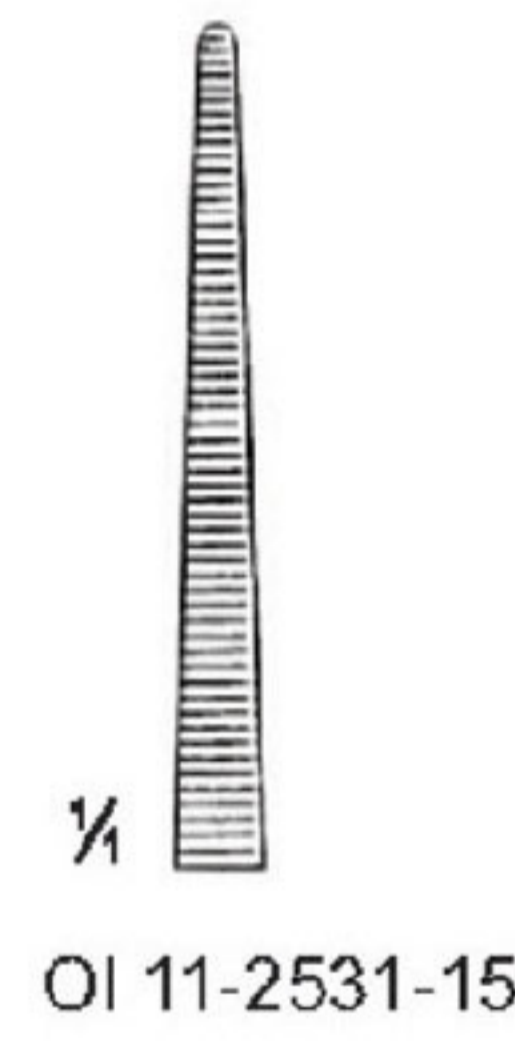

ARTERY FORCEPS

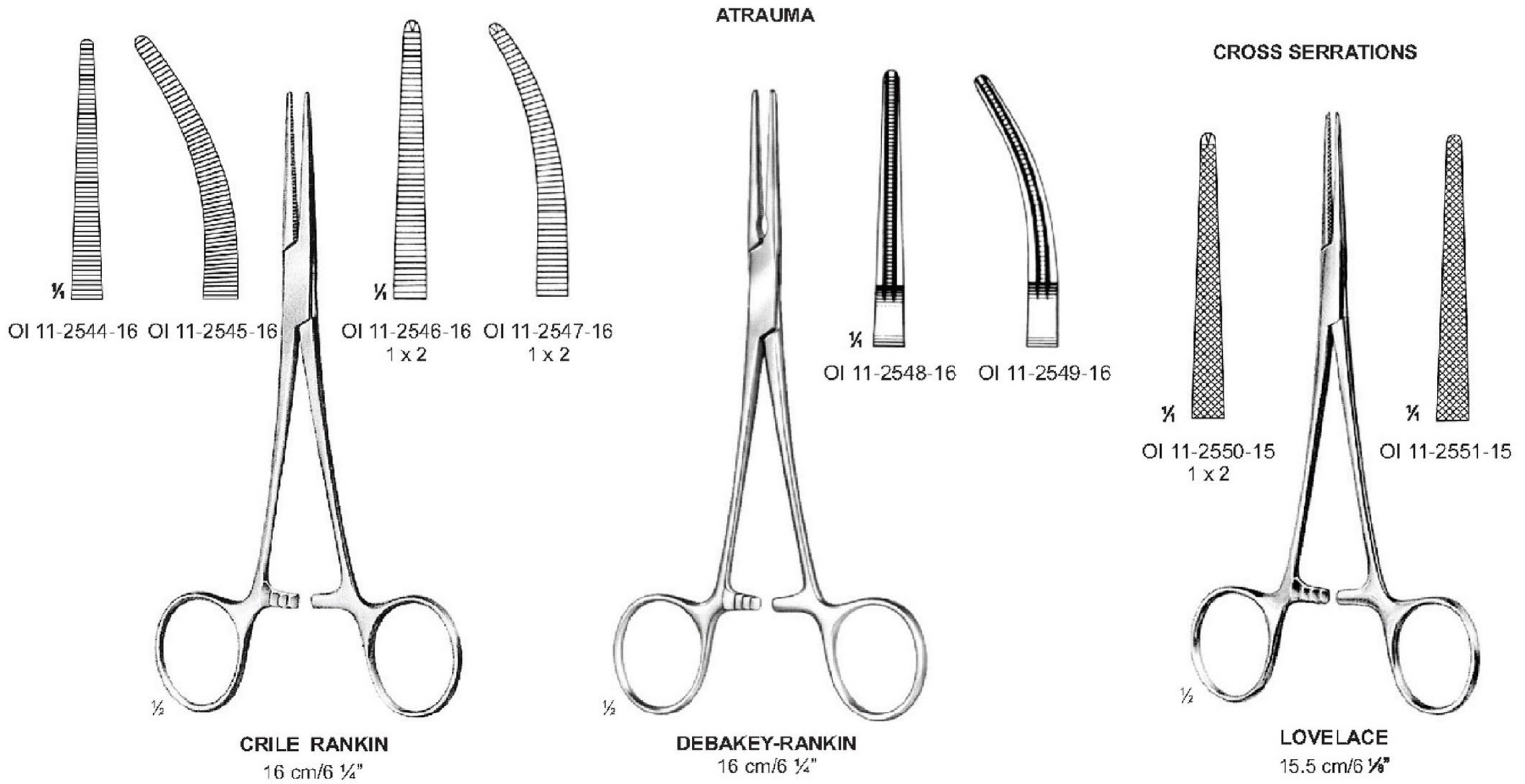
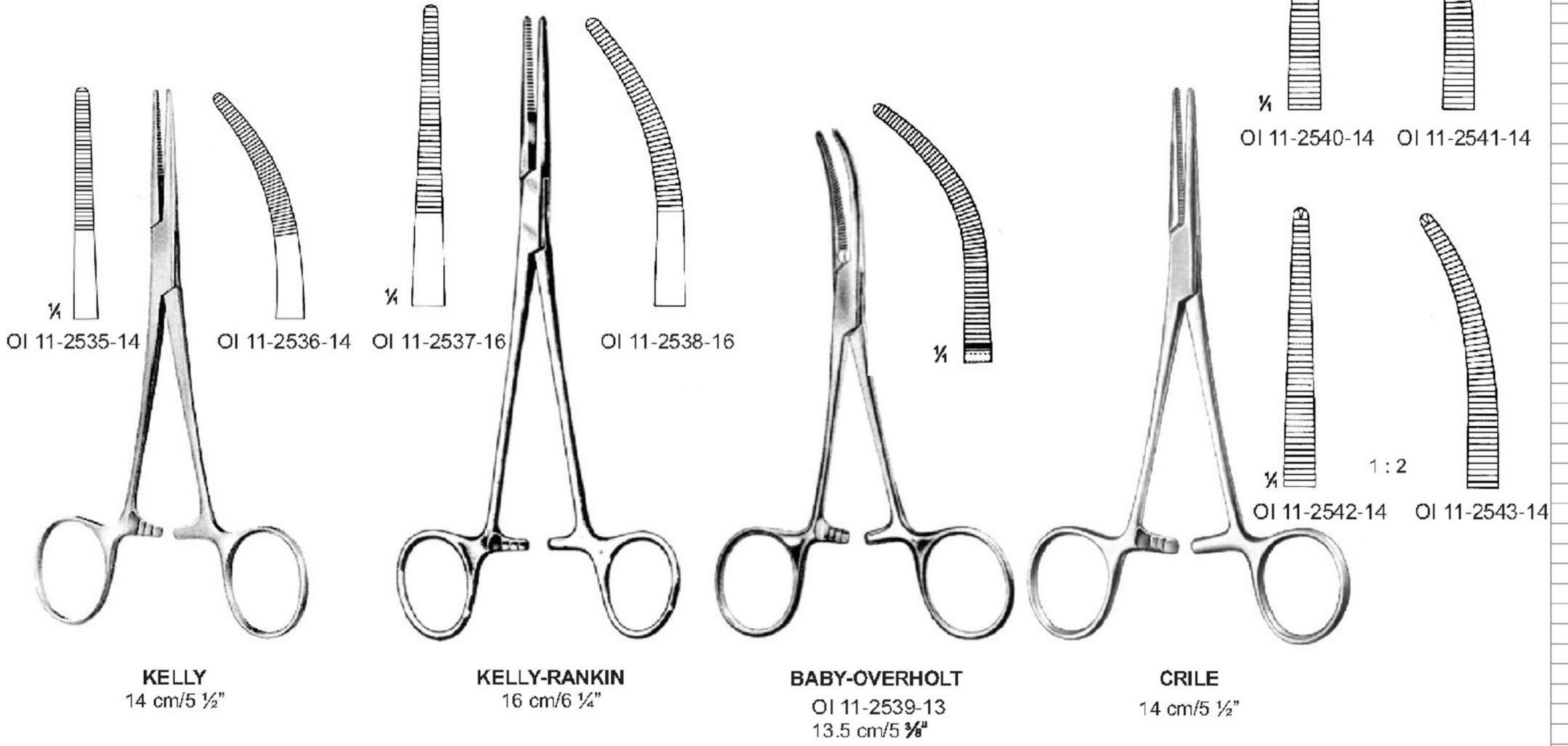



SPENCER-WELLS/JONES



OI 11-2552-13
13 cm/5 1/8"



OI 11-2552-14
14.5 cm/5 3/4"



OI 11-2552-15
15.5 cm/6 1/8"

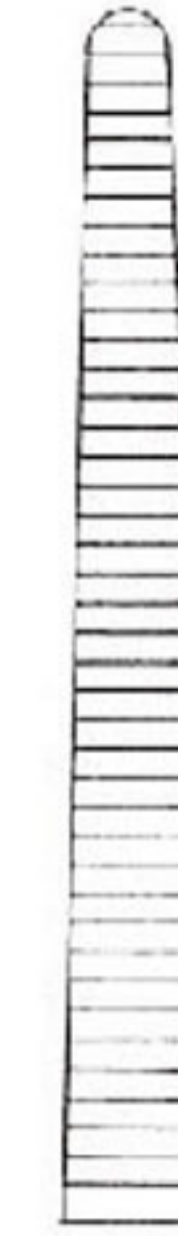

OI 11-2552-18
18.5 cm/7 1/4"



OI 11-2552-20
20 cm/7 7/8"



OI 11-2553-13
13 cm/5 1/8"



OI 11-2553-14
14 cm/5 1/2"



OI 11-2553-15
15 cm/5 7/8"



OI 11-2553-18
18 cm/7 1/8"



OI 11-2553-20
20 cm/7 7/8"

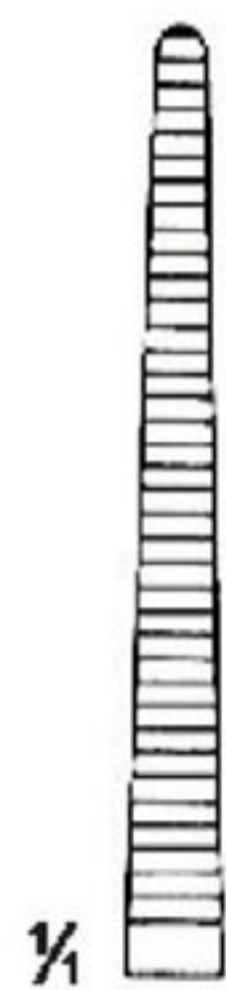

OI 11-2554-13
13.5 cm/5 3/8"

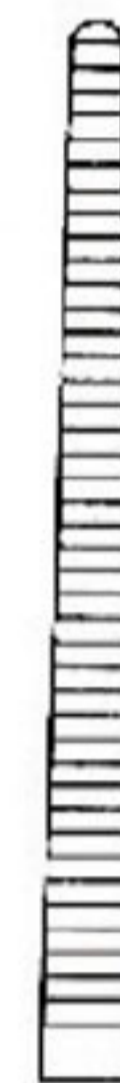

OI 11-2554-14
14.5 cm/5 3/4"

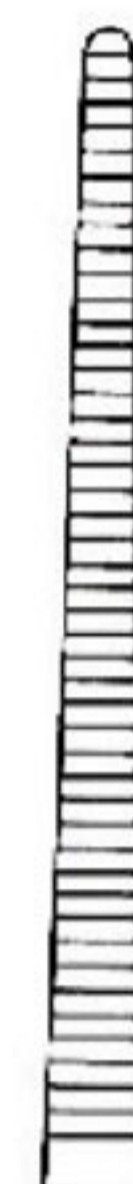

OI 11-2554-17
17 cm/6 3/4"



OI 11-2555-13
13 cm/5 1/8"



OI 11-2555-14
14 cm/5 1/2"



OI 11-2555-16
16.5 cm/6 1/2"

Cm	In	Straight
18	7 1/8"	OI 11-2557-18
20	7 7/8"	OI 11-2557-20
22	8 1/2"	OI 11-2557-22
24	9 1/2"	OI 11-2557-24
26	10 1/4"	OI 11-2557-26
28	11"	OI 11-2557-28

Curved
OI 11-2558-18
OI 11-2558-20
OI 11-2558-22
OI 11-2558-24
OI 11-2558-26
OI 11-2558-28



OI 11-2559-18
1 x 2

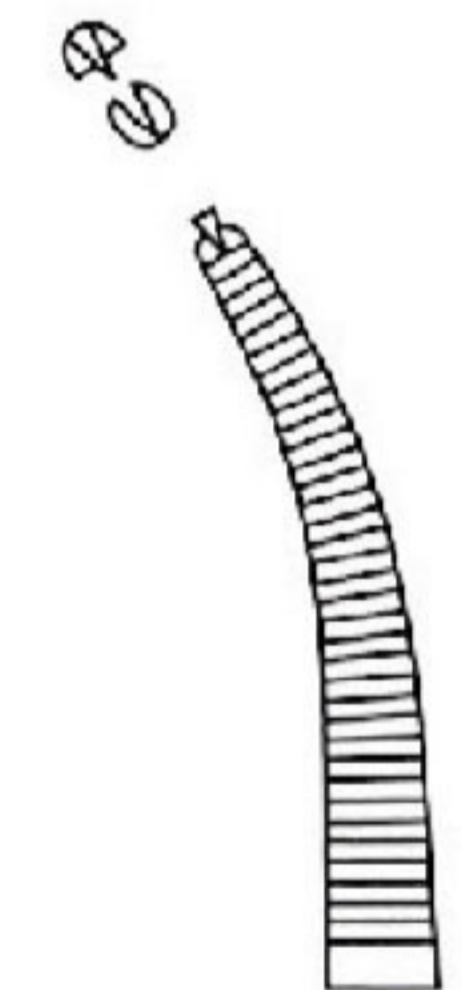

OI 11-2560-18
1 x 2

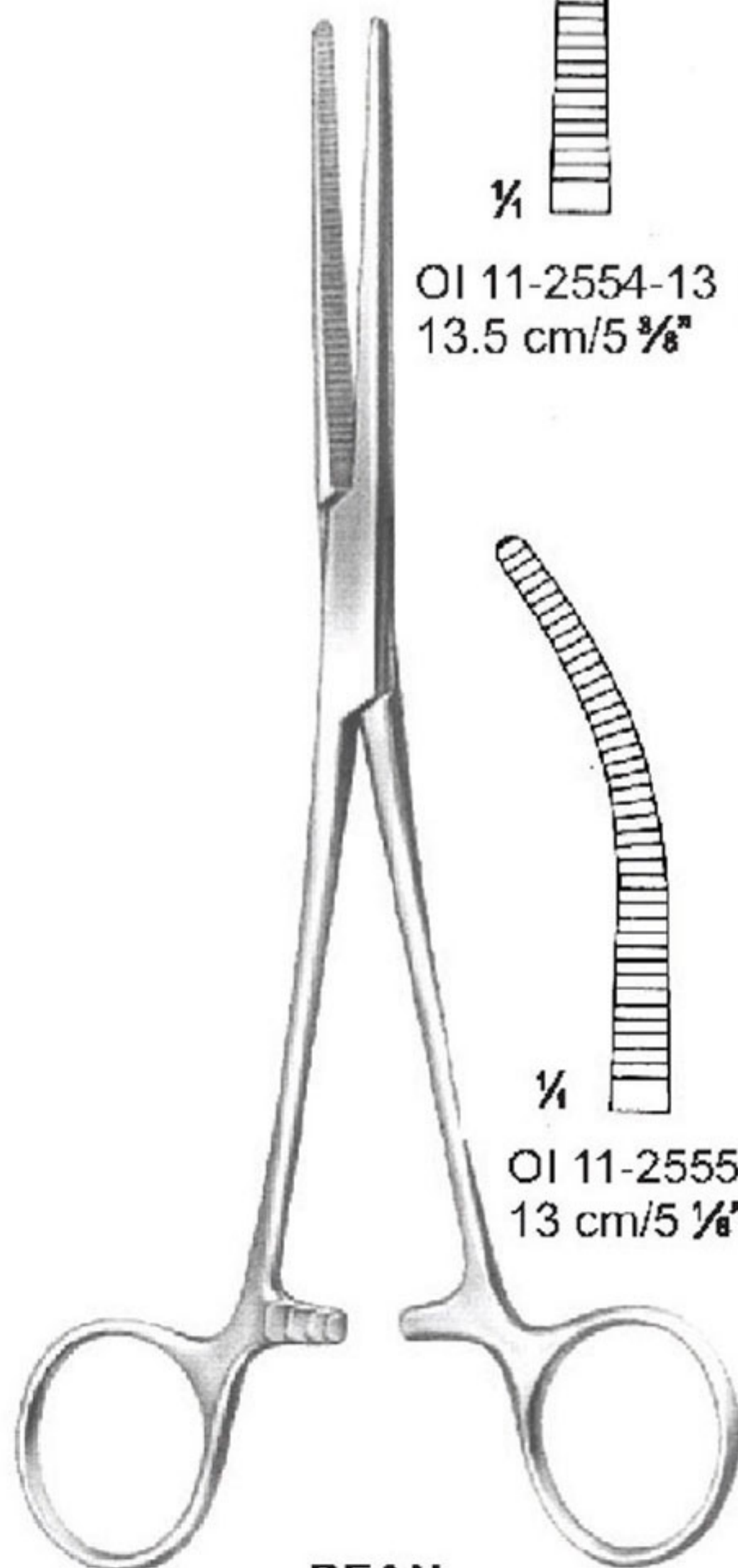

PEAN
DELICATE PATTERN

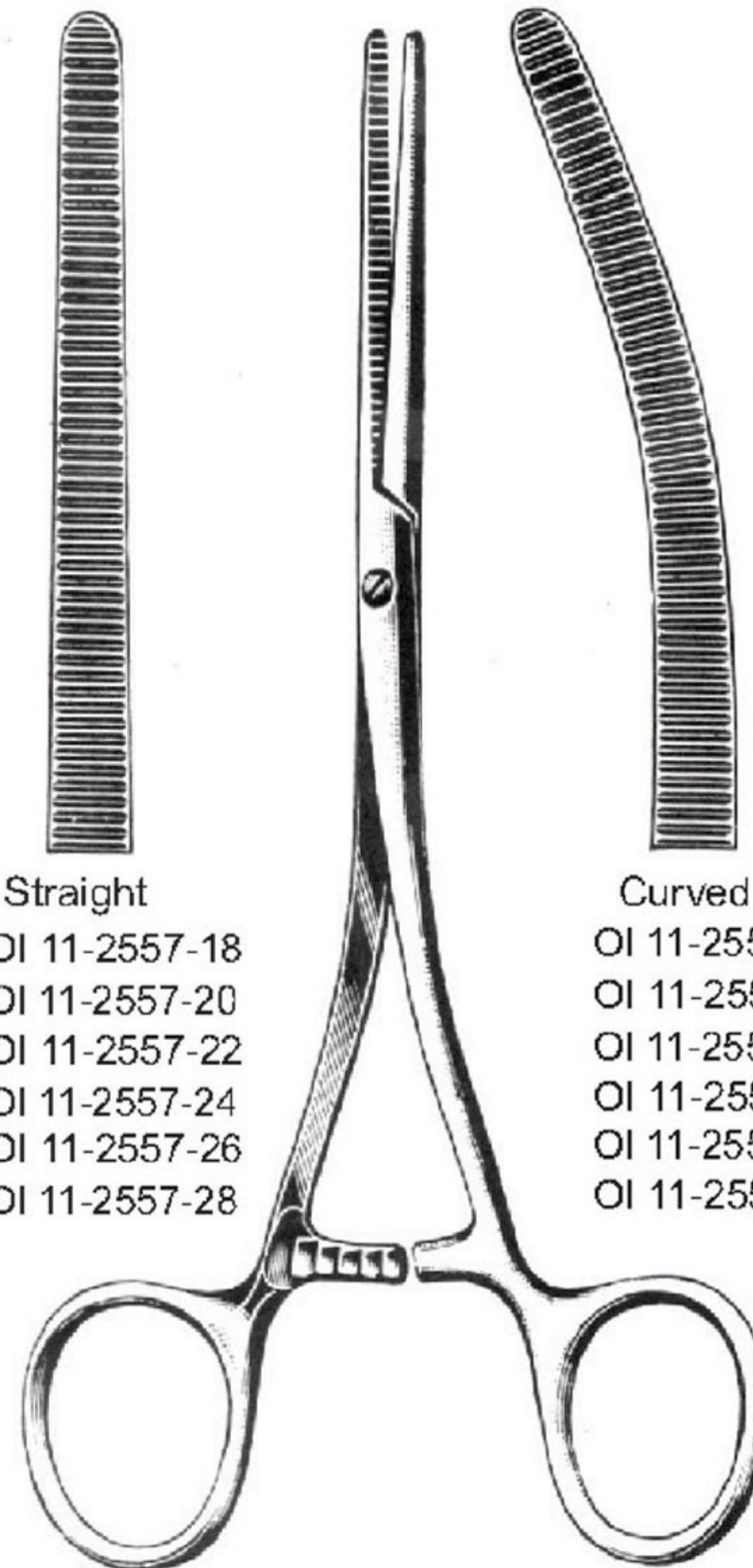

PEAN

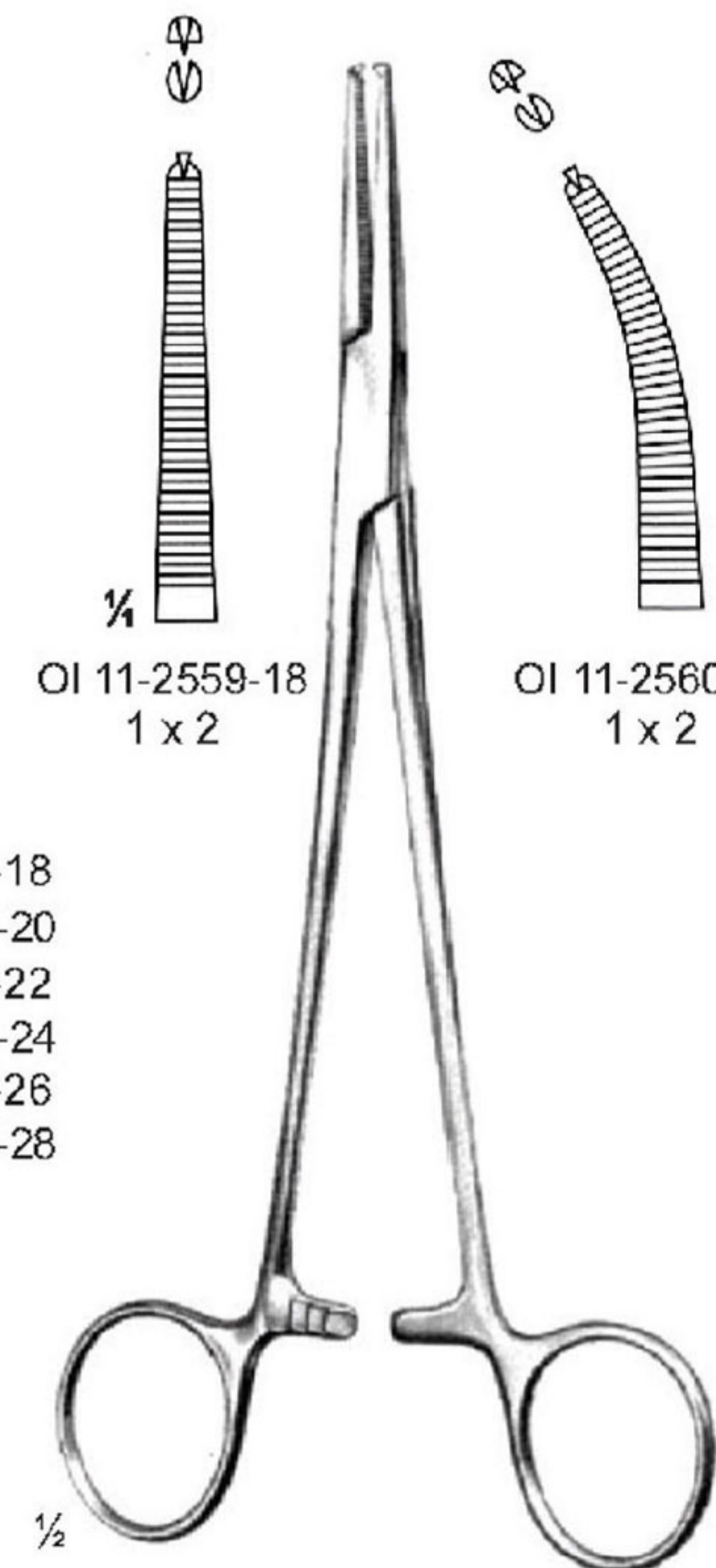

ADSON
18.5 cm/7 1/4"

ARTERY FORCEPS

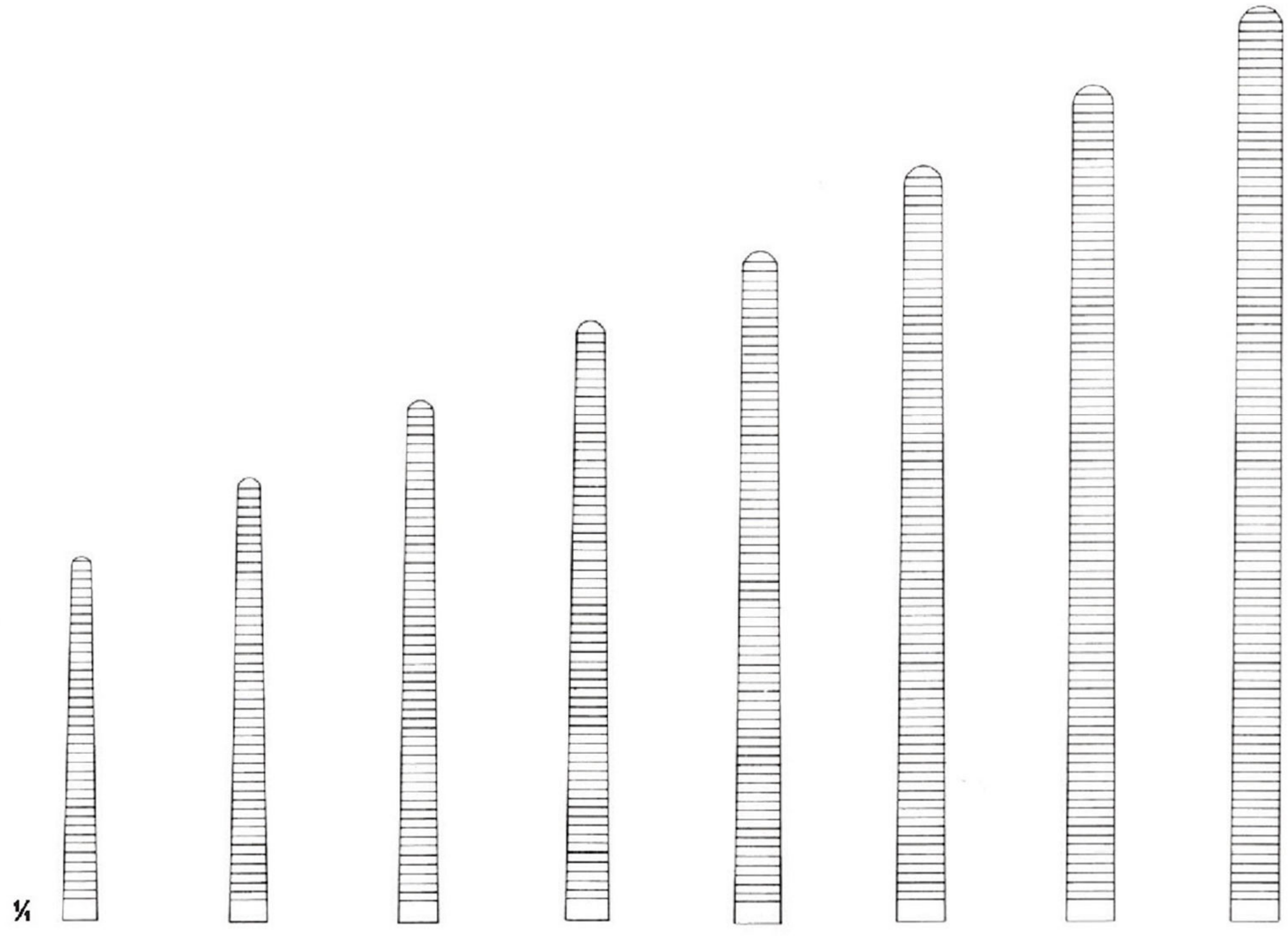

OI 11-2561-14 14.5 cm/5 3/4"
 OI 11-2561-16 16.5 cm/6 1/2"
 OI 11-2561-18 18.5 cm/7 1/4"
 OI 11-2561-20 20.5 cm/8 1/8"
 OI 11-2561-22 22.5 cm/8 3/4"
 OI 11-2561-24 24.5 cm/9 5/8"
 OI 11-2561-26 26 cm/10 1/4"
 OI 11-2561-30 30.5 cm/12"



ROCHESTER-PEAN

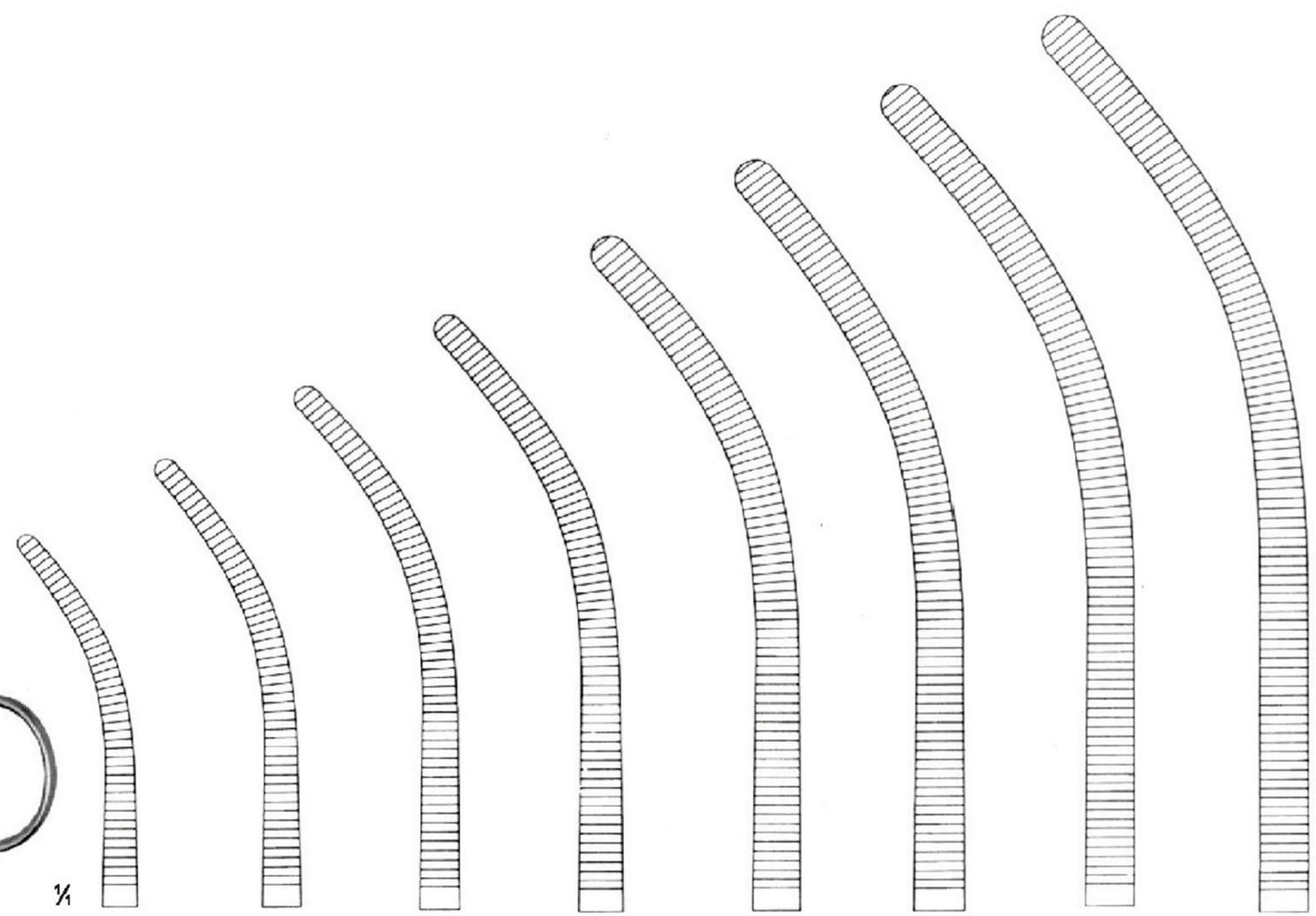

OI 11-2562-14 14.5 cm/5 3/4"
 OI 11-2562-16 16.5 cm/6 1/2"
 OI 11-2562-18 18.5 cm/7 1/4"
 OI 11-2562-20 20.5 cm/8 1/8"
 OI 11-2562-22 22.5 cm/8 3/4"
 OI 11-2562-24 24.5 cm/9 5/8"
 OI 11-2562-26 26 cm/10 1/4"
 OI 11-2562-30 30.5 cm/12"





ATRAUMA

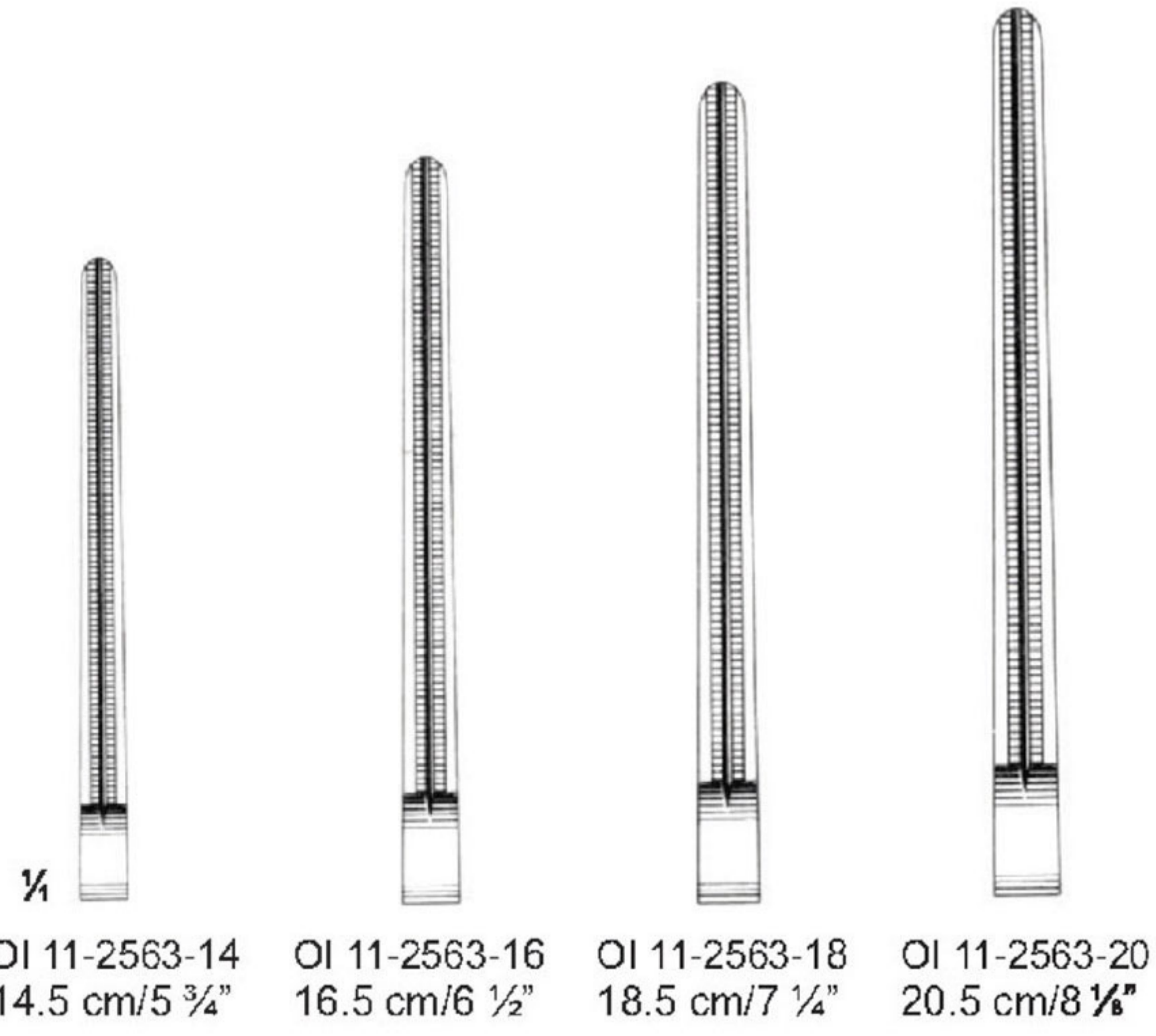
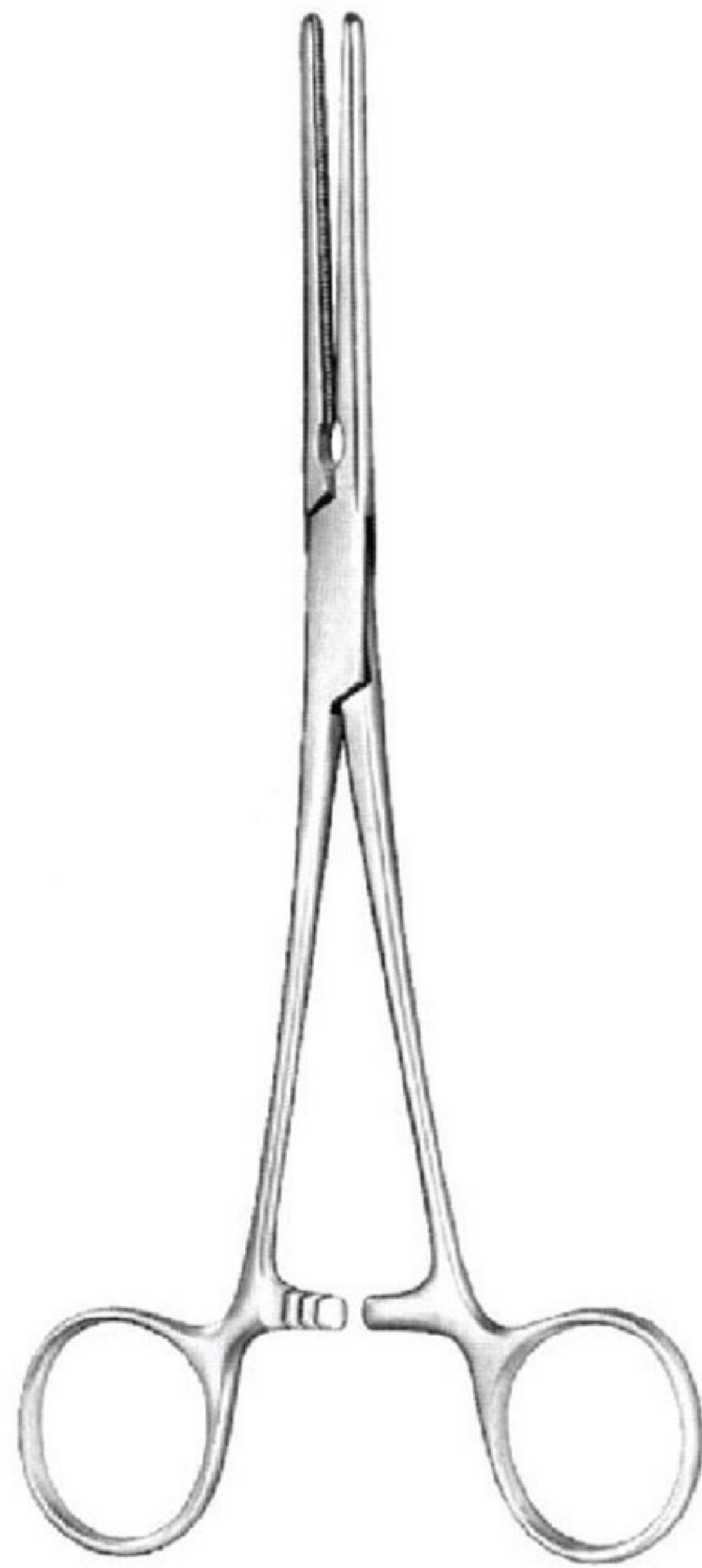

- 1/4
- OI 11-2563-14 14.5 cm/5 3/4"
- OI 11-2563-16 16.5 cm/6 1/2"
- OI 11-2563-18 18.5 cm/7 1/4"
- OI 11-2563-20 20.5 cm/8 1/8"

DEBAKEY-PEAN

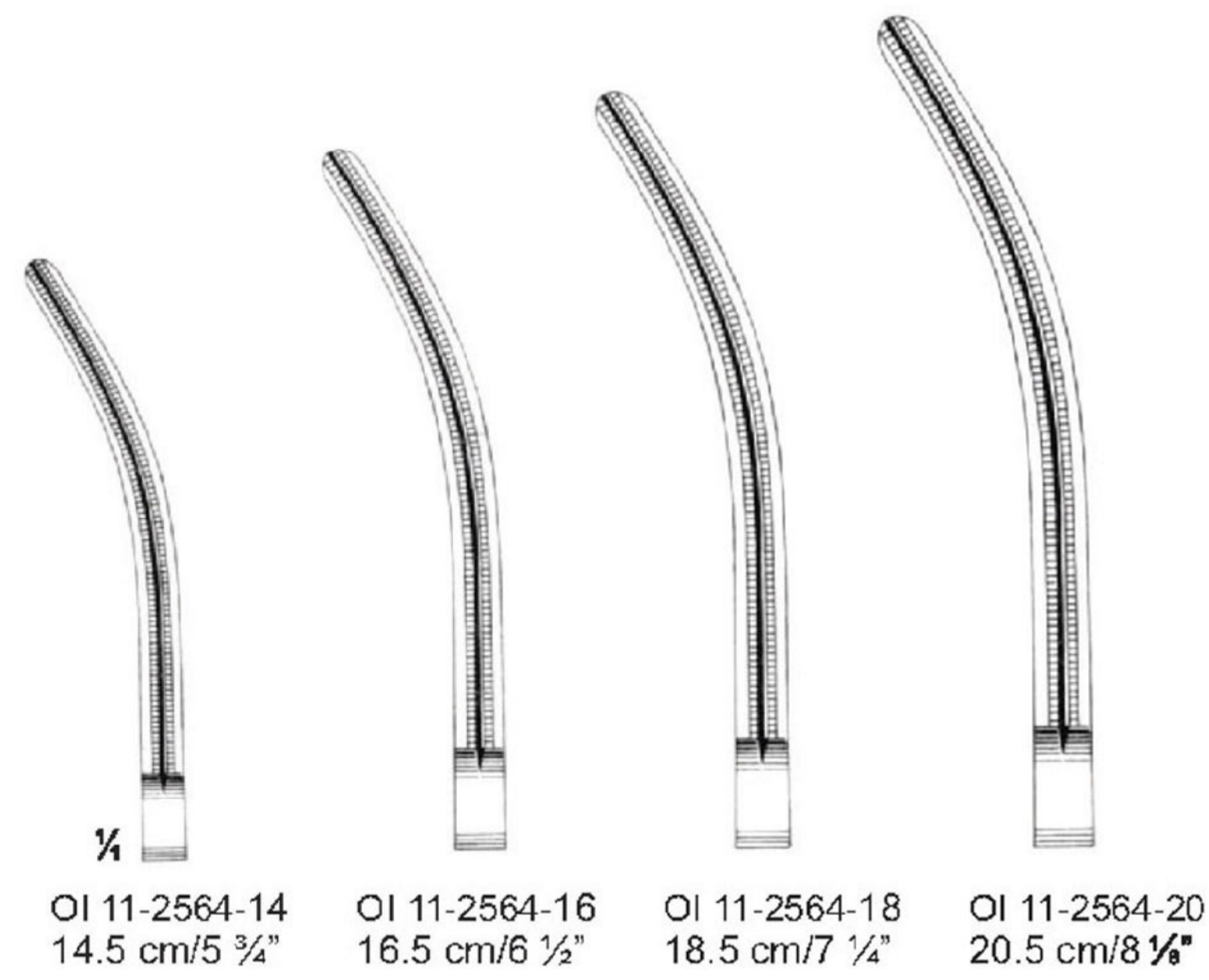

- 1/4
- OI 11-2564-14 14.5 cm/5 3/4"
- OI 11-2564-16 16.5 cm/6 1/2"
- OI 11-2564-18 18.5 cm/7 1/4"
- OI 11-2564-20 20.5 cm/8 1/8"

DEBAKEY-PEAN

ARTERY FORCEPS

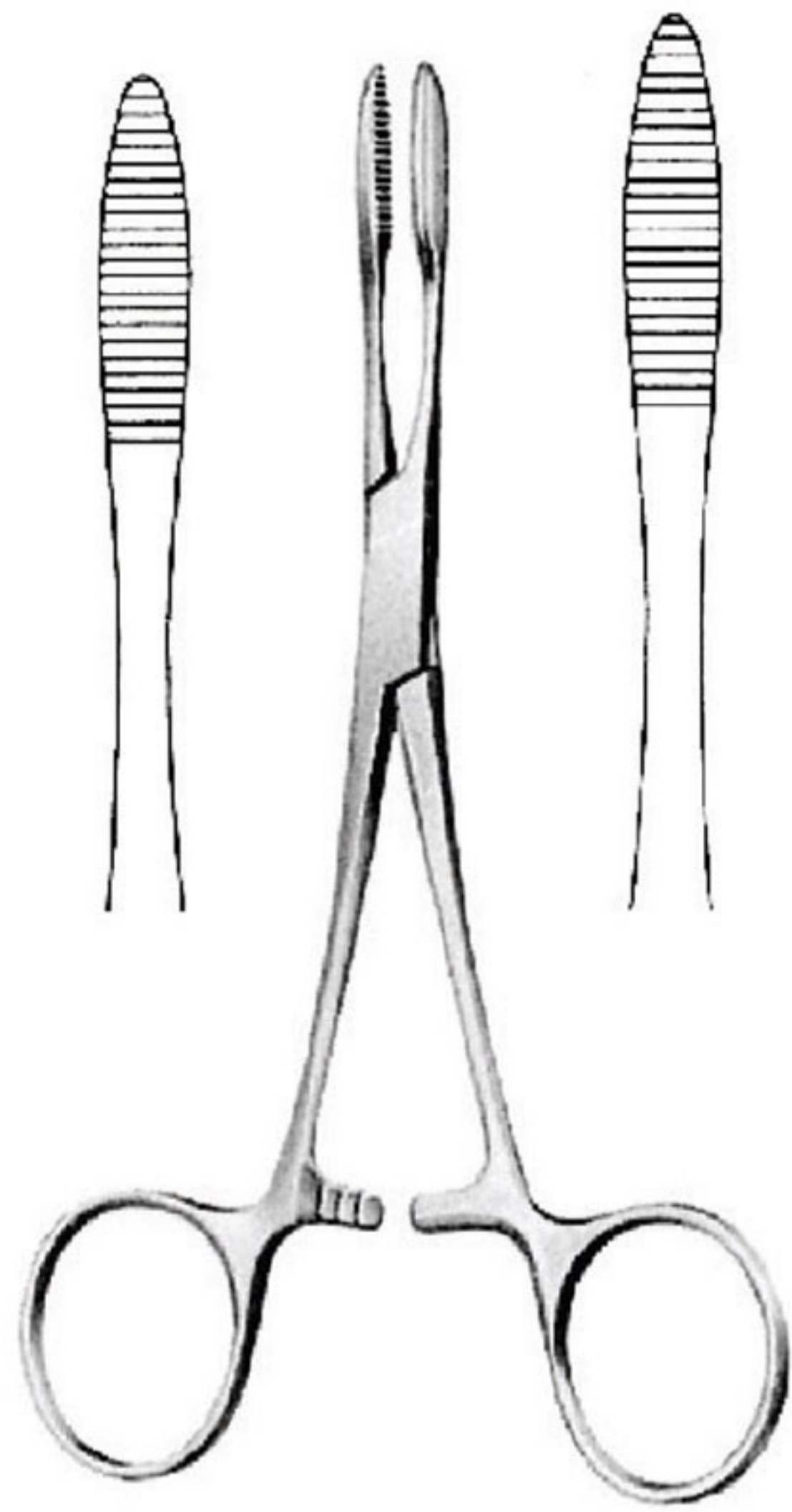

PEAN
 OI 11-2565-14 14 cm/5 1/2"
 OI 11-2565-16 16 cm/6 1/4"



KOCHER
 Delicate Pattern
 1 : 2

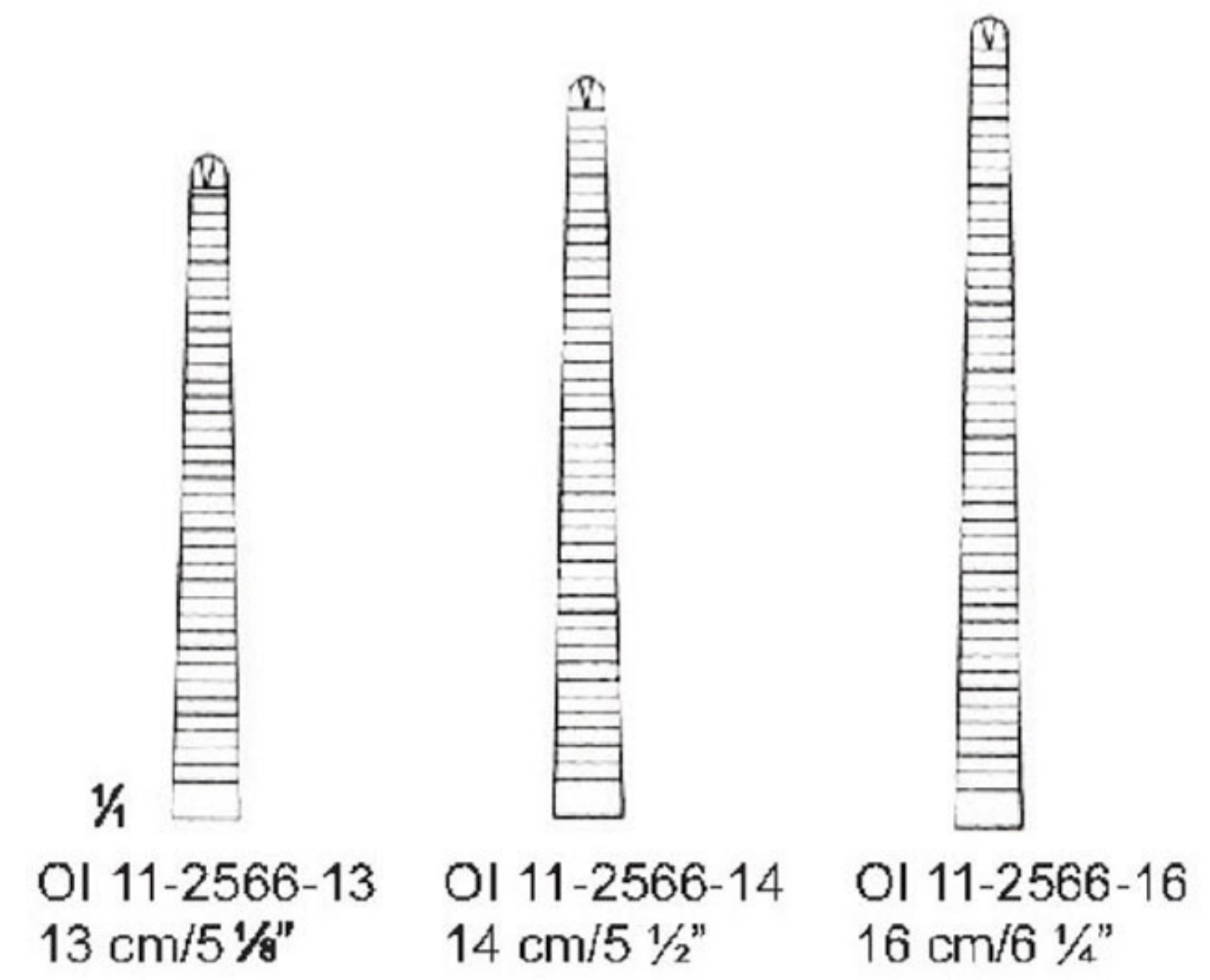

OI 11-2566-13 13 cm/5 1/8"
 OI 11-2566-14 14 cm/5 1/2"
 OI 11-2566-16 16 cm/6 1/4"

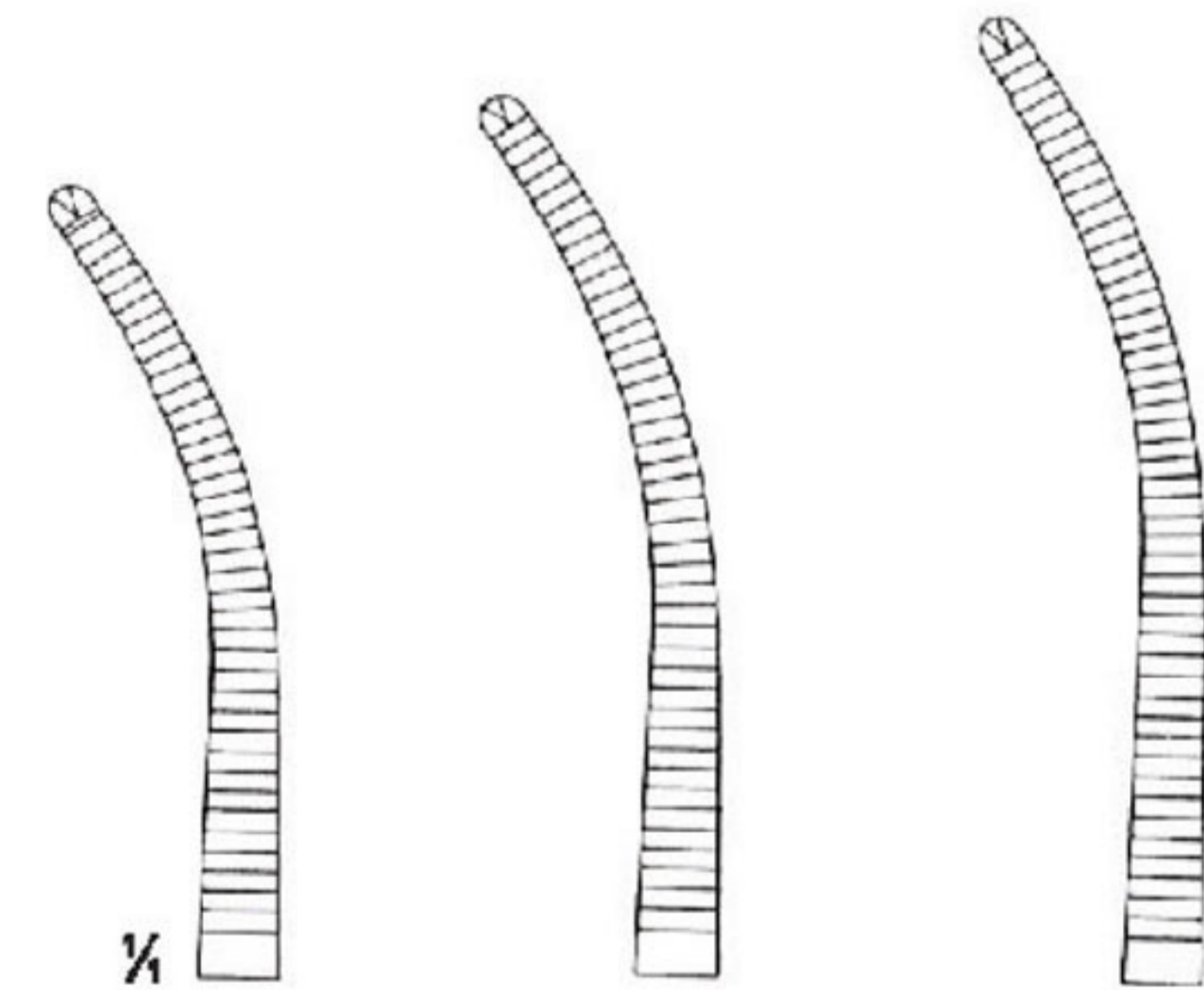

OI 11-2567-13 13 cm/5 1/8"
 OI 11-2567-14 14 cm/5 1/2"
 OI 11-2567-16 16 cm/6 1/4"

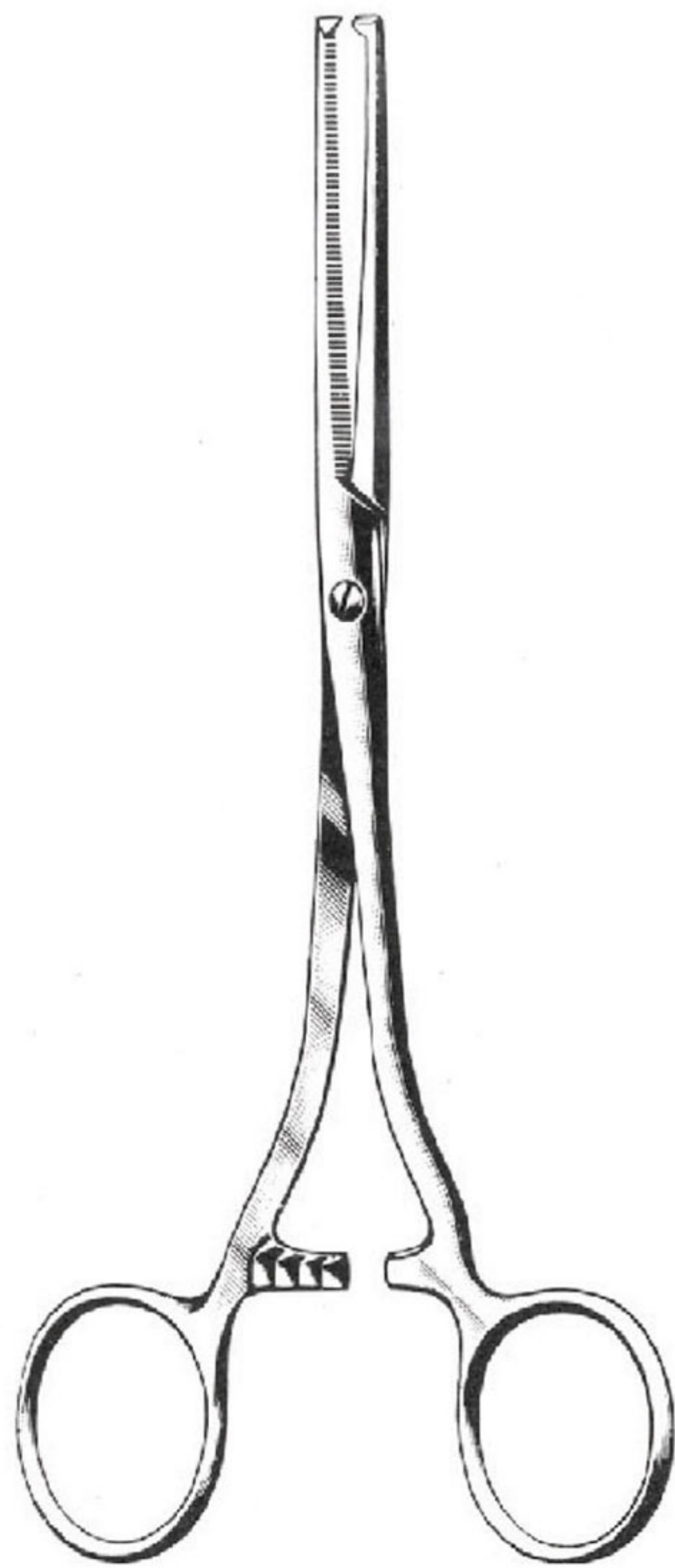

KOCHER



1 x 2

OI 11-2568-18 18 cm/7 1/8"
 OI 11-2568-20 20 cm/7 7/8"
 OI 11-2568-22 22 cm/8 1/2"
 OI 11-2568-24 24 cm/9 1/2"
 OI 11-2568-26 26 cm/10 1/4"
 OI 11-2569-18
 OI 11-2569-20
 OI 11-2569-22
 OI 11-2569-24
 OI 11-2569-26

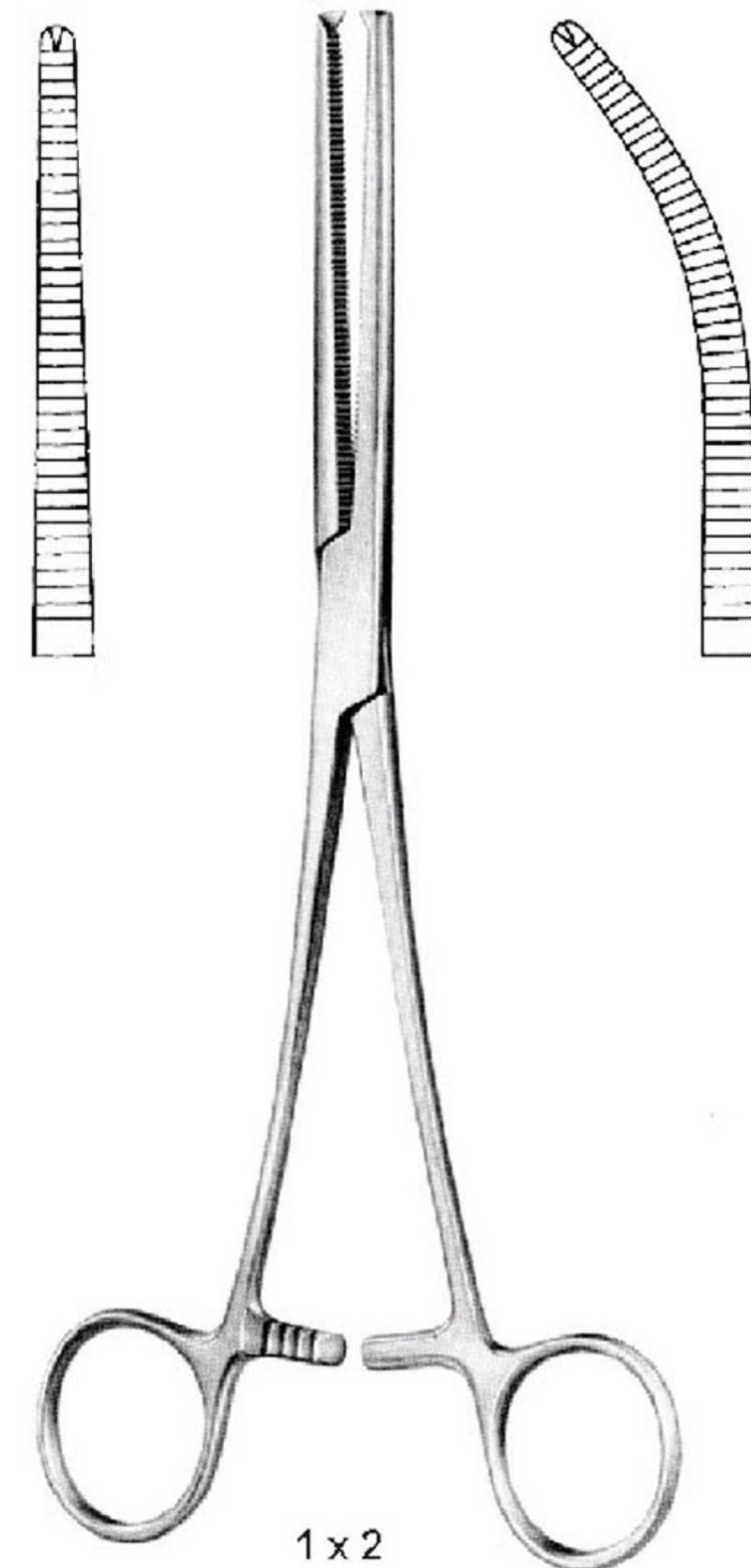

1 x 2

KOCHER (STANDARD)

OI 11-2570-13 13 cm/5 1/8"
 OI 11-2570-14 14 cm/5 1/2"
 OI 11-2571-14 14.5cm/5 3/4"
 OI 11-2572-13
 OI 11-2572-14
 OI 11-2573-14



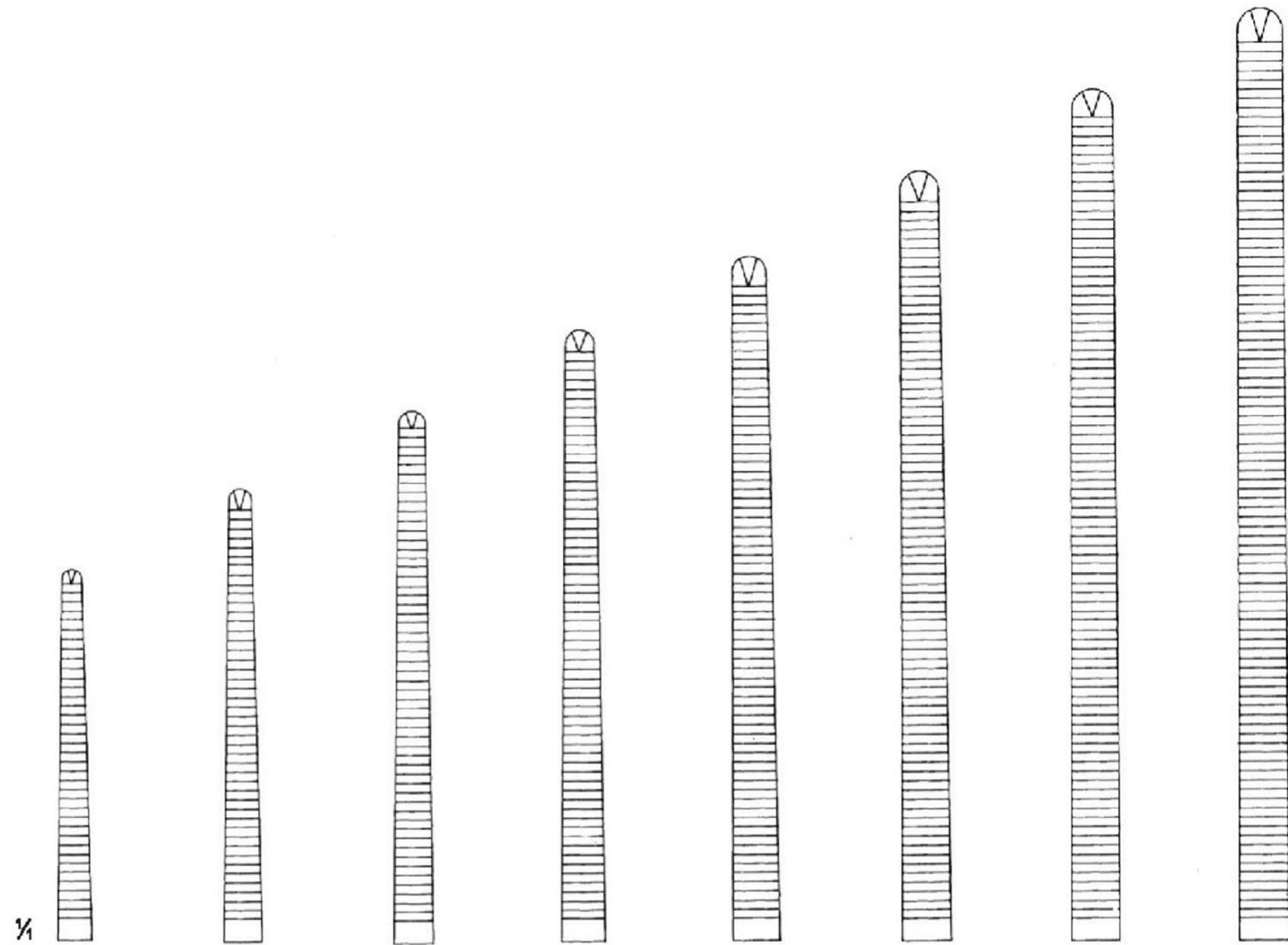

OI 11-2574-16	OI 11-2574-18	OI 11-2574-20	OI 11-2574-22	OI 11-2574-24	OI 11-2574-26	OI 11-2574-28	OI 11-2574-30
16 cm/6 1/4"	18 cm/7 1/8"	20 cm/7 7/8"	22 cm/8 1/2"	24 cm/9 1/2"	26 cm/10 1/4"	28 cm/11"	30 cm/11 3/4"

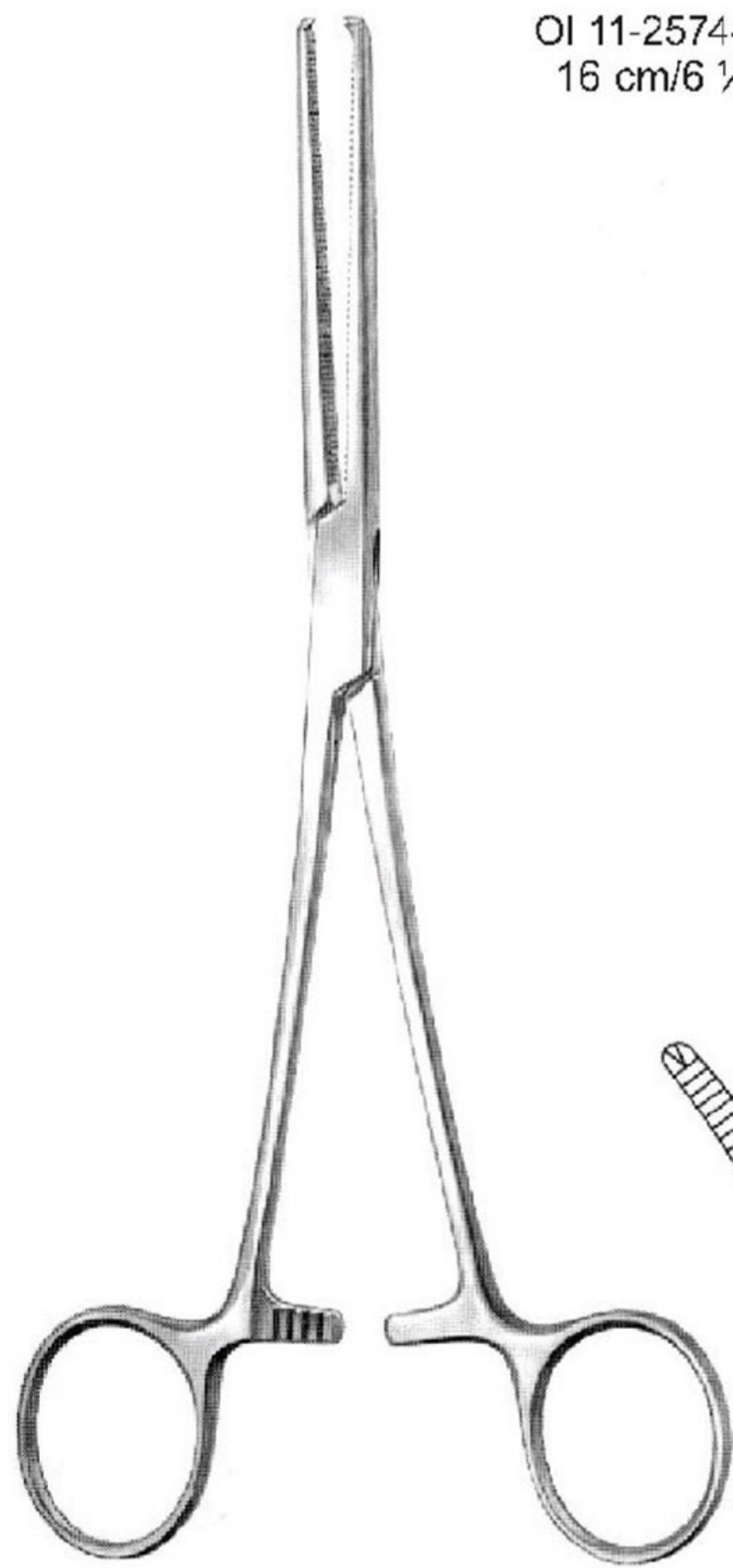

KOCHER OCHSNER
1 : 2

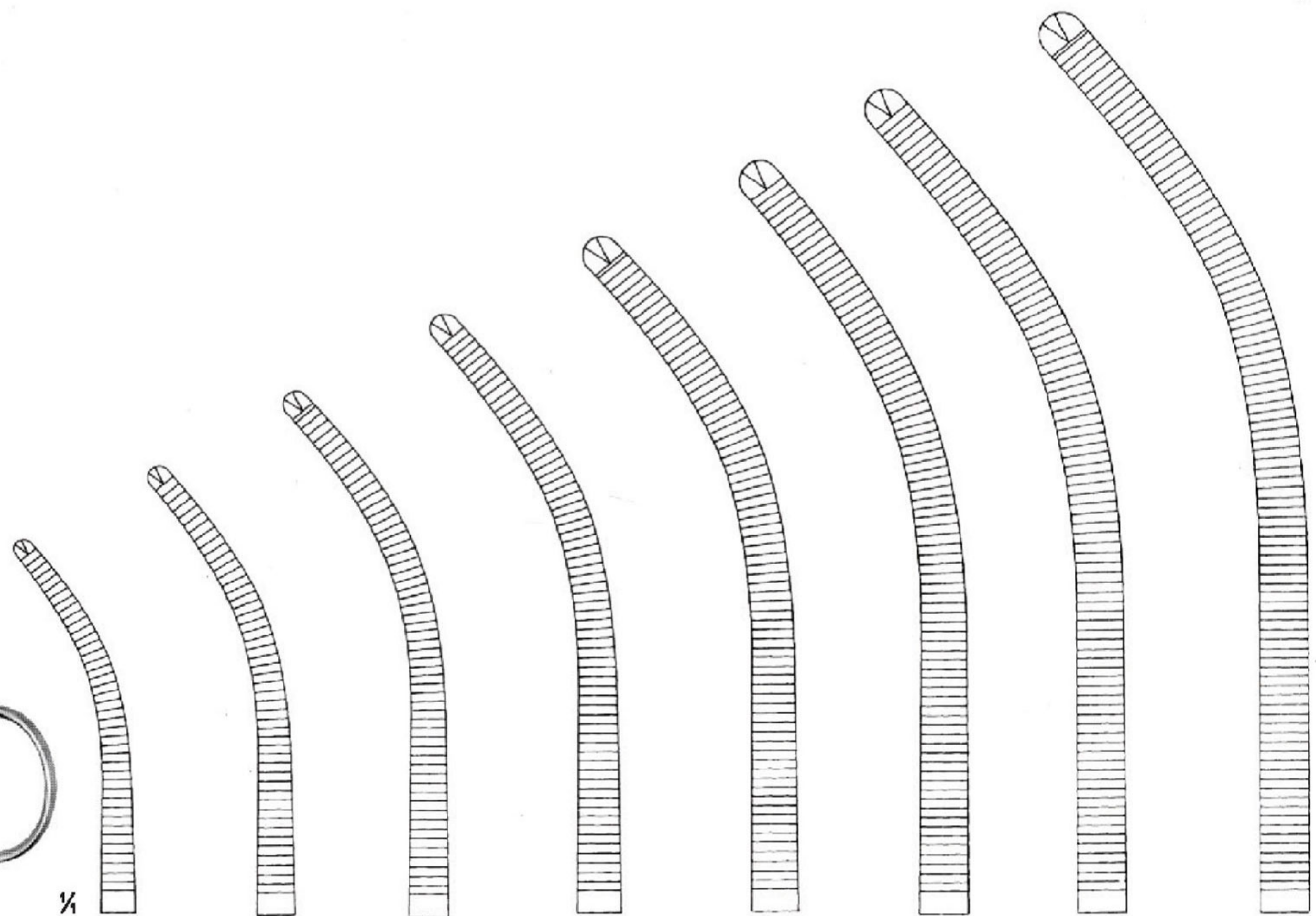

OI 11-2575-16	OI 11-2575-18	OI 11-2575-20	OI 11-2575-22	OI 11-2575-24	OI 11-2575-26	OI 11-2575-28	OI 11-2575-30
16 cm/6 1/4"	18 cm/7 1/8"	20 cm/7 7/8"	22 cm/8 1/2"	24 cm/9 1/2"	26 cm/10 1/4"	28 cm/11"	30 cm/11 3/4"

ARTERY FORCEPS

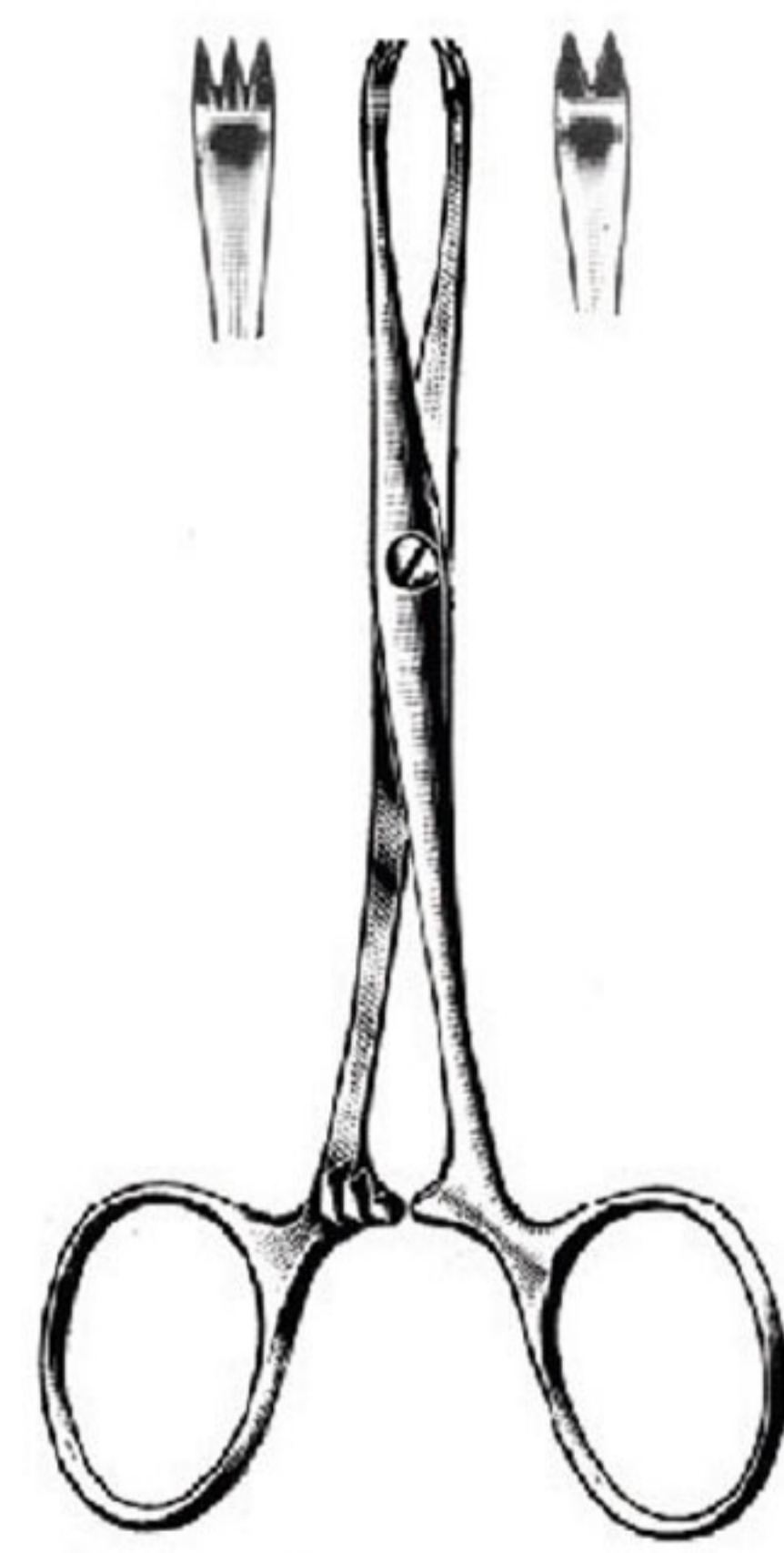

CHAPUT
OI 11-2576-13
13 cm/5 1/8"

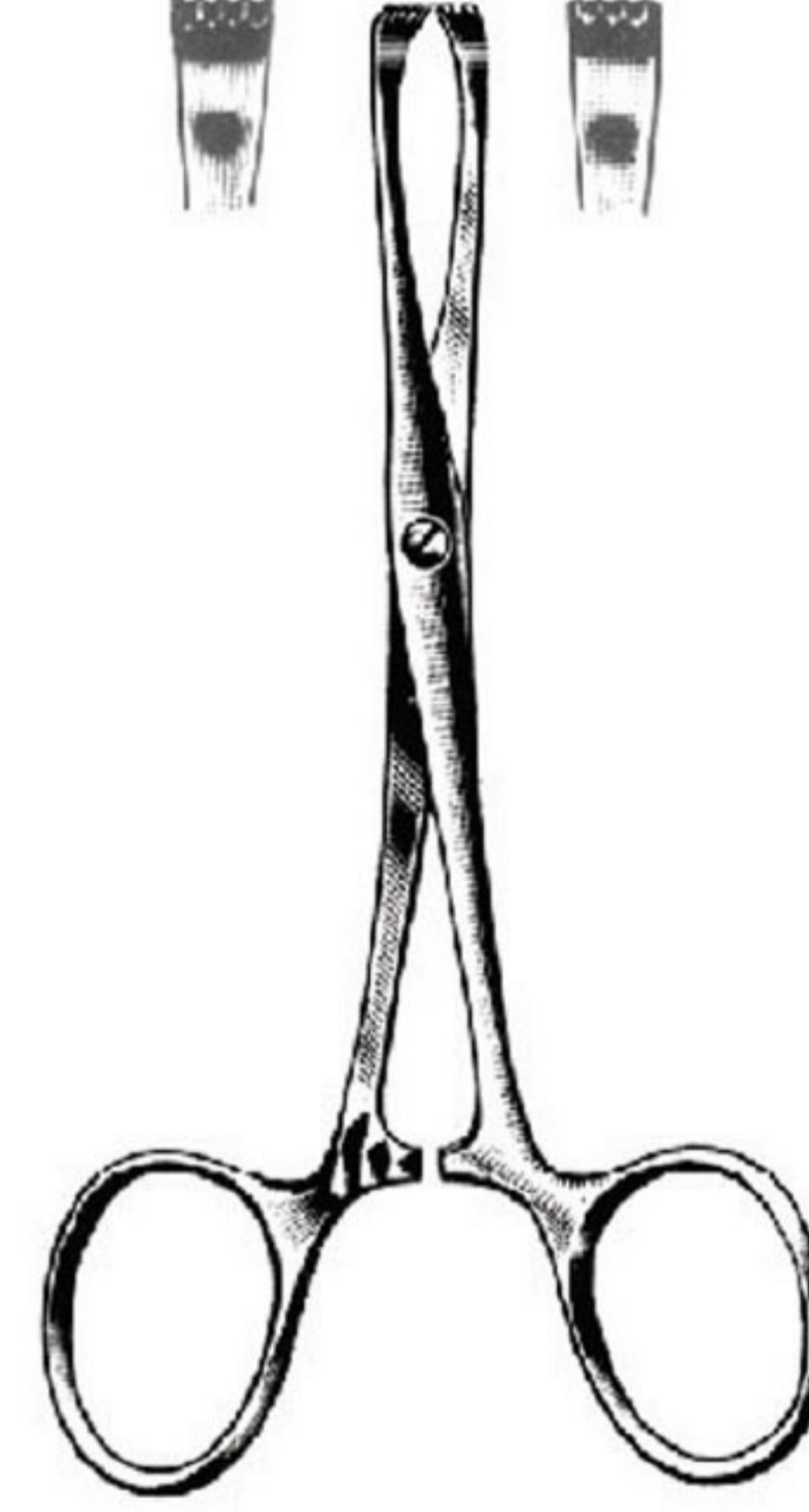

TUFFIER
OI 11-2577-13
13 cm/5 1/8"

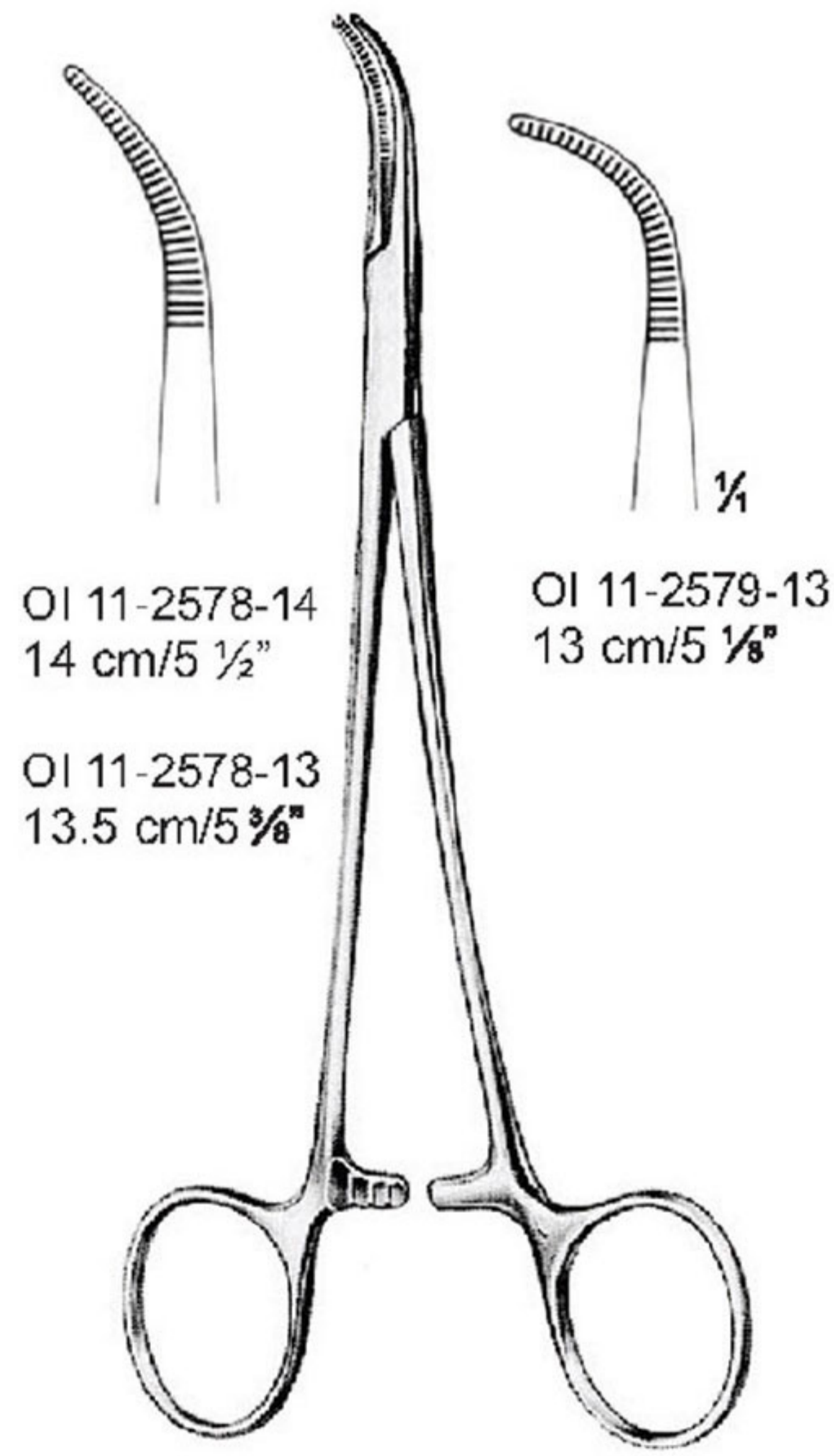

OI 11-2578-14
14 cm/5 1/2"
OI 11-2578-13
13.5 cm/5 3/8"

OI 11-2579-13
13 cm/5 1/8"

BABY-MIXTER

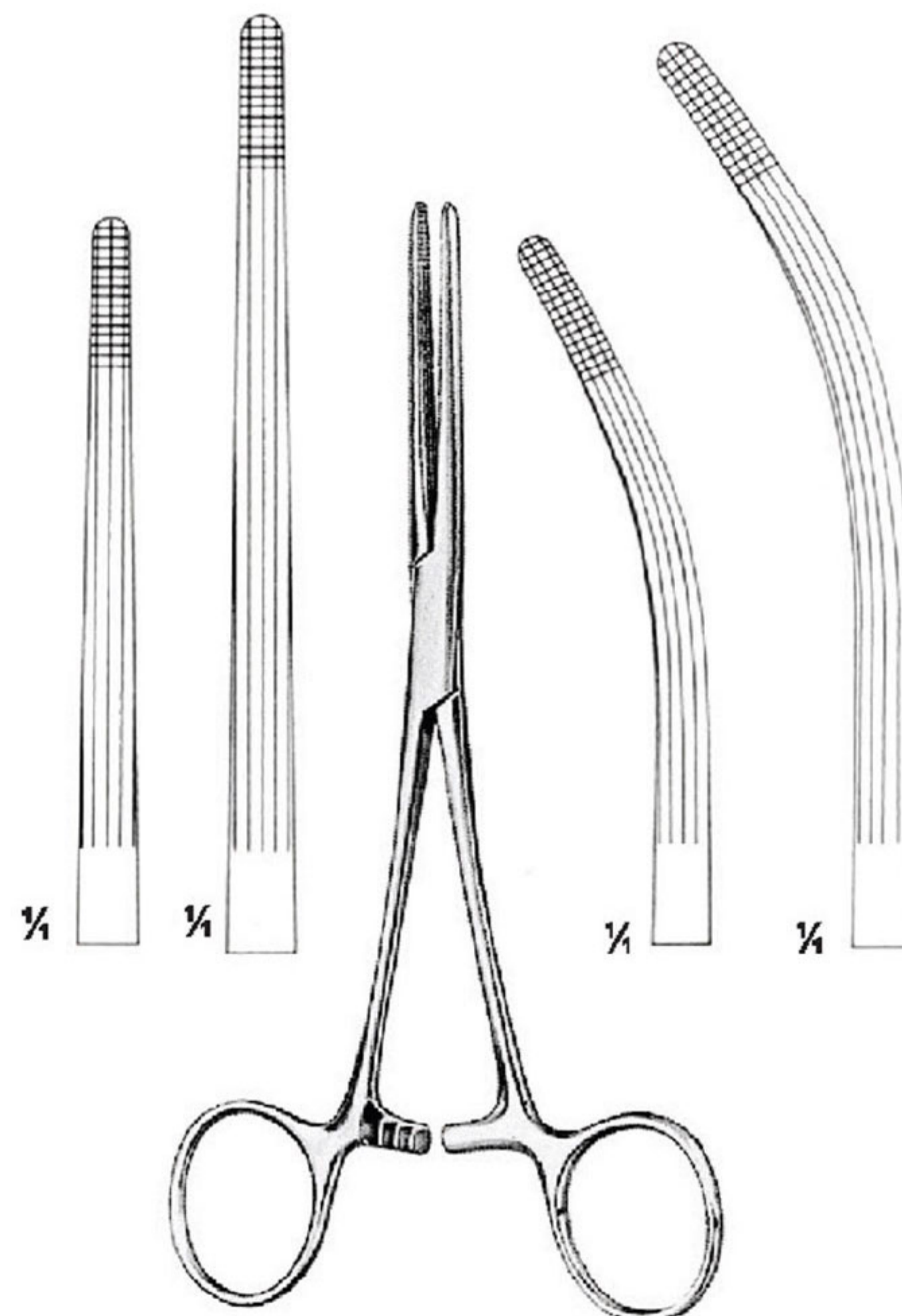

ROCHESTER-CARMALT
OI 11-2580-16 16 cm/6 1/4" OI 11-2581-16
OI 11-2580-20 20 cm/7 7/8" OI 11-2581-20

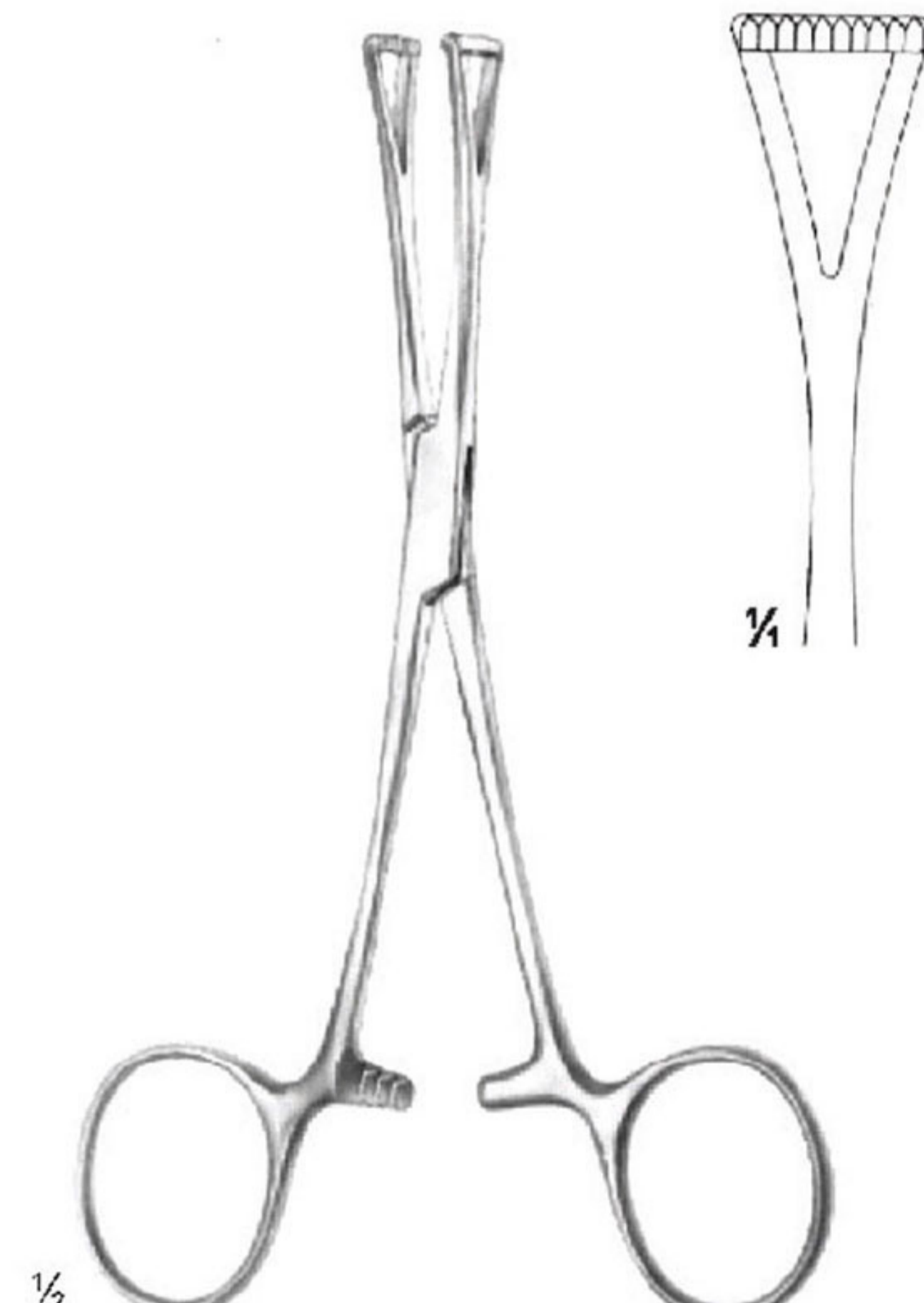

COLLIN
OI 11-2582-14
14 cm/5 1/2"

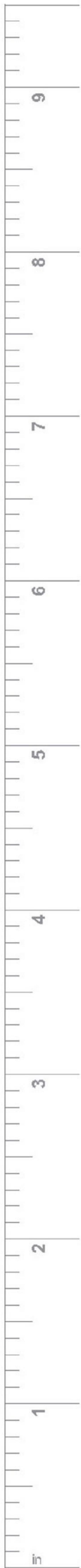



BIRKET
18.5 cm/7 1/4"

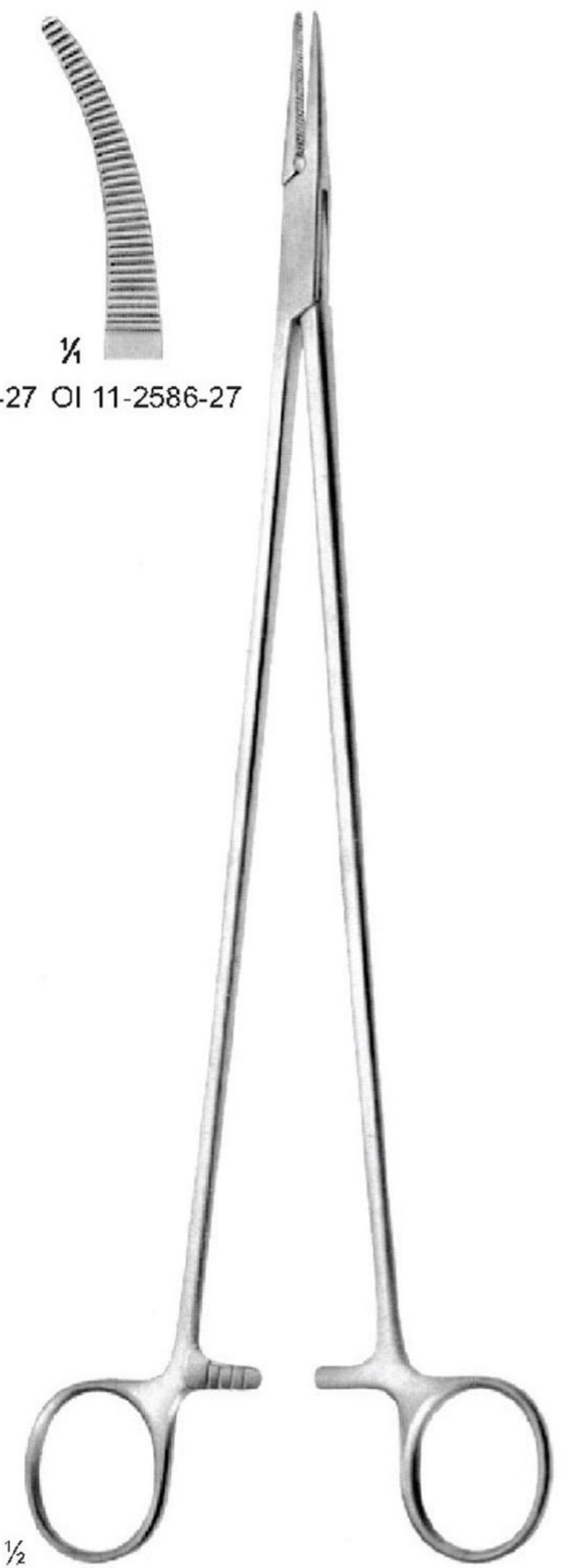
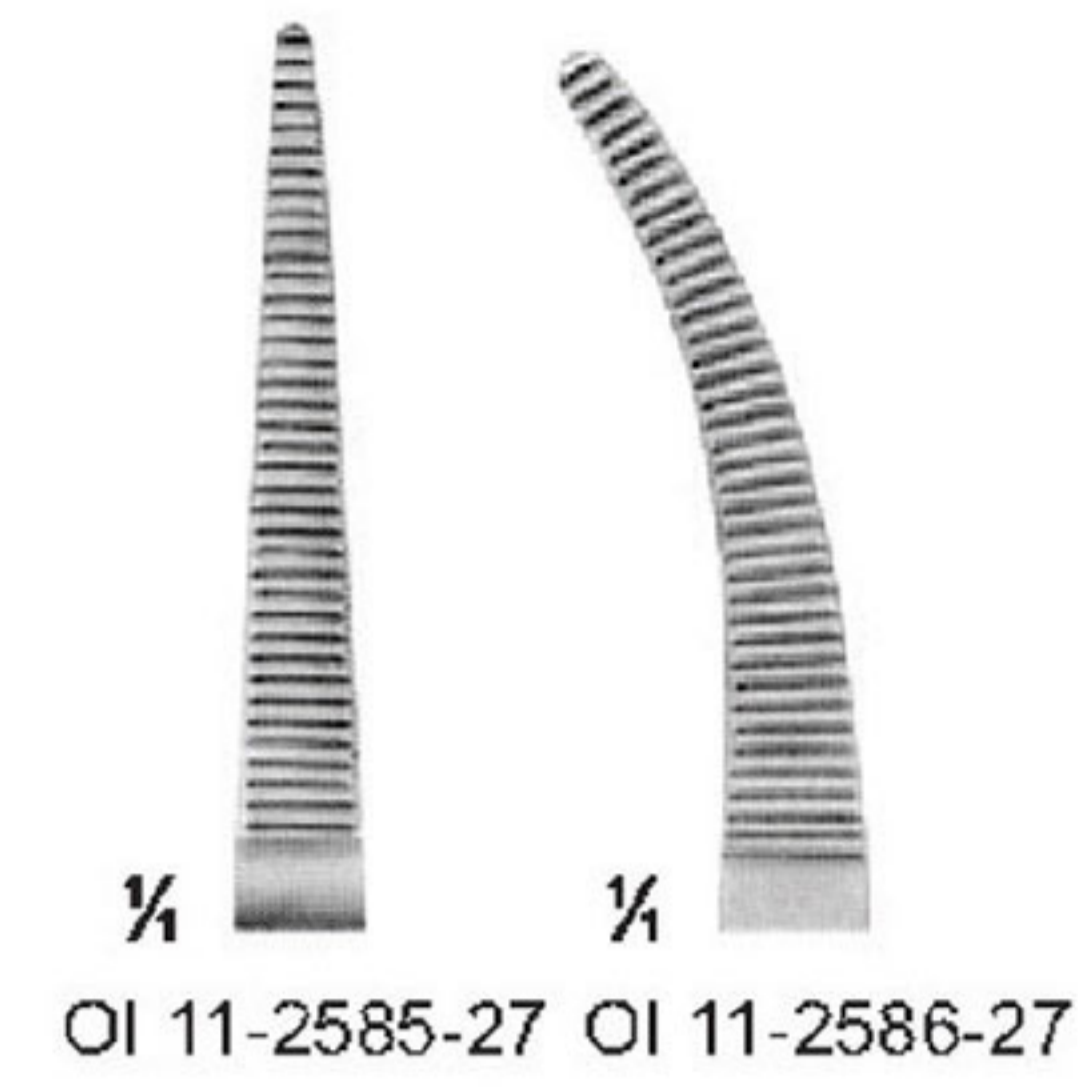
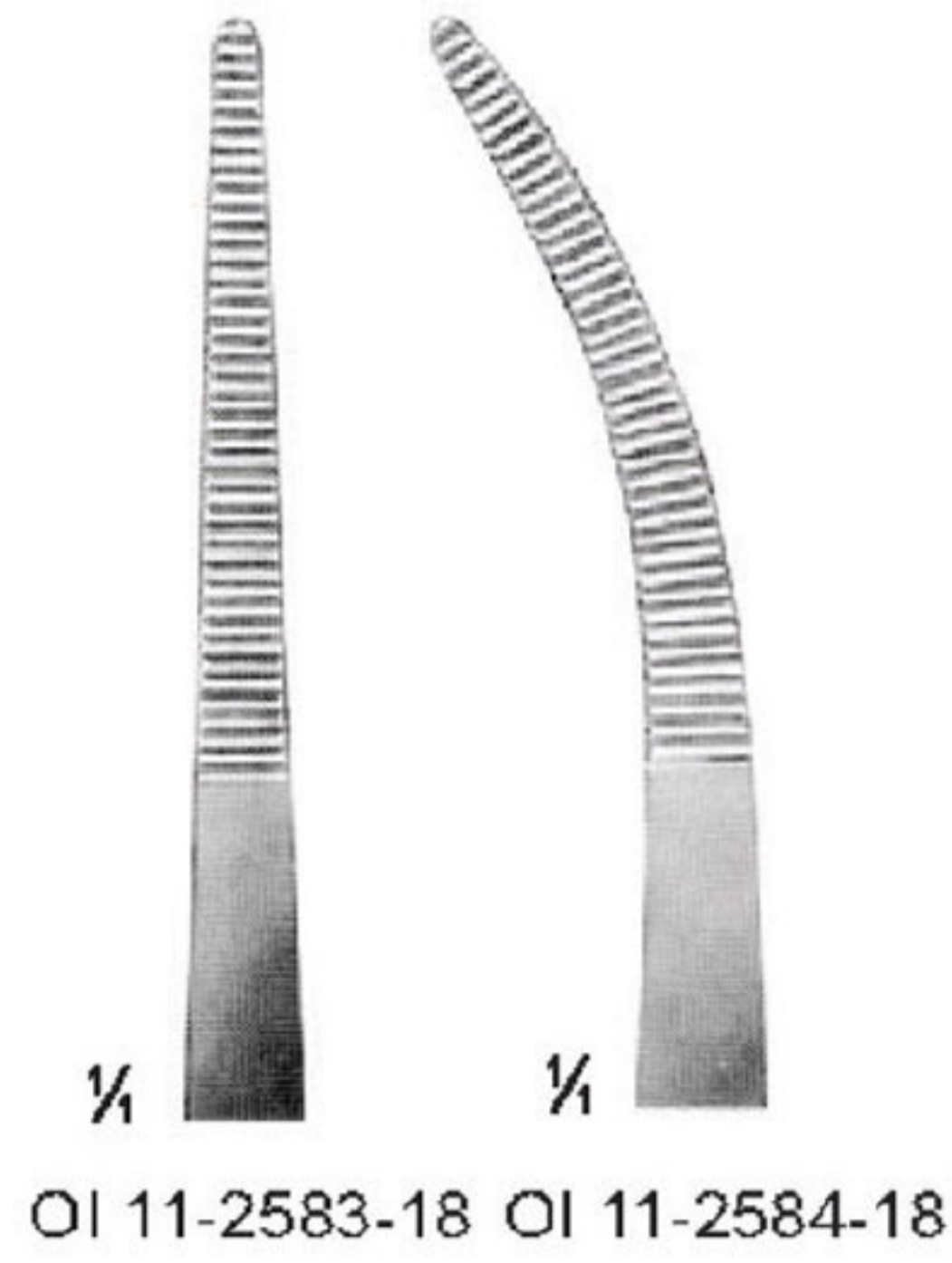

BRIDGE
27.5 cm/10 3/4"



BENGOLEA

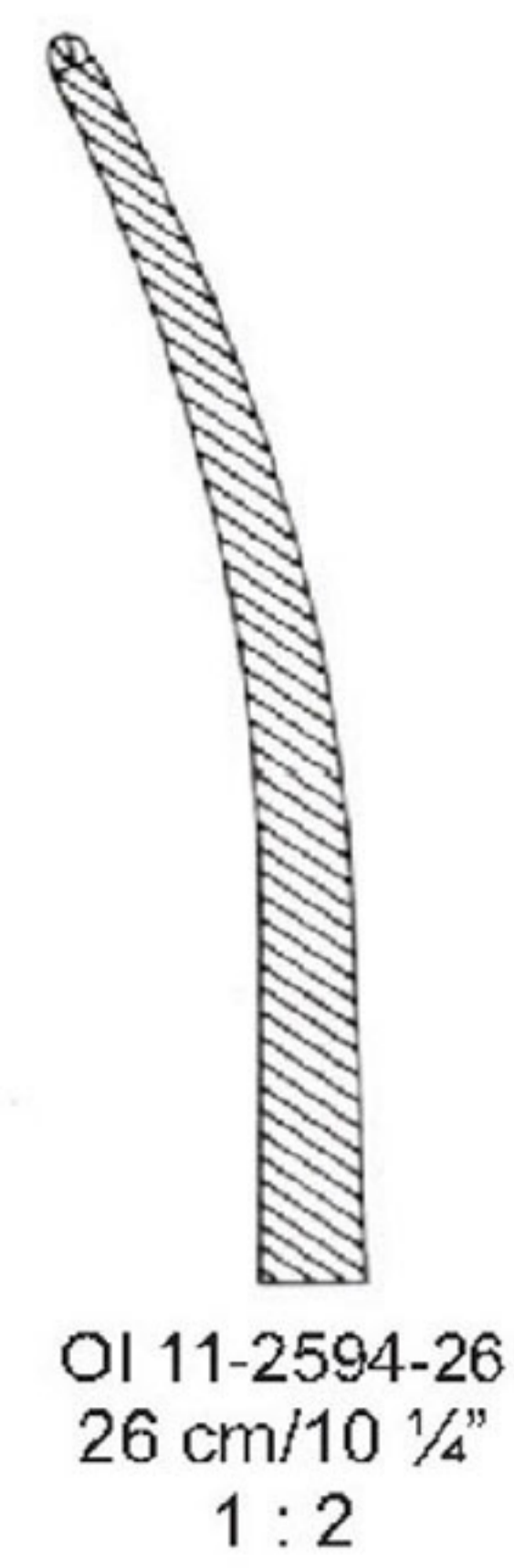
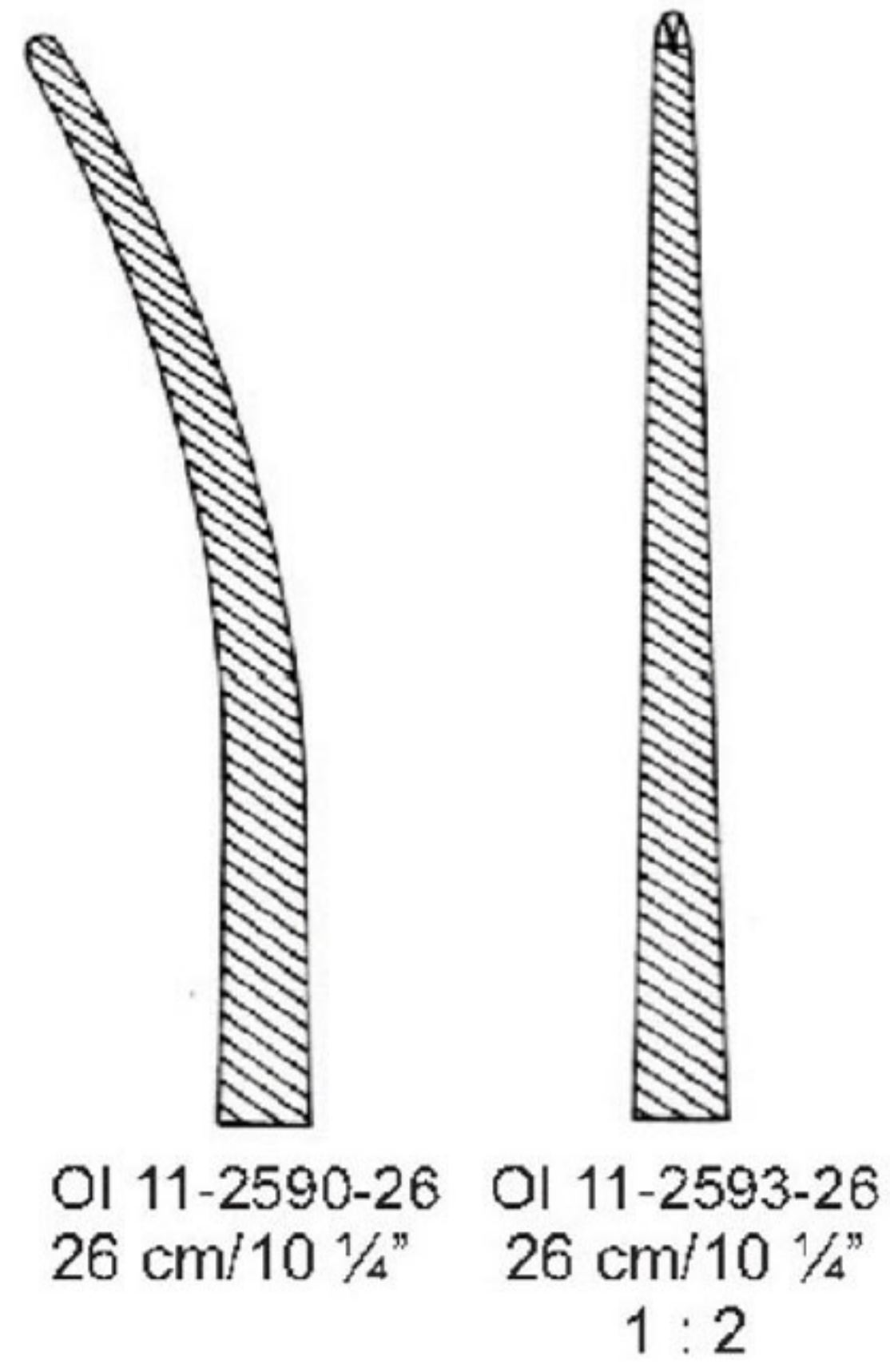
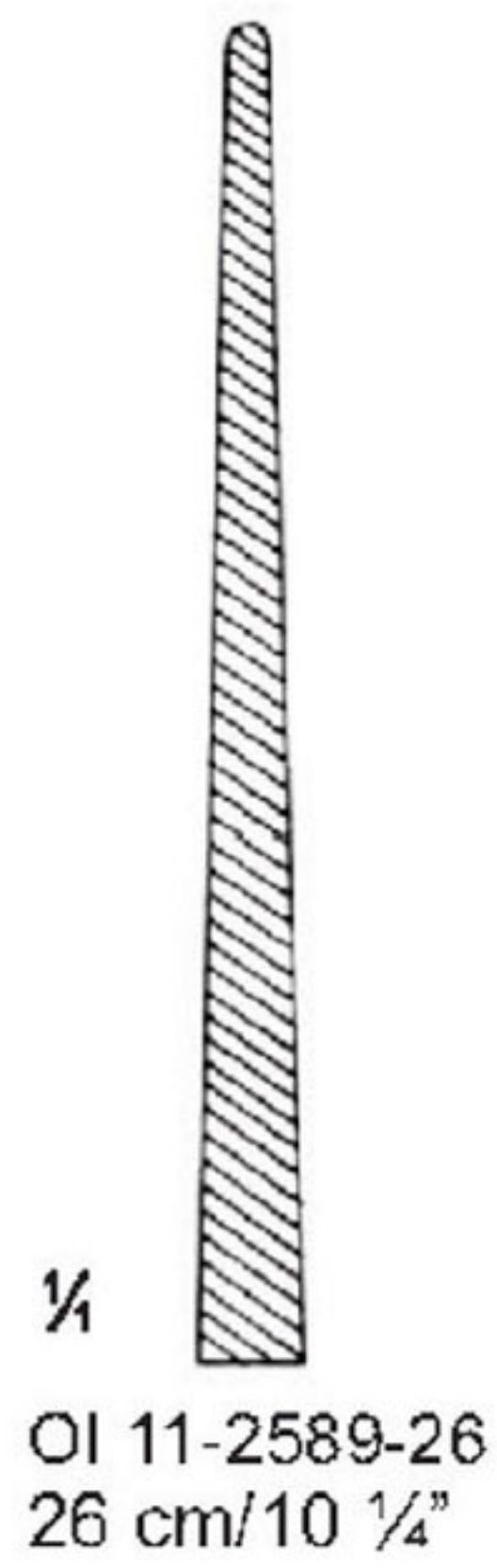
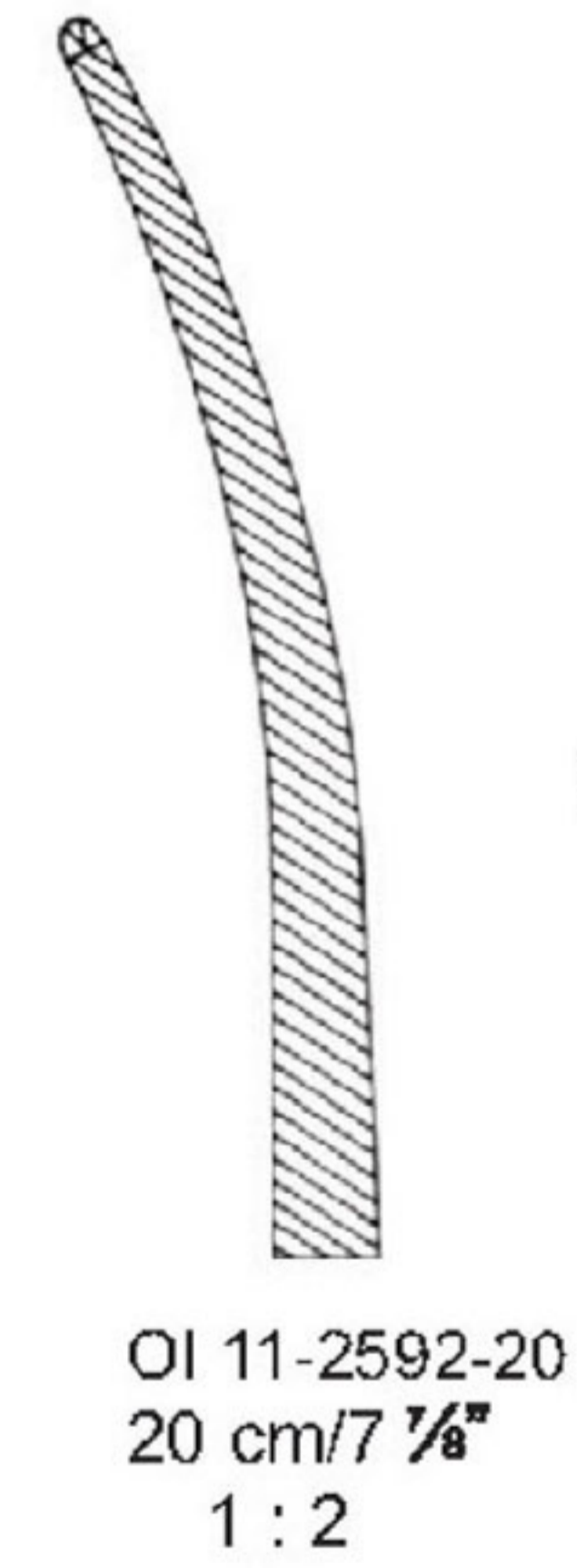
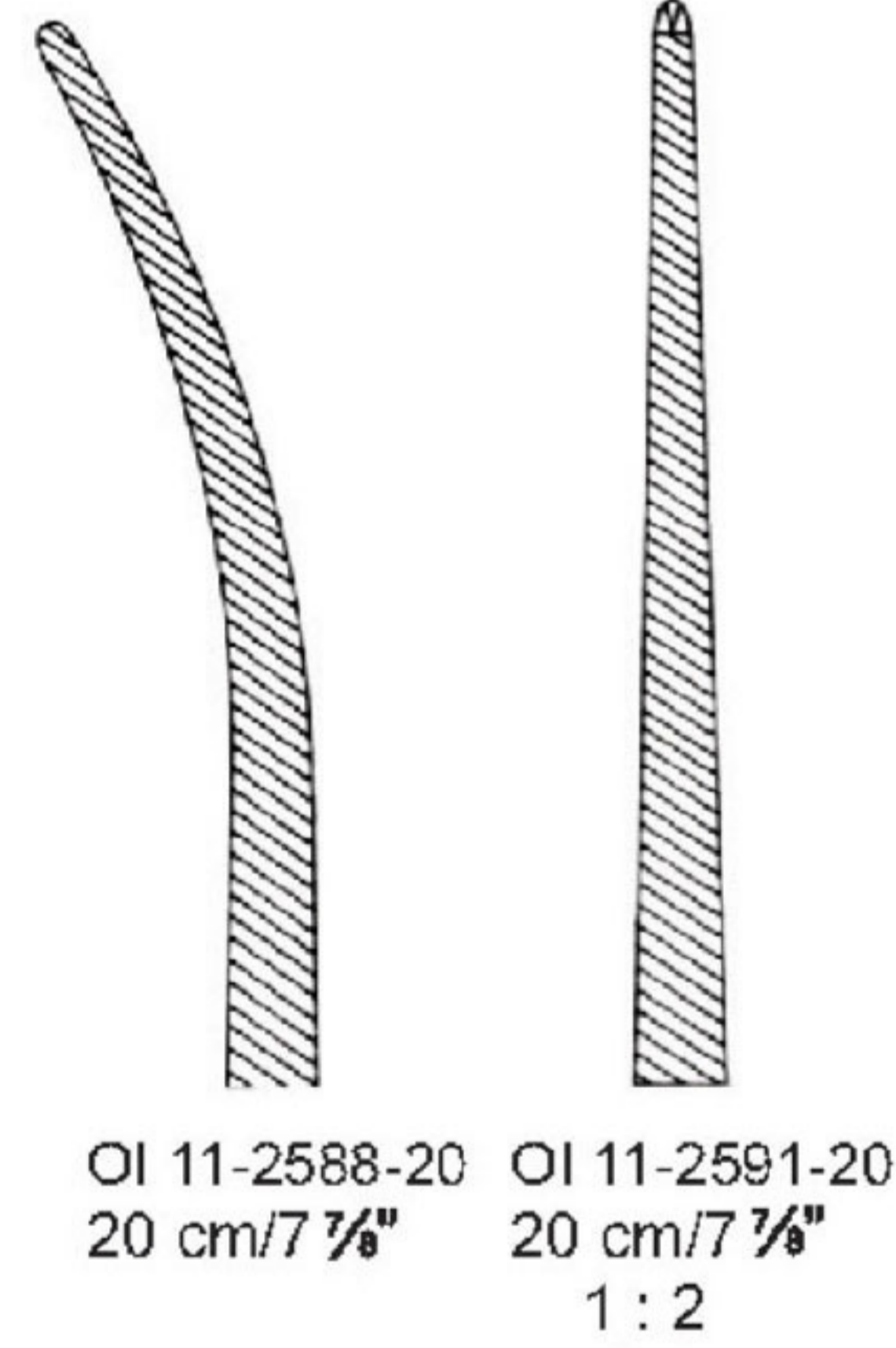
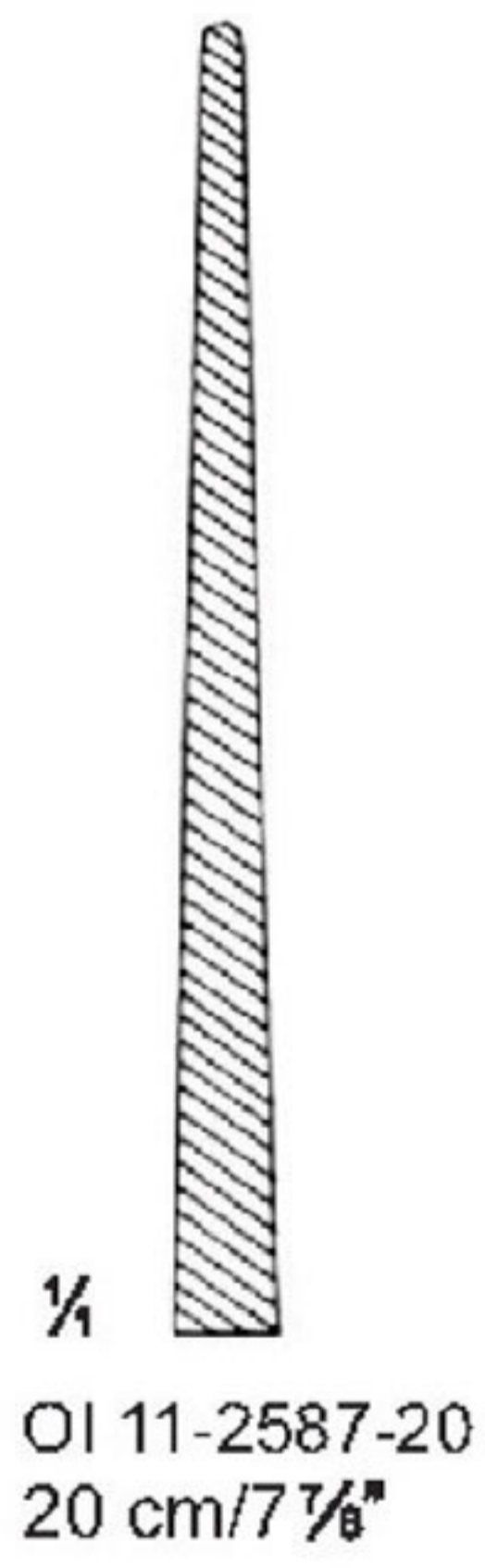

ARTERY FORCEPS



PENNINGTON
 OI 11-2595-15 15.5 cm/6 1/8"
 OI 11-2595-20 20 cm/7 7/8"

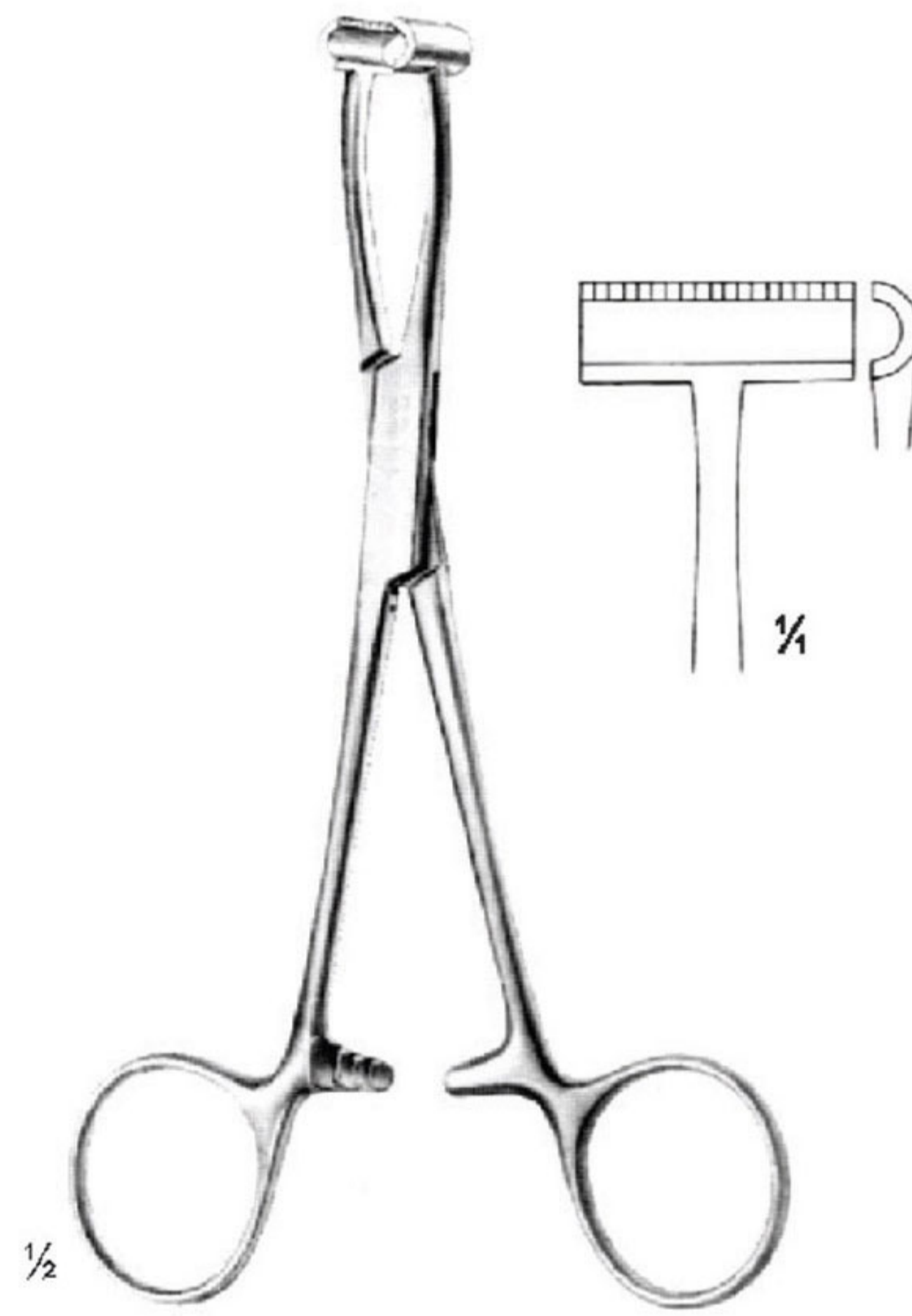

PRATT
 OI 11-2596-15
 15 cm/5 7/8"

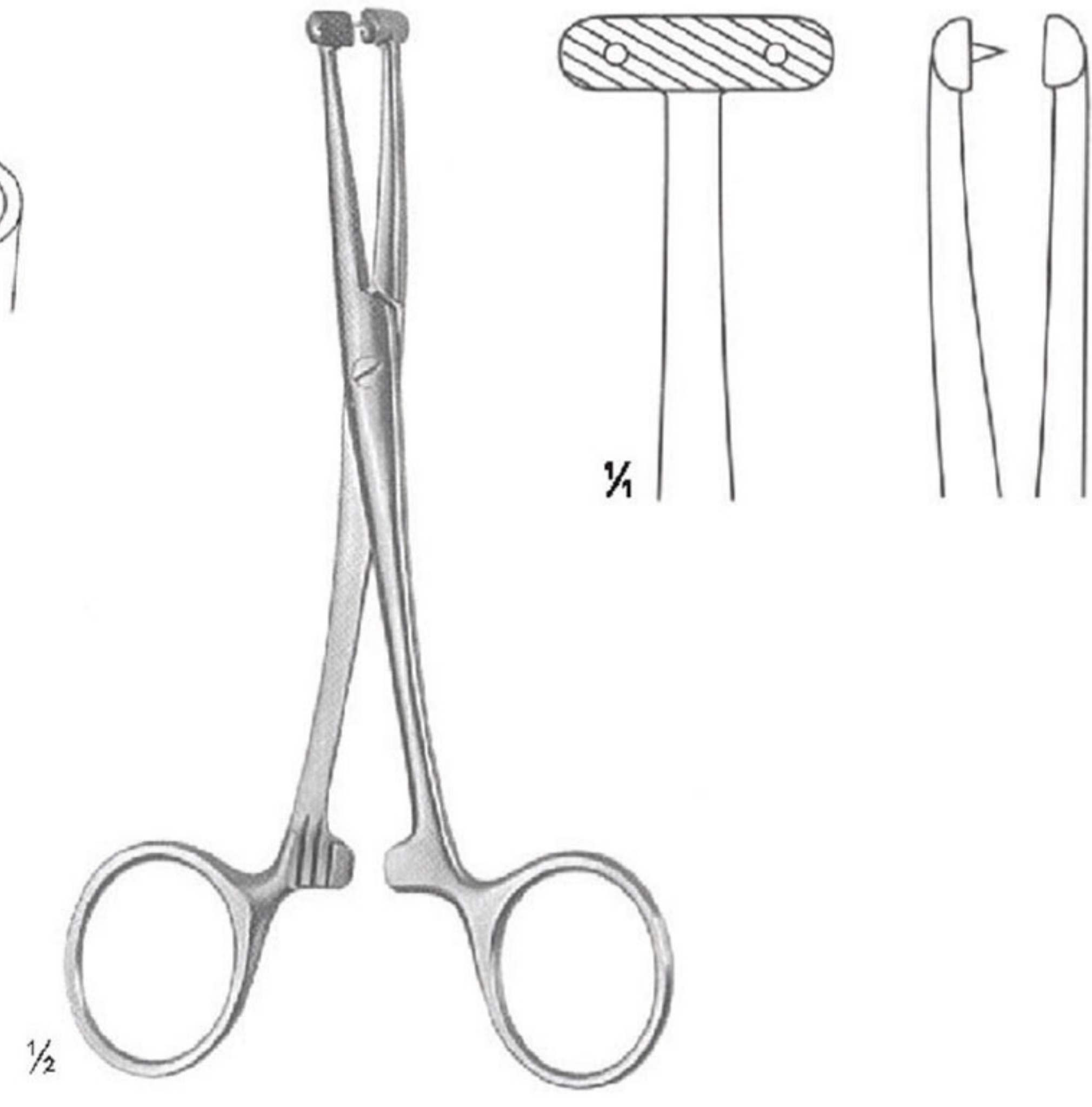

MARTEL
 OI 11-2597-14
 14 cm/5 1/2"



WILLET-MARTEL
 OI 11-2598-19
 19 cm/7 1/2"

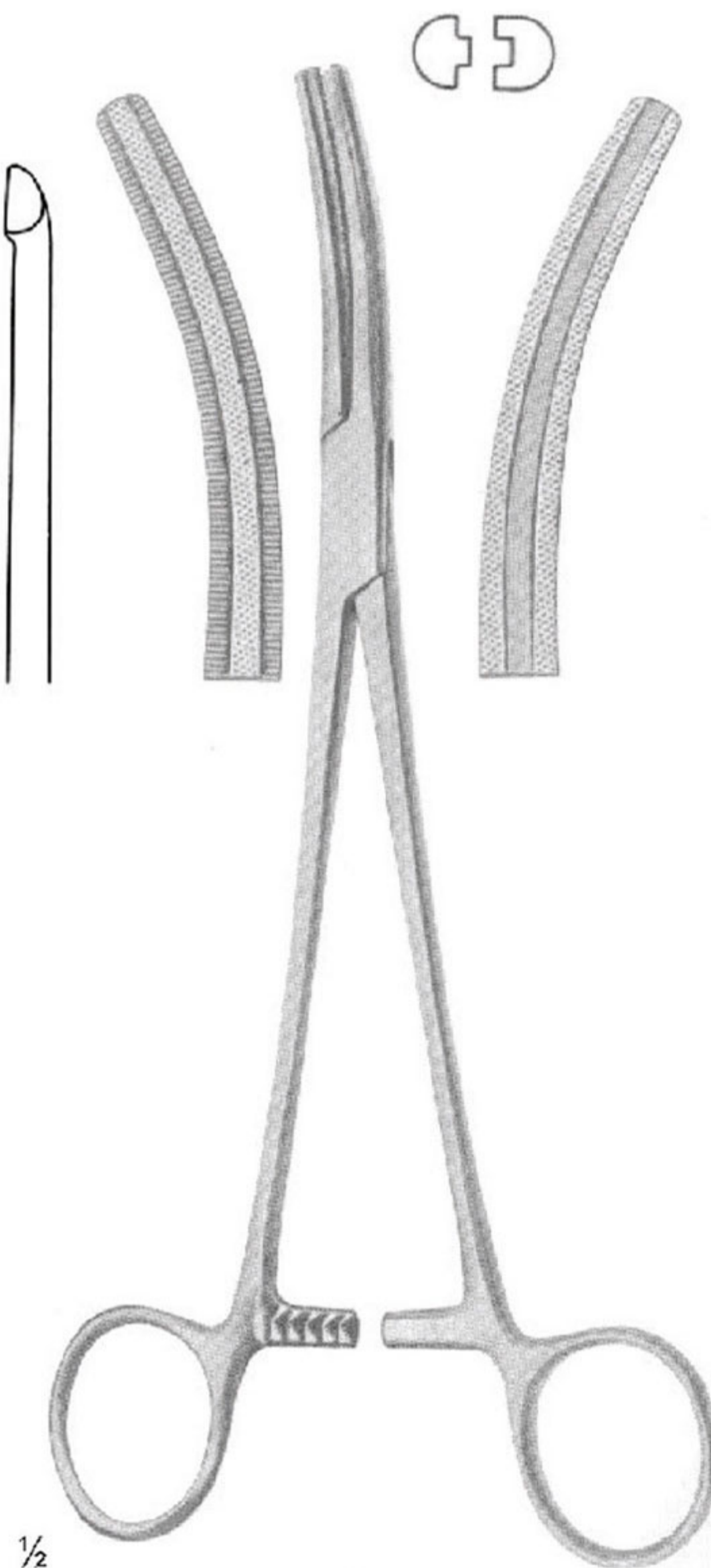

BUIE
 OI 11-2599-21
 21 cm/8 1/4"

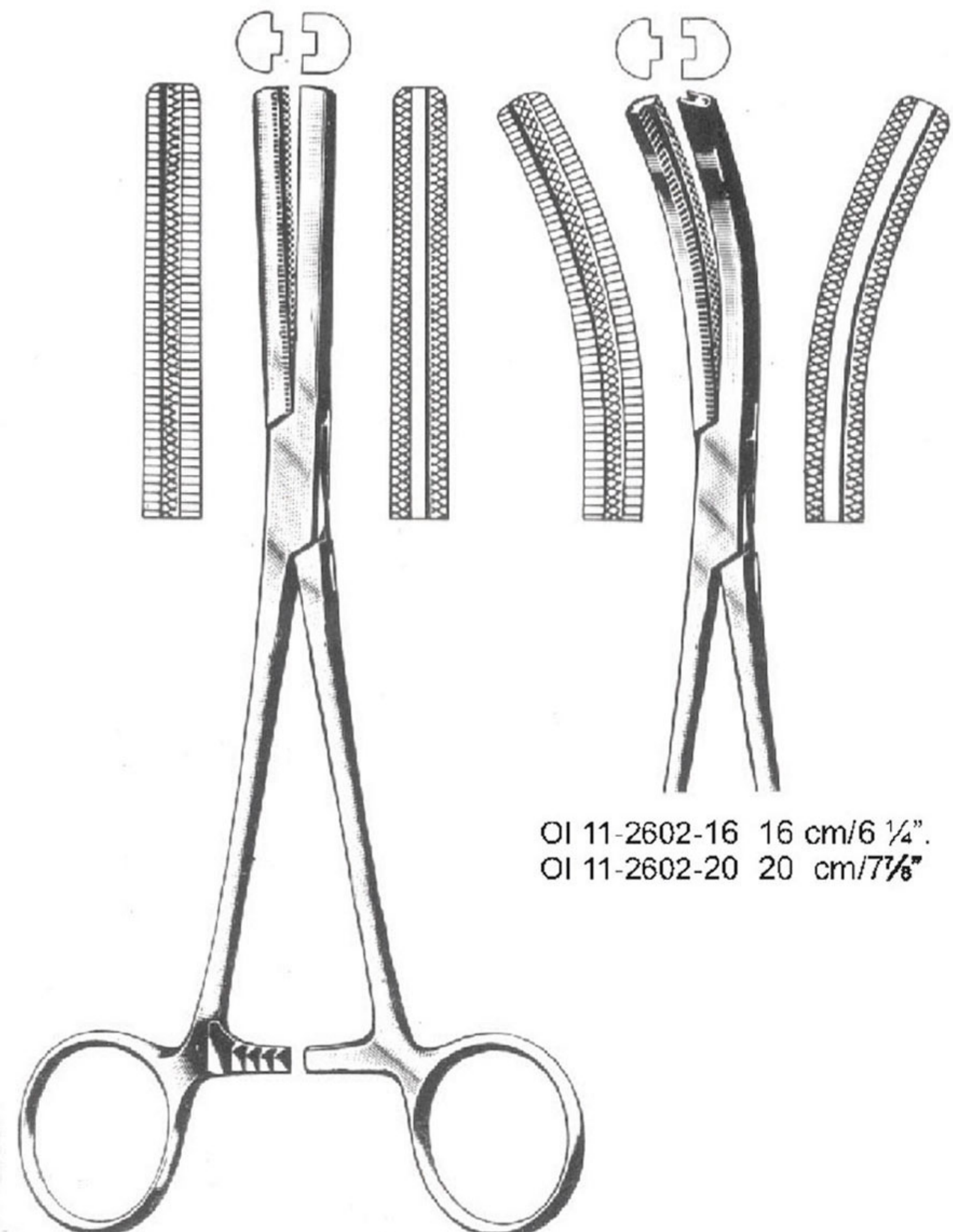

FERGUSSON
 OI 11-2600-16 16 cm/6 1/4"
 OI 11-2600-20 20 cm/7 7/8"

OI 11-2602-16 16 cm/6 1/4"
 OI 11-2602-20 20 cm/7 7/8"



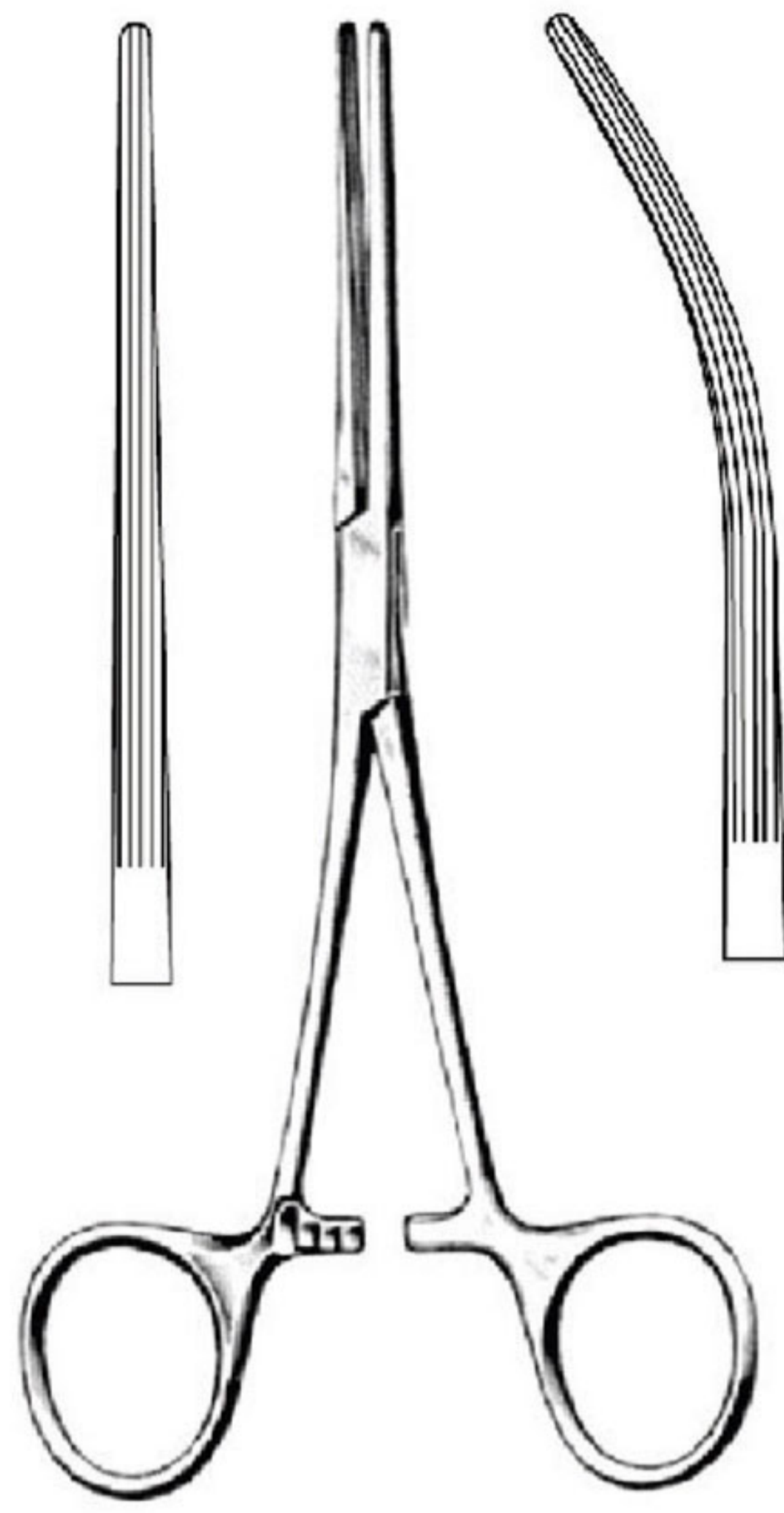

BAINBRIDGE

OI 11-2603-15 15 cm/5 7/8" OI 11-2604-15
OI 11-2603-18 18.5 cm/7 1/4" OI 11-2604-18

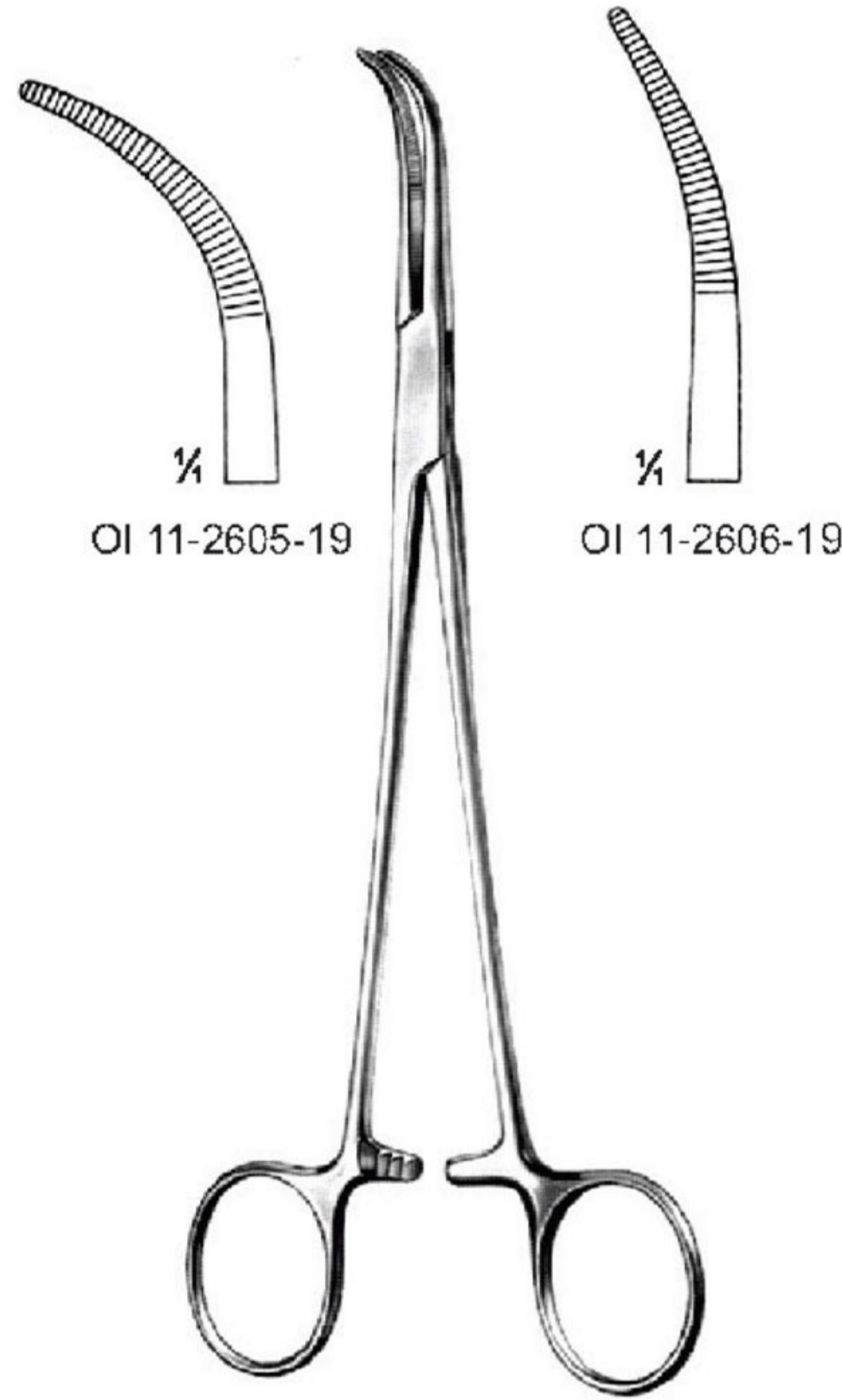

SCHNIDT

19 cm/7 1/2"

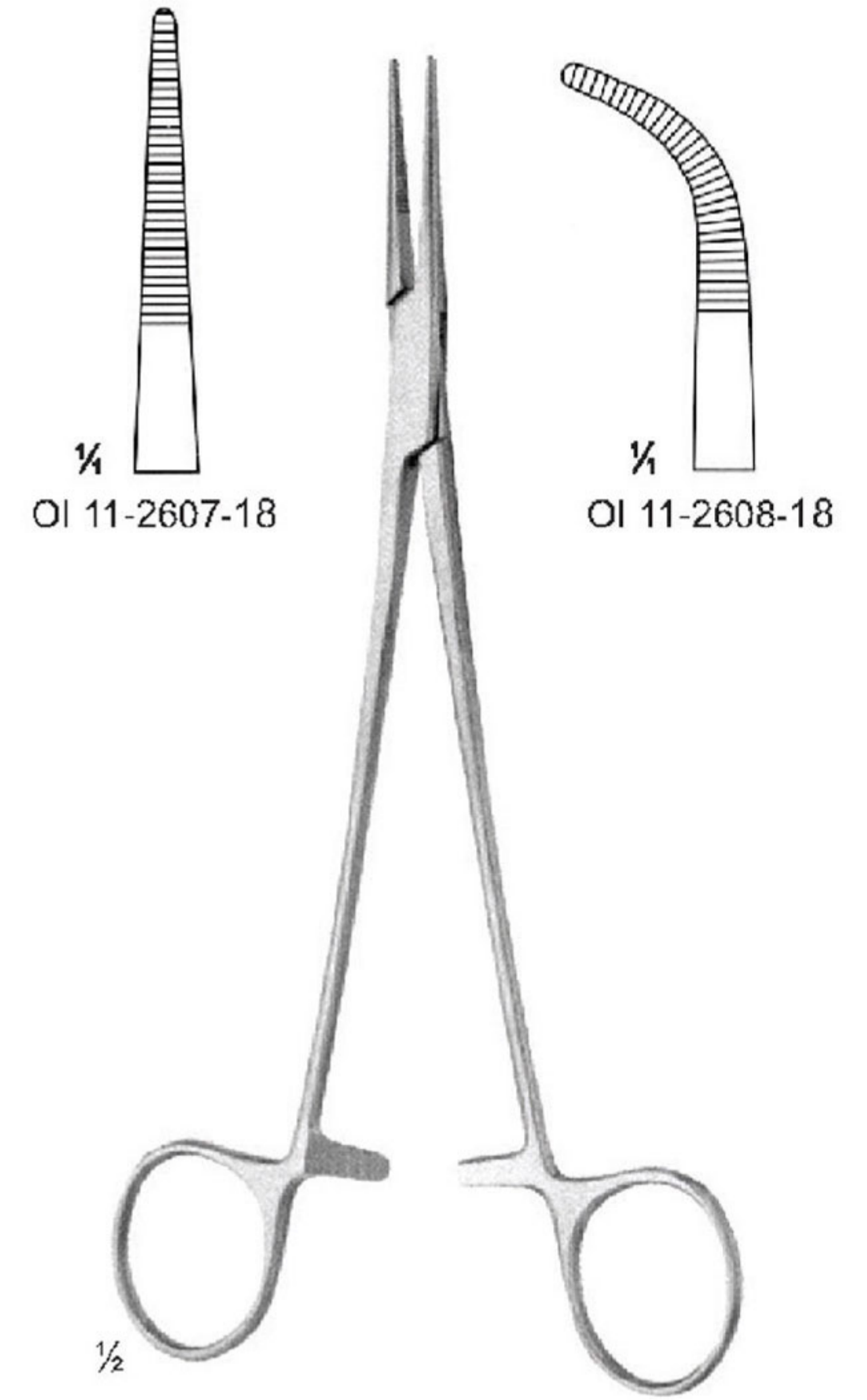

ADSON

18.5 cm/7 1/4"

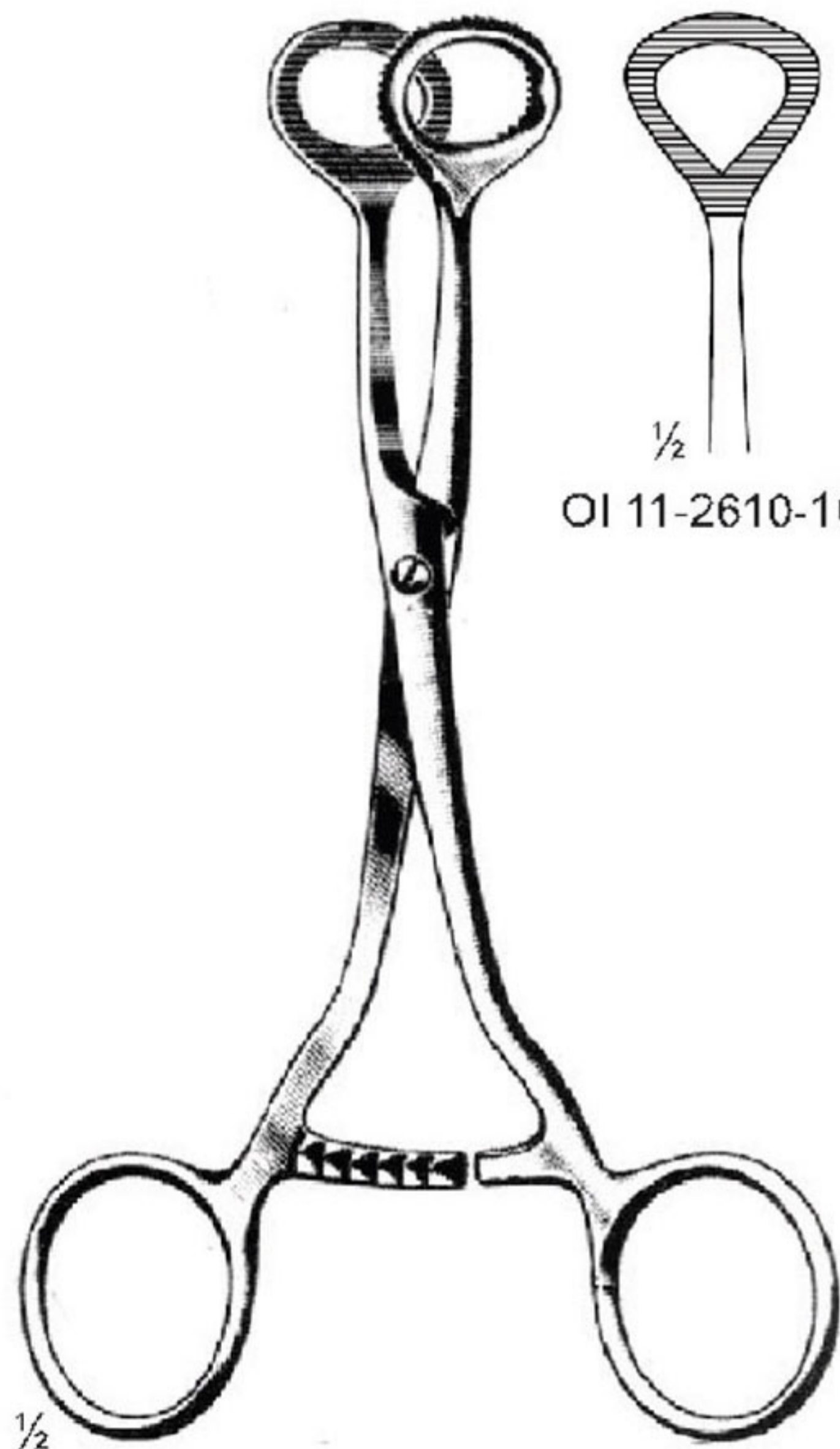

COLLIN

OI 11-2609-16
16 cm/6 1/4"

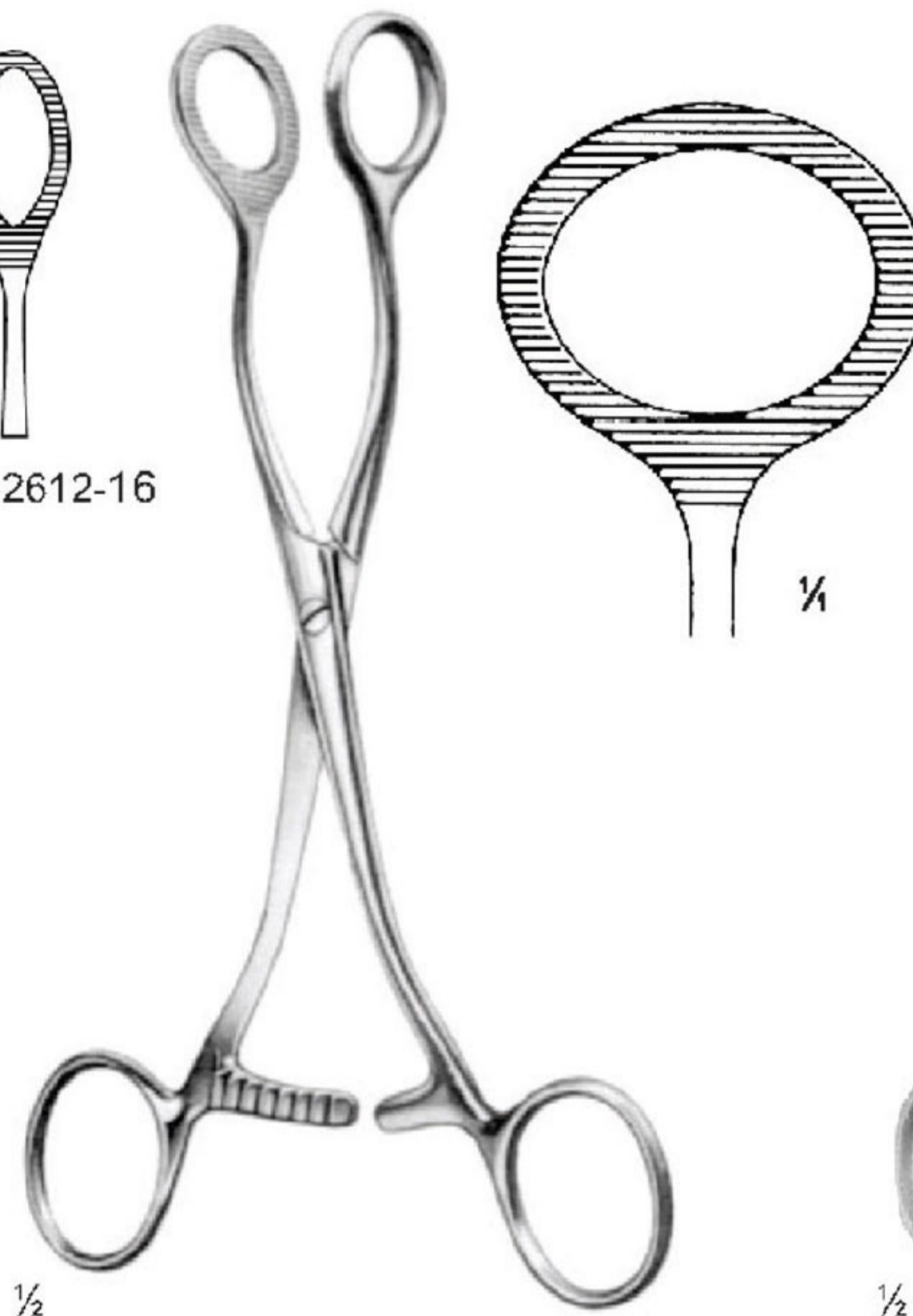

COLLIN

OI 11 2613-16
16.5 cm/6 1/2"

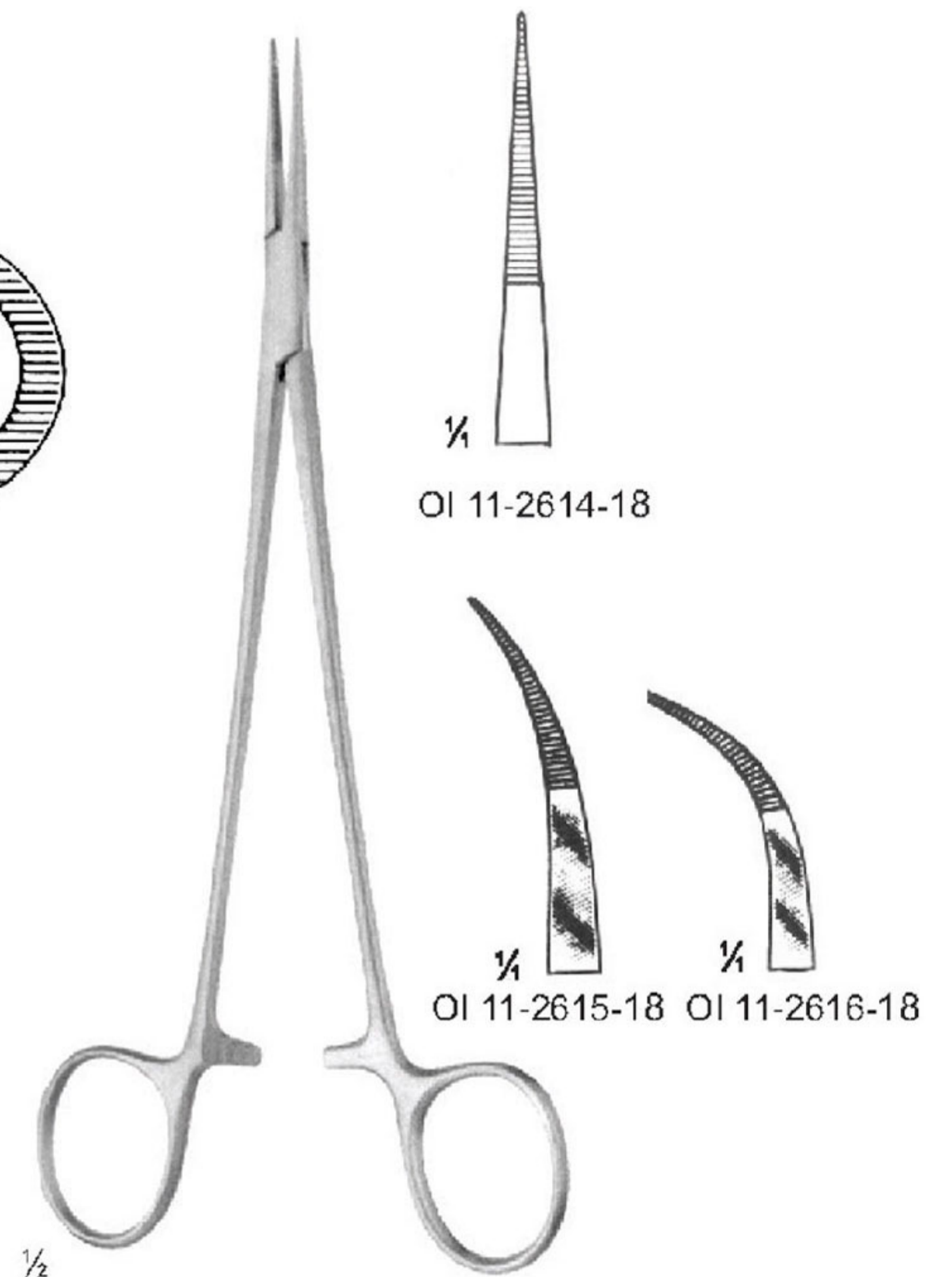

JACOBSON-MICRO

18 cm/7 1/8"

ARTERY FORCEPS

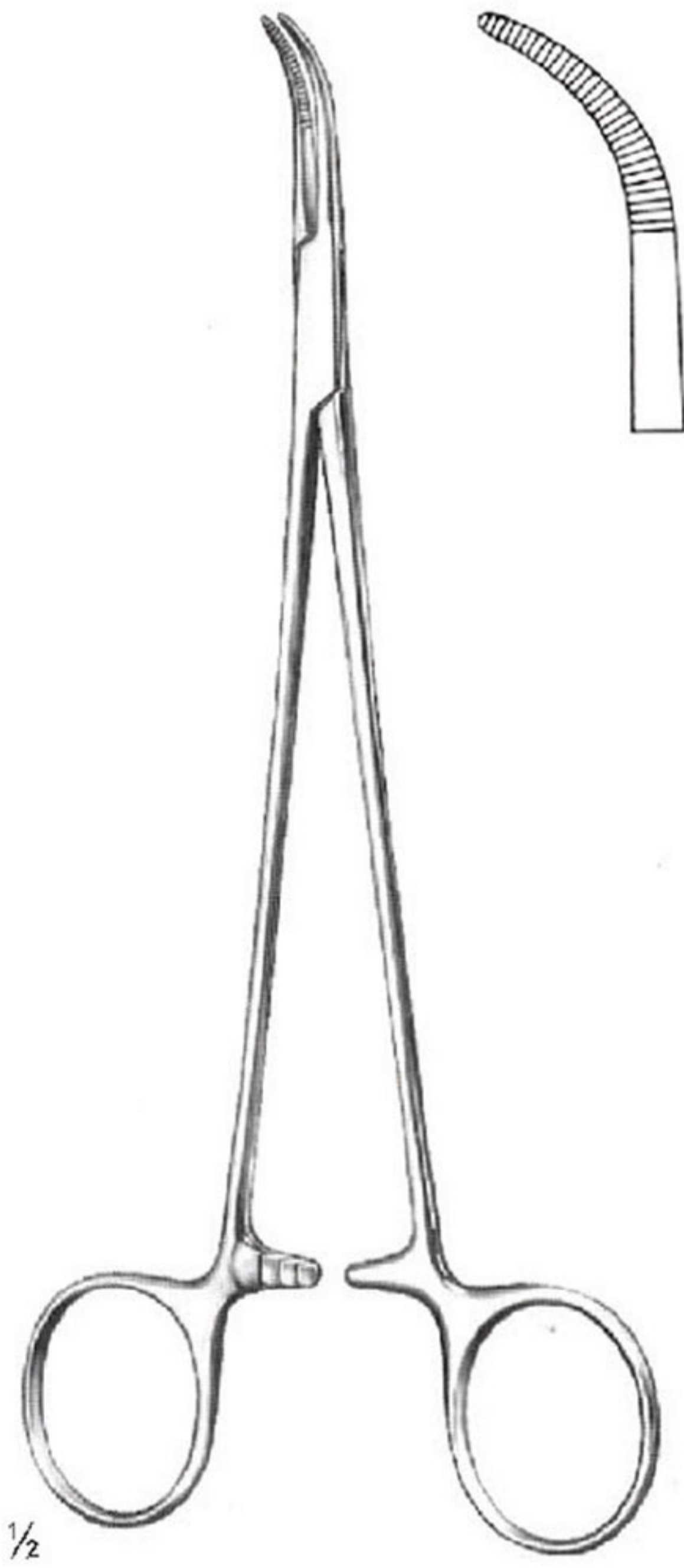

BABY-MIXTER
OI 11-2617-18
18 cm/7 1/8"



MICRO-ADSON
OI 11-2618-14
14 cm/5 1/2"

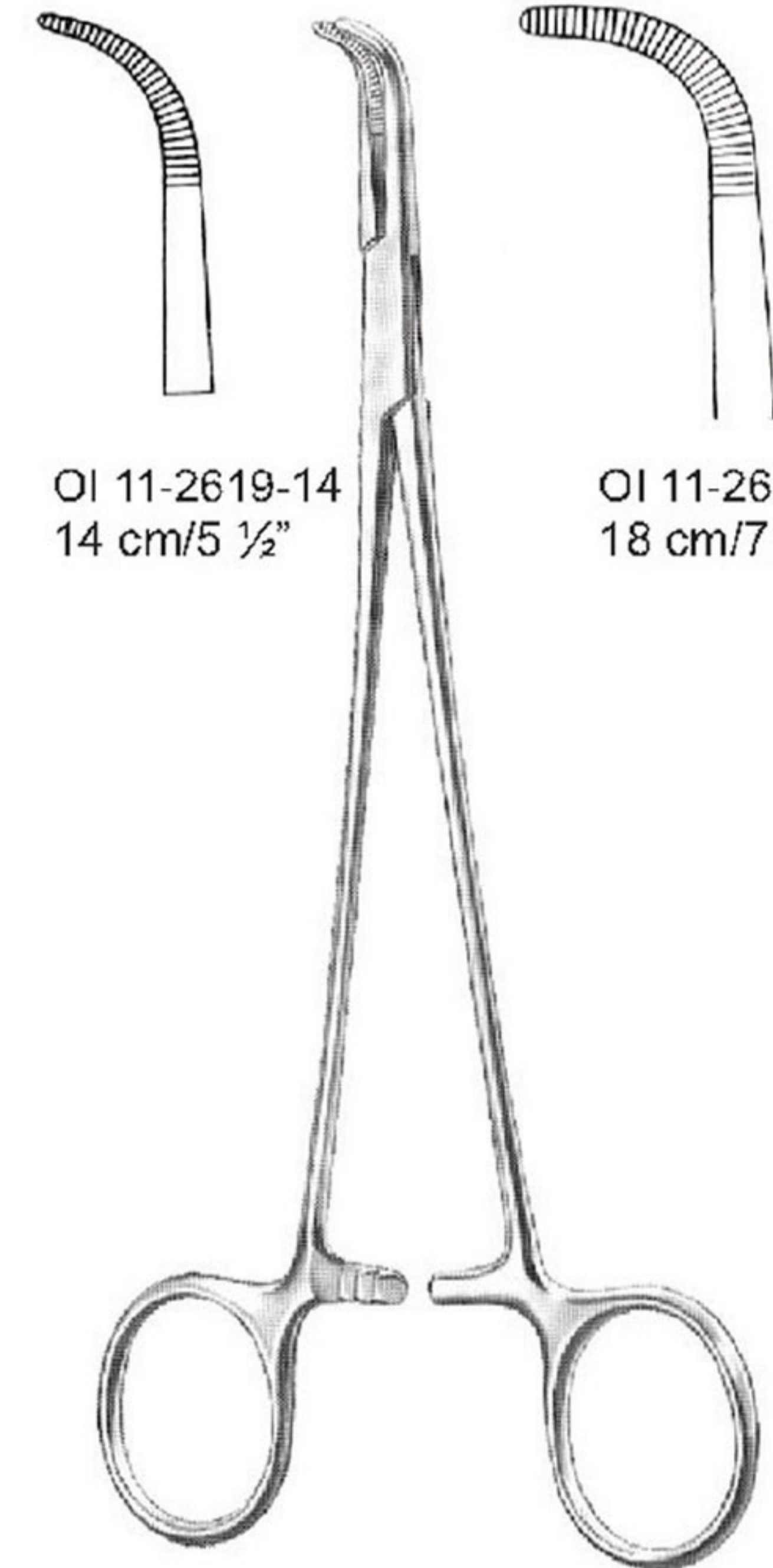

OI 11-2619-14
14 cm/5 1/2"

OI 11-2619-18
18 cm/7 1/8"

ADSON-BABY

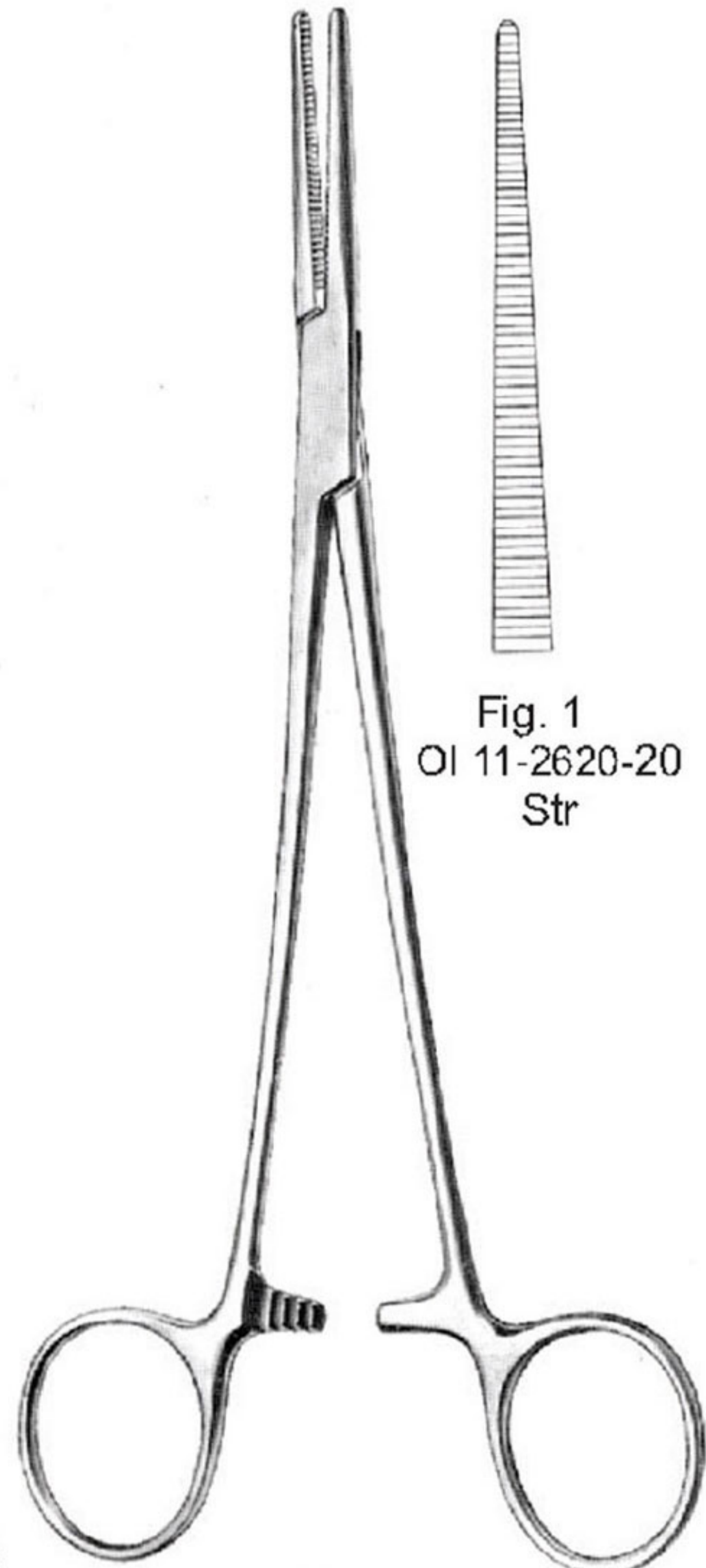

HEISS
20 cm/7 7/8"

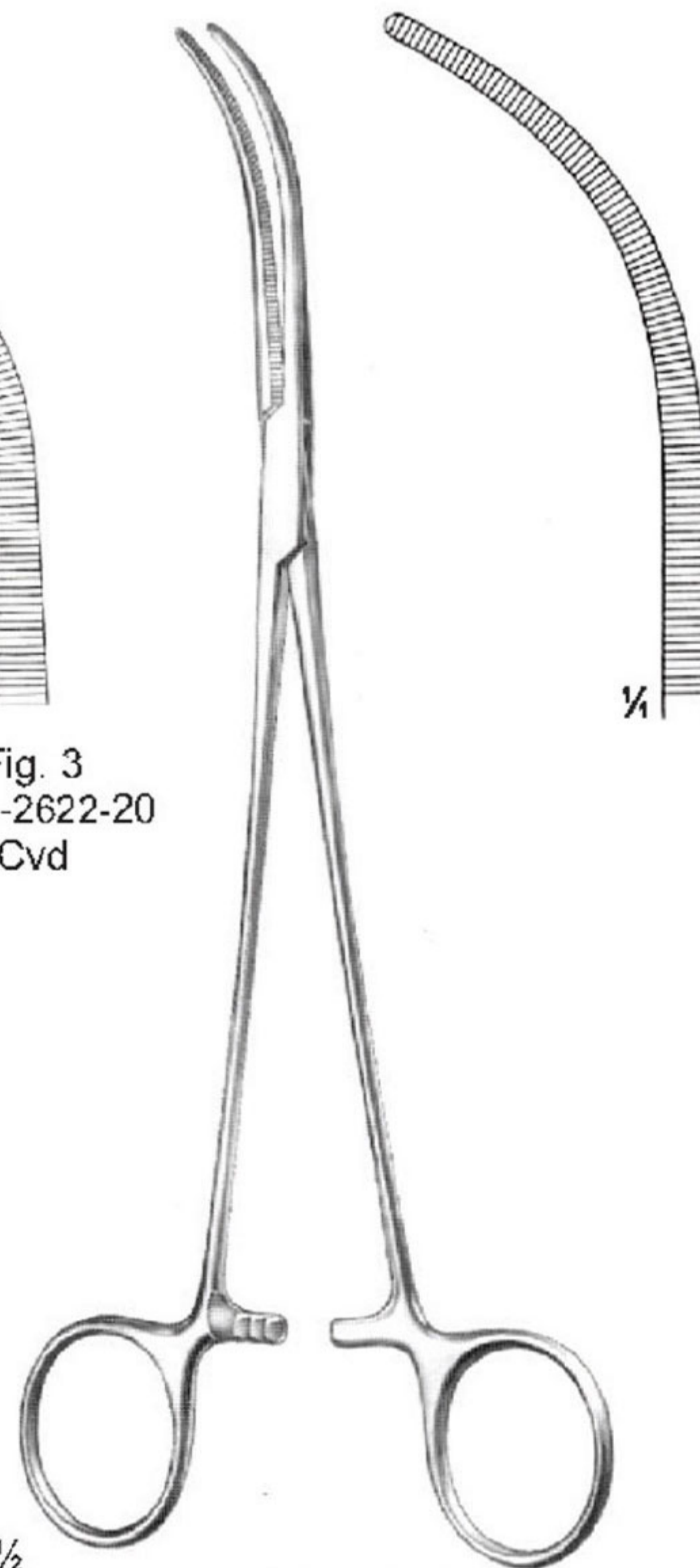
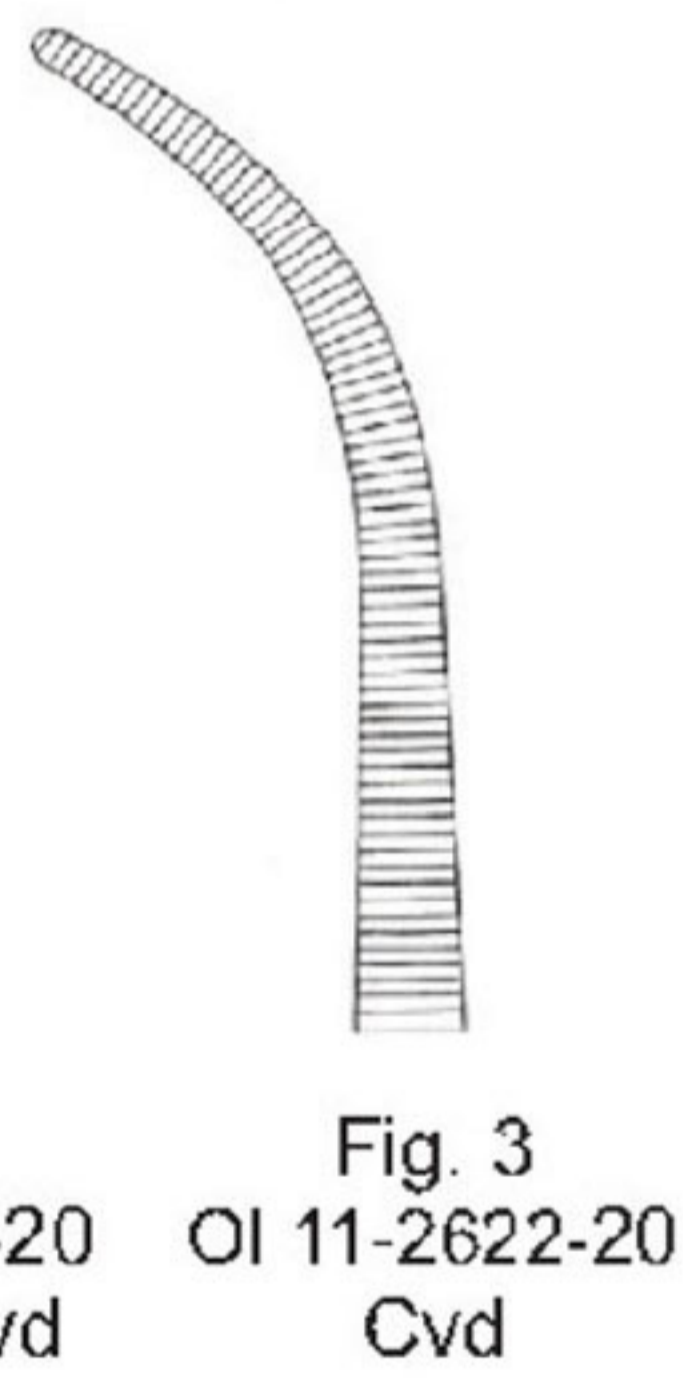
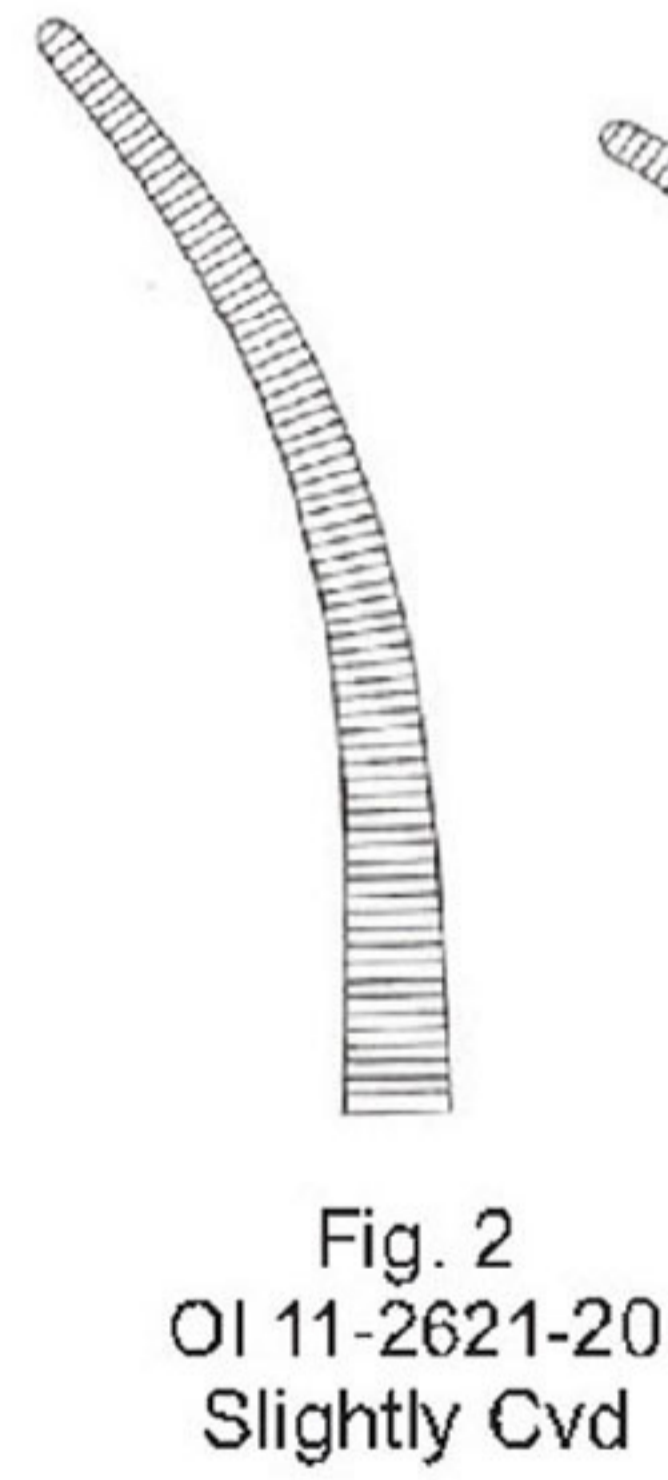
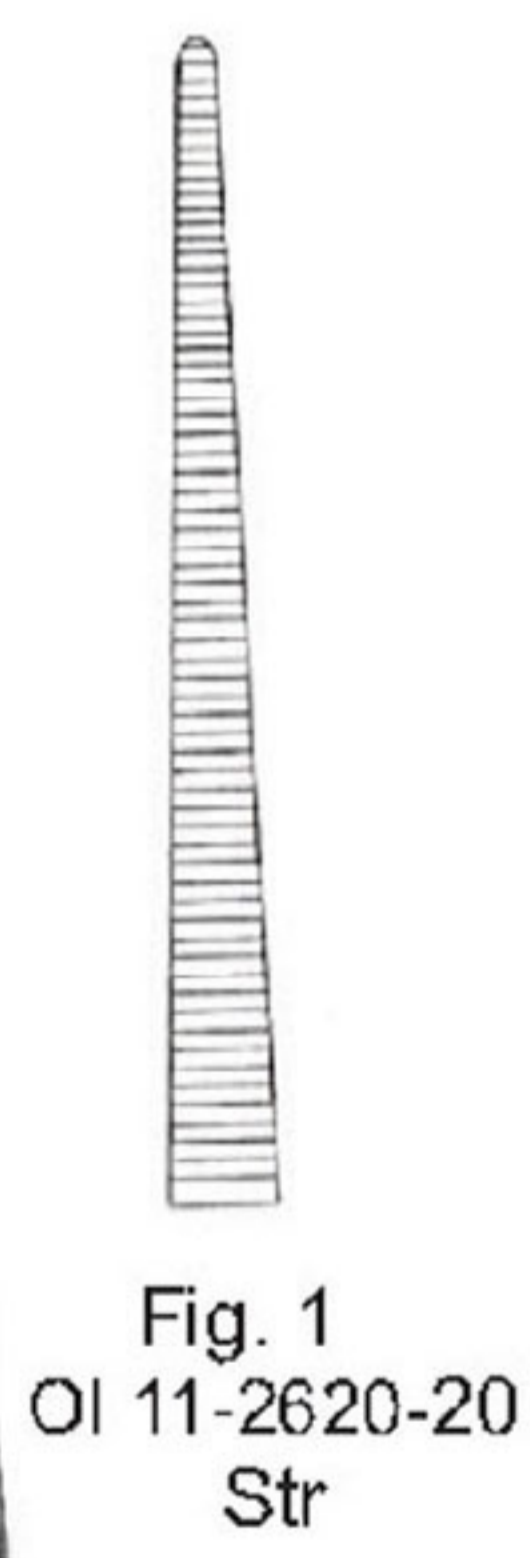

OVERHOLT-MIXTER
OI 11-2623-21
21 cm/8 1/4"

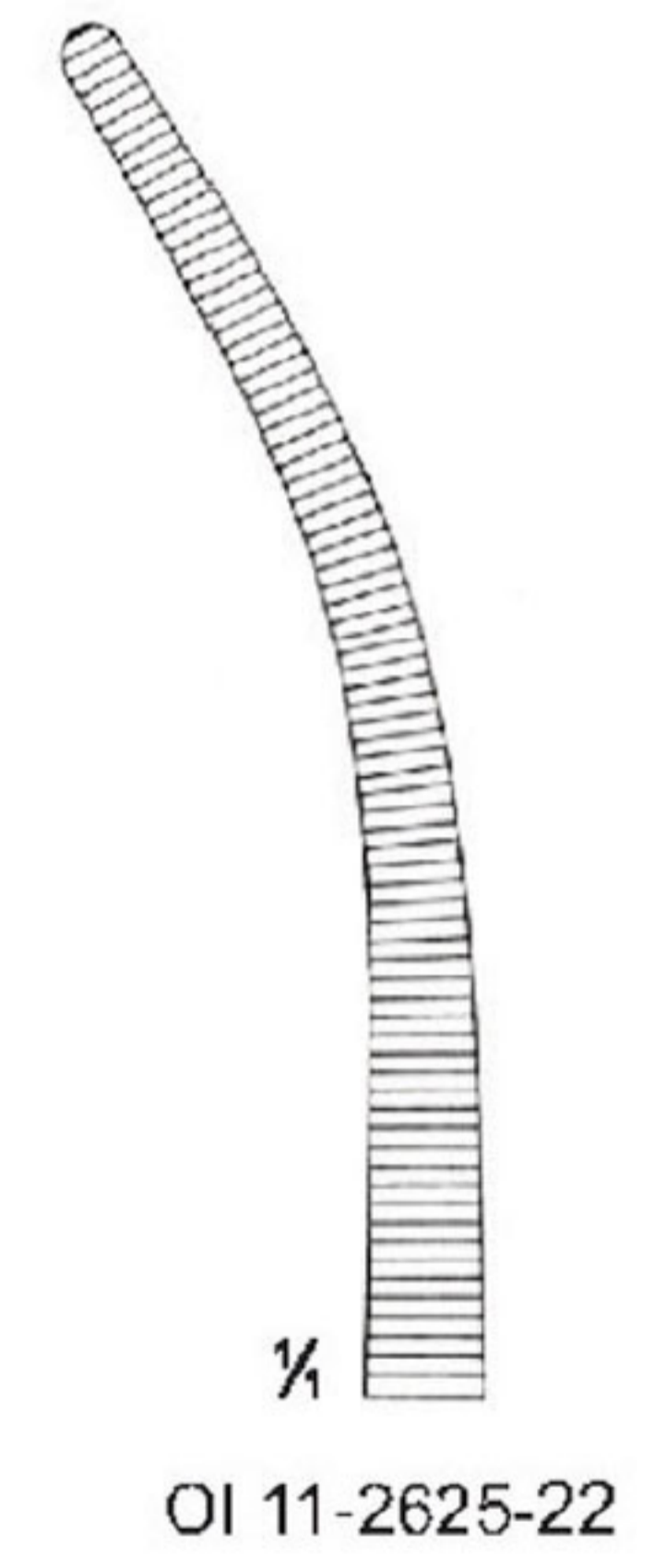
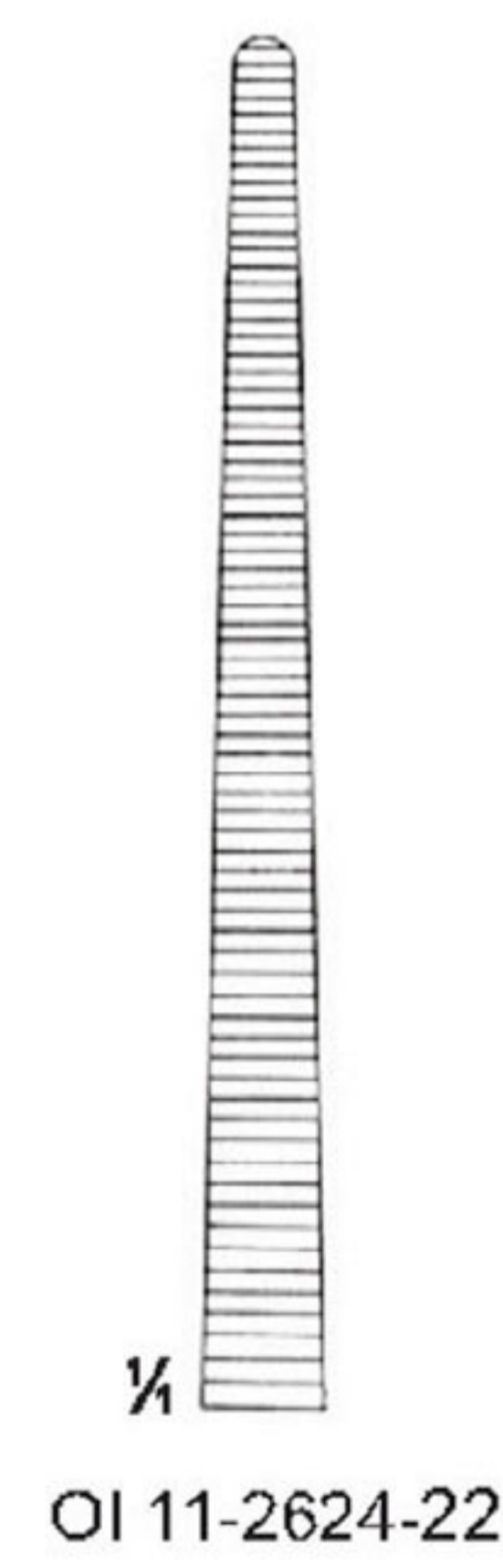

ROBERTS
22 cm/8 1/2"



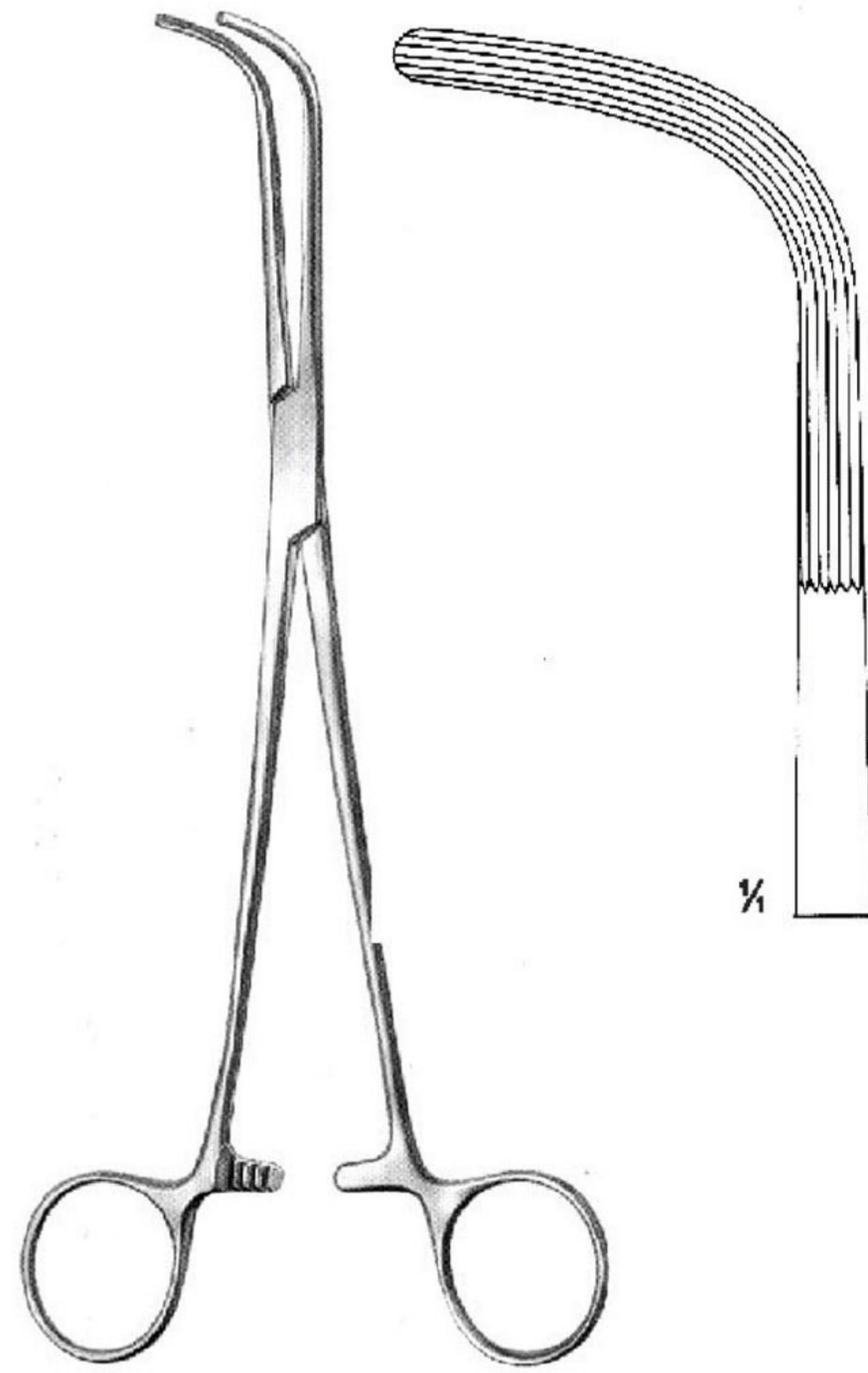

MCQUIGG-MIXTER
OI 11-2626-23
23.5 cm/9 1/4"

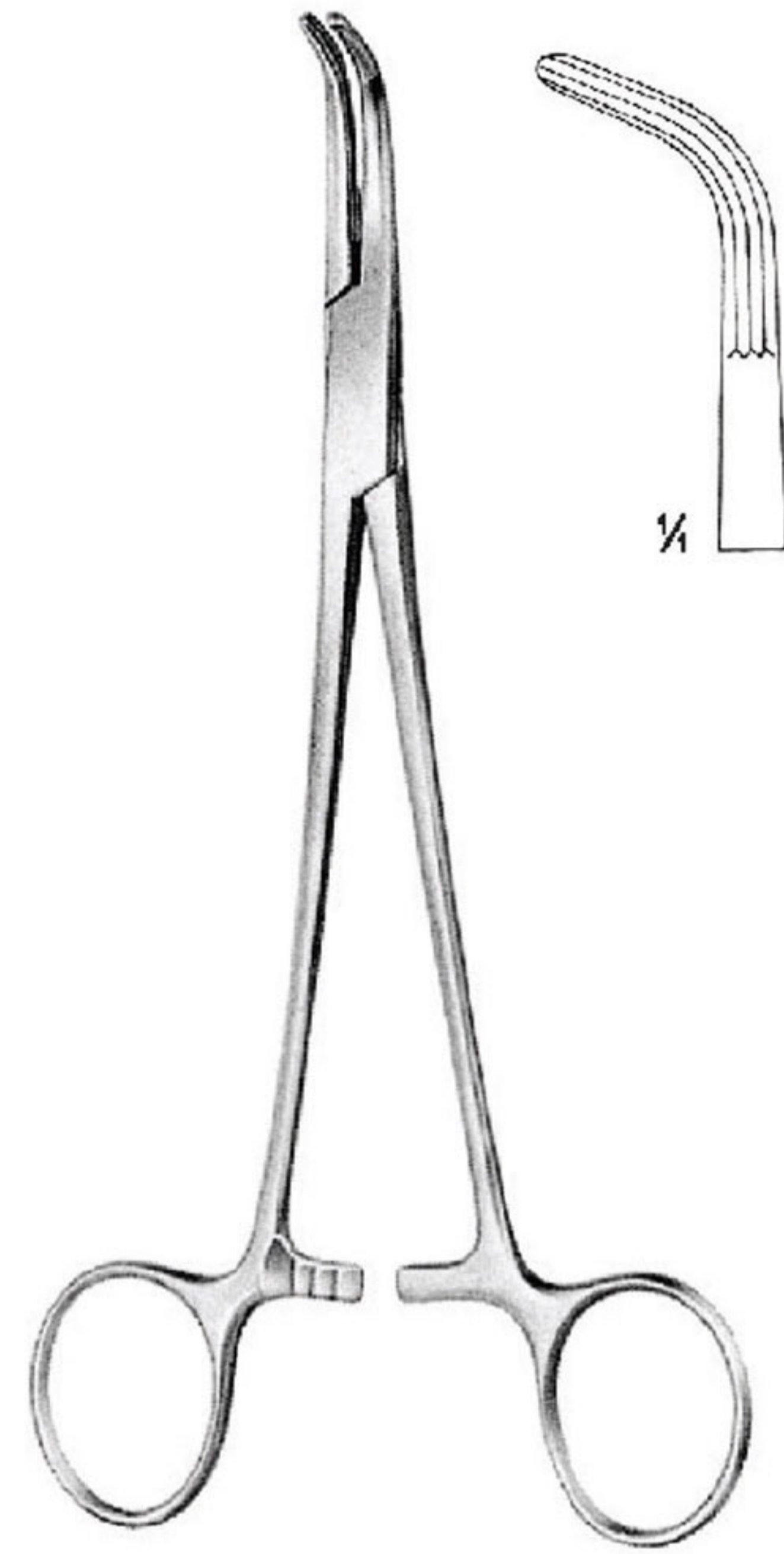

LAHEY
OI 11-2627-18
18.5 cm/7 1/4"



LAHEY

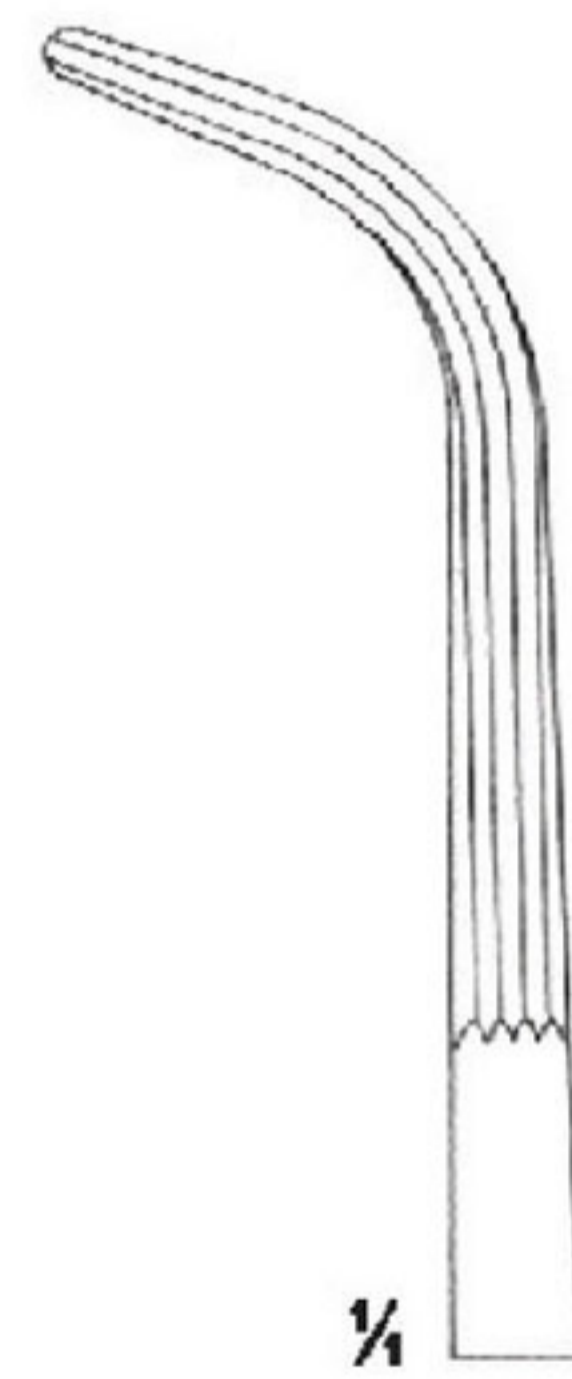

OI 11-2628-19
19.5 cm/7 1/2"

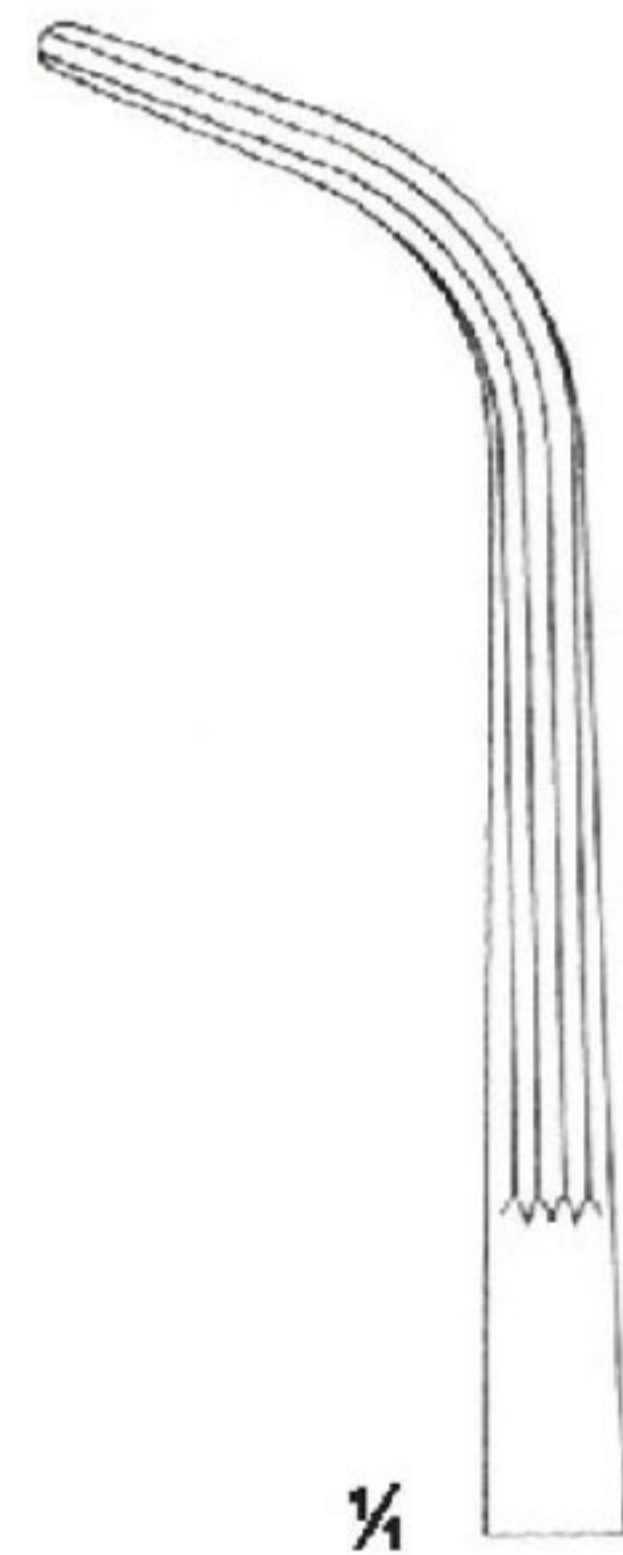

OI 11-2629-22
22.5 cm/8 3/4"

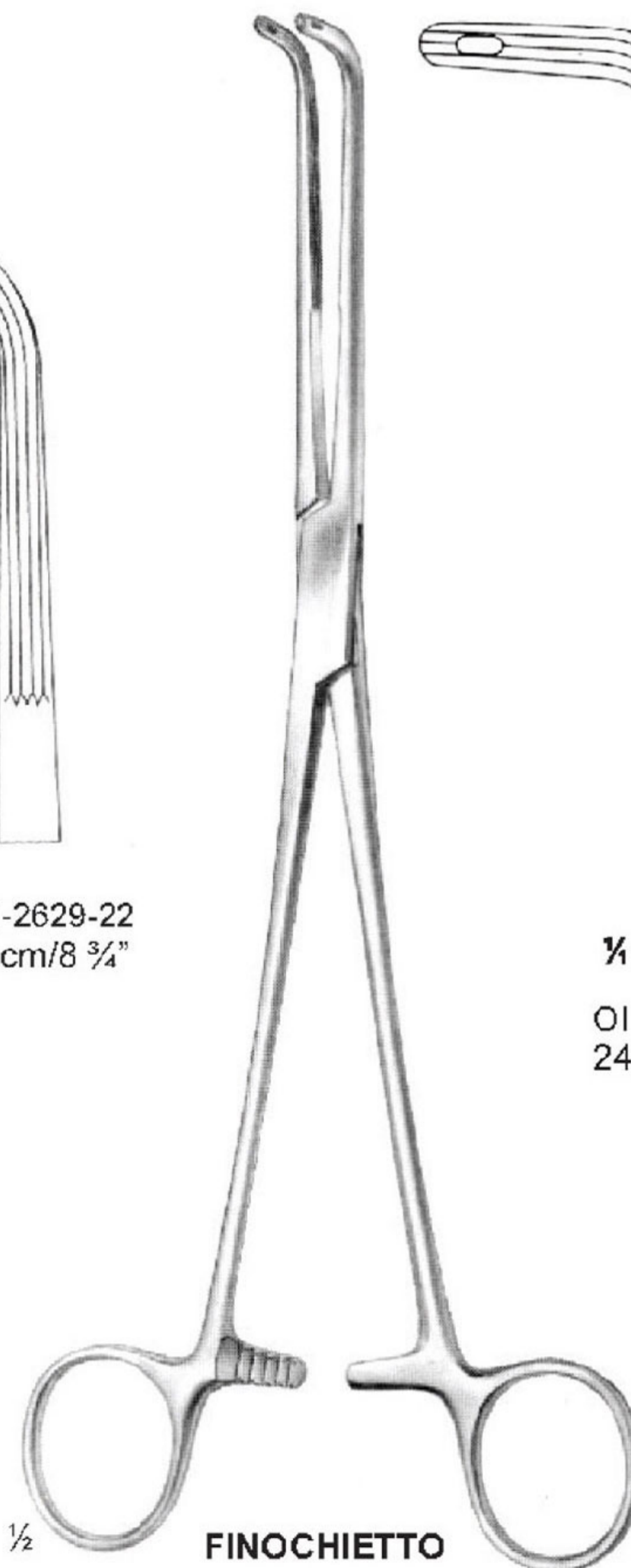

FINOCHIETTO



OI 11-2630-24
24.5 cm/9 5/8"

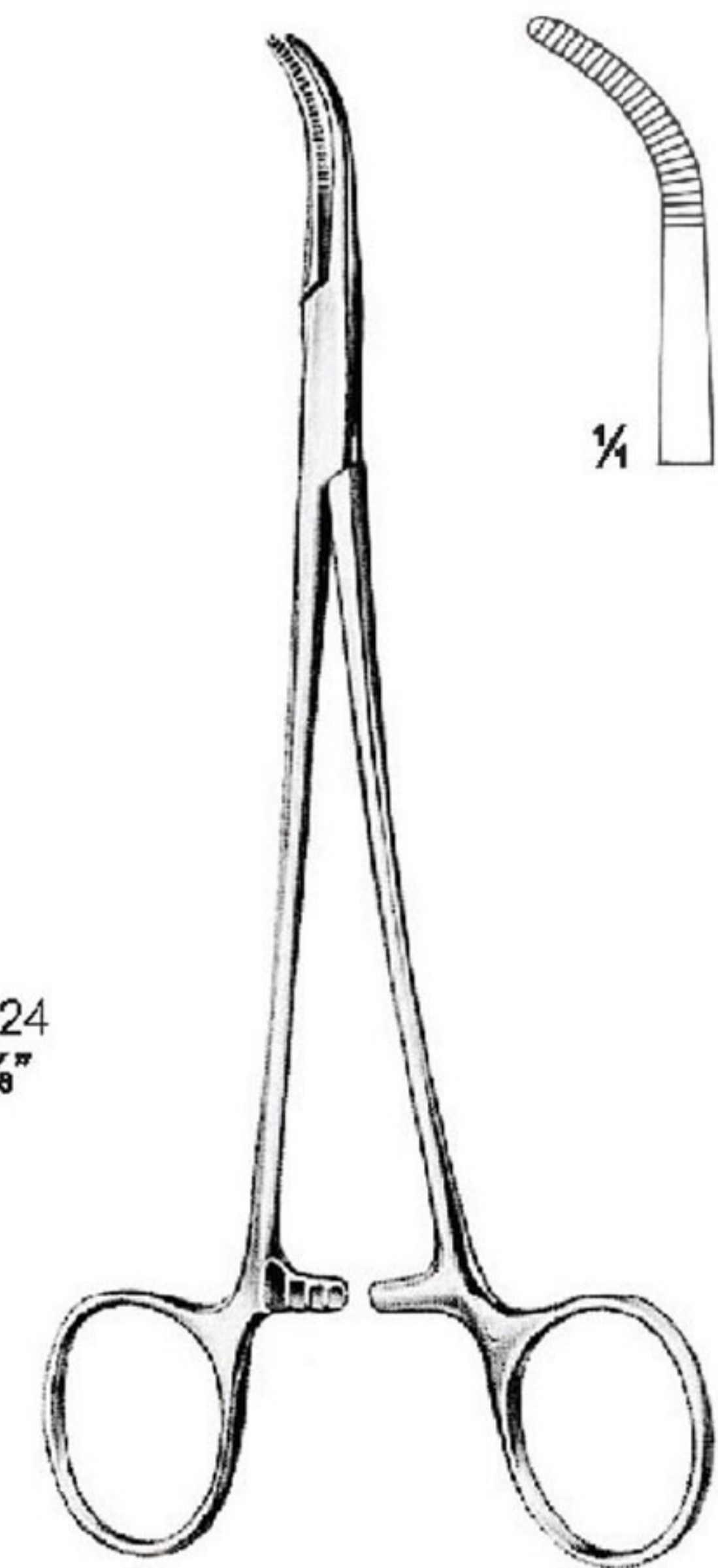

MIXTER-BABY
OI 11-2631-14
14 cm/5 1/2"

ARTERY FORCEPS



KELLY



Fig. 1
OI 11-2632-19
19 cm/7 1/2"

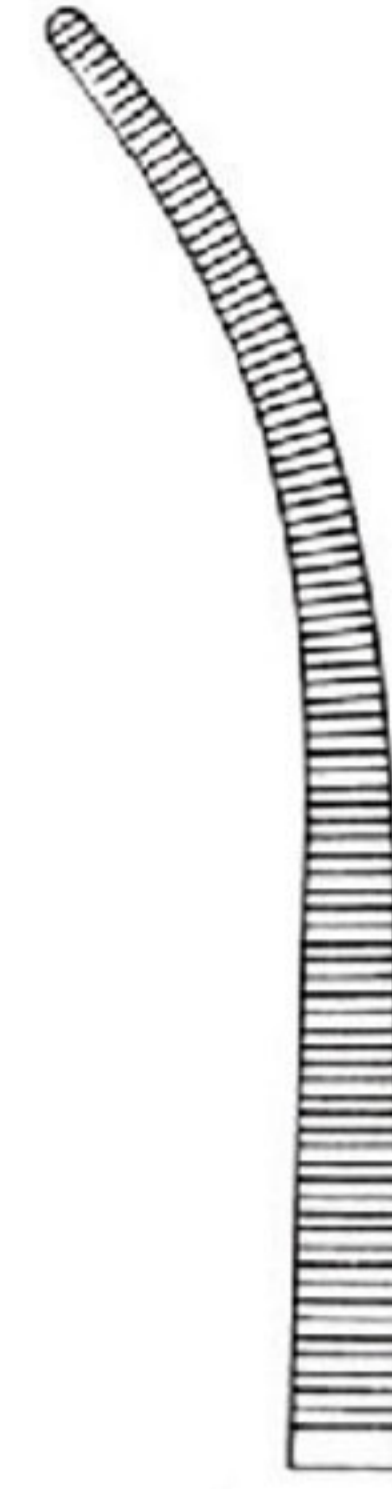

Fig. 1
OI 11-2632-22
22.5 cm/8 3/4"



Fig. 1
OI 11-2632-24
24.5 cm/9 5/8"



Fig. 2
OI 11-2633-19
19 cm/7 1/2"



Fig. 2
OI 11-2633-22
22 cm/8 1/2"



Fig. 2
OI 11-2633-23
23.5 cm/9 1/4"



Fig. 3
OI 11-2634-18
18.5 cm/7 1/4"



Fig. 3
OI 11-2634-21
21.5 cm/8 1/2"



Fig. 3
OI 11-2634-23
23.5 cm/9 1/4"





LAWRENCE
OI 11-2635-28
28 cm/11"



WIKSTROEM



OI 11-2636-21
21 cm/8 1/4"



OI 11-2636-24
24.5 cm/9 5/8"



MEEKER
OI 11-2637-28
28 cm/11"

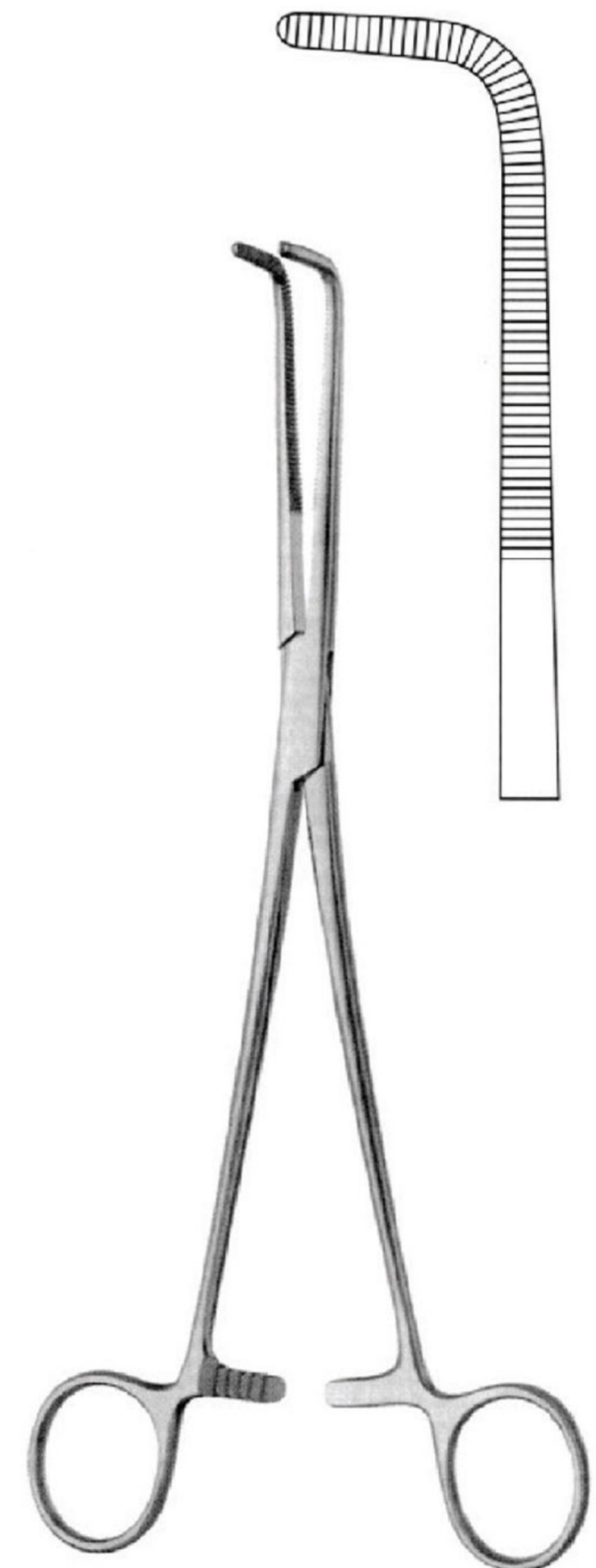

MIXTER-CRAFOORD
OI 11-2638-25 25 cm/9 7/8"
OI 11-2638-27 27 cm/10 1/2"

ARTERY FORCEPS



MINI-GEMINI

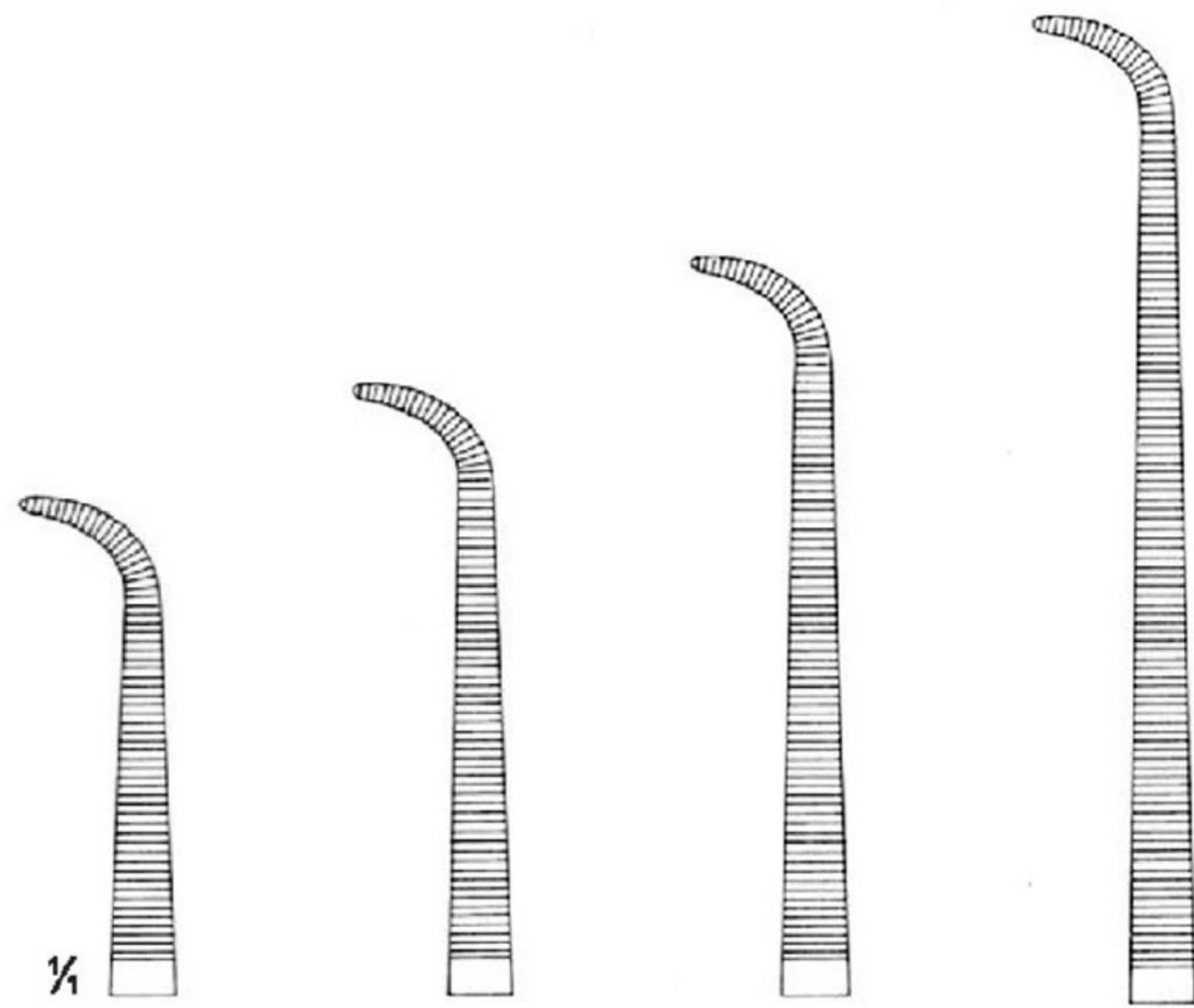

- OI 11-2639-18 18 cm/7 1/8"
- OI 11-2639-22 22.5 cm/8 3/4"
- OI 11-2639-25 25 cm/9 1/2"
- OI 11-2639-28 28.5 cm/11 1/4"



GEMINI

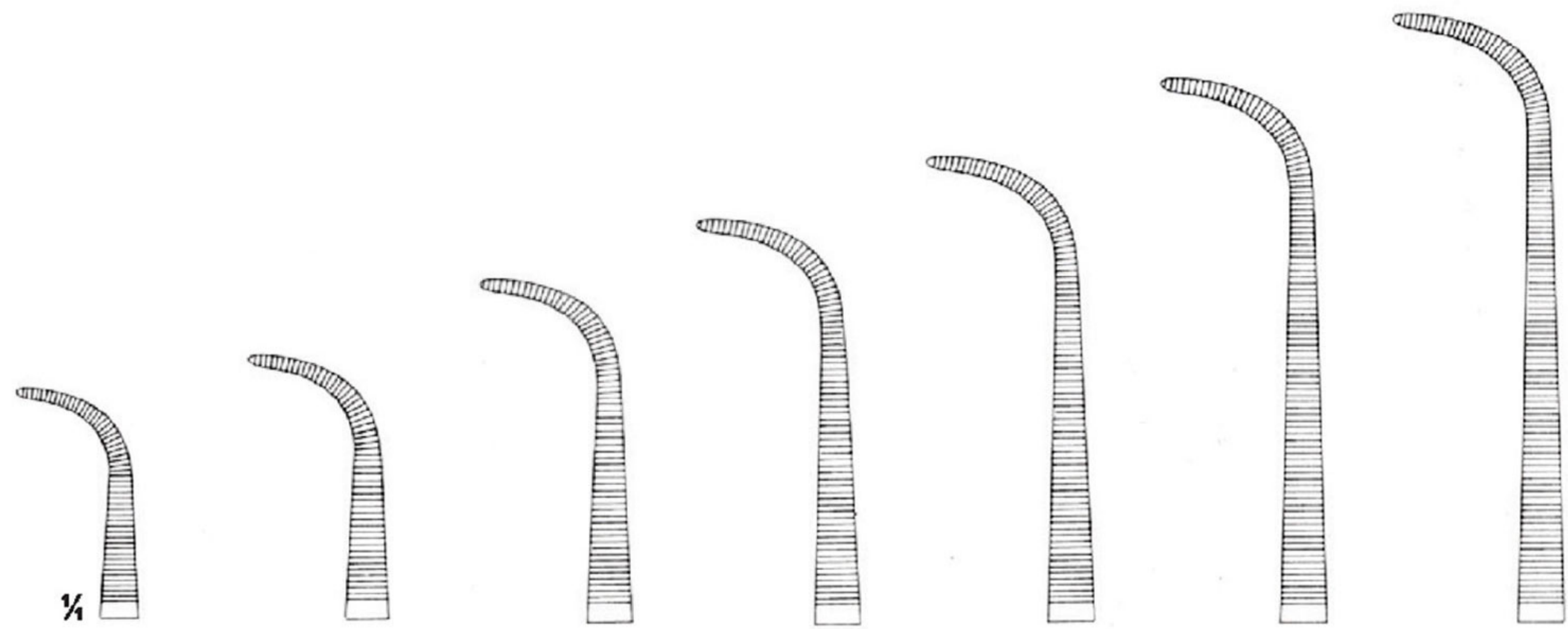

- OI 11-2640-13 13 cm/5 1/8"
- OI 11-2640-16 16 cm/6 1/4"
- OI 11-2640-18 18 cm/7 1/8"
- OI 11-2640-21 21 cm/8 1/4"
- OI 11-2640-23 23 cm/9"
- OI 11-2640-25 25 cm/9 1/2"
- OI 11-2640-28 28 cm/11"



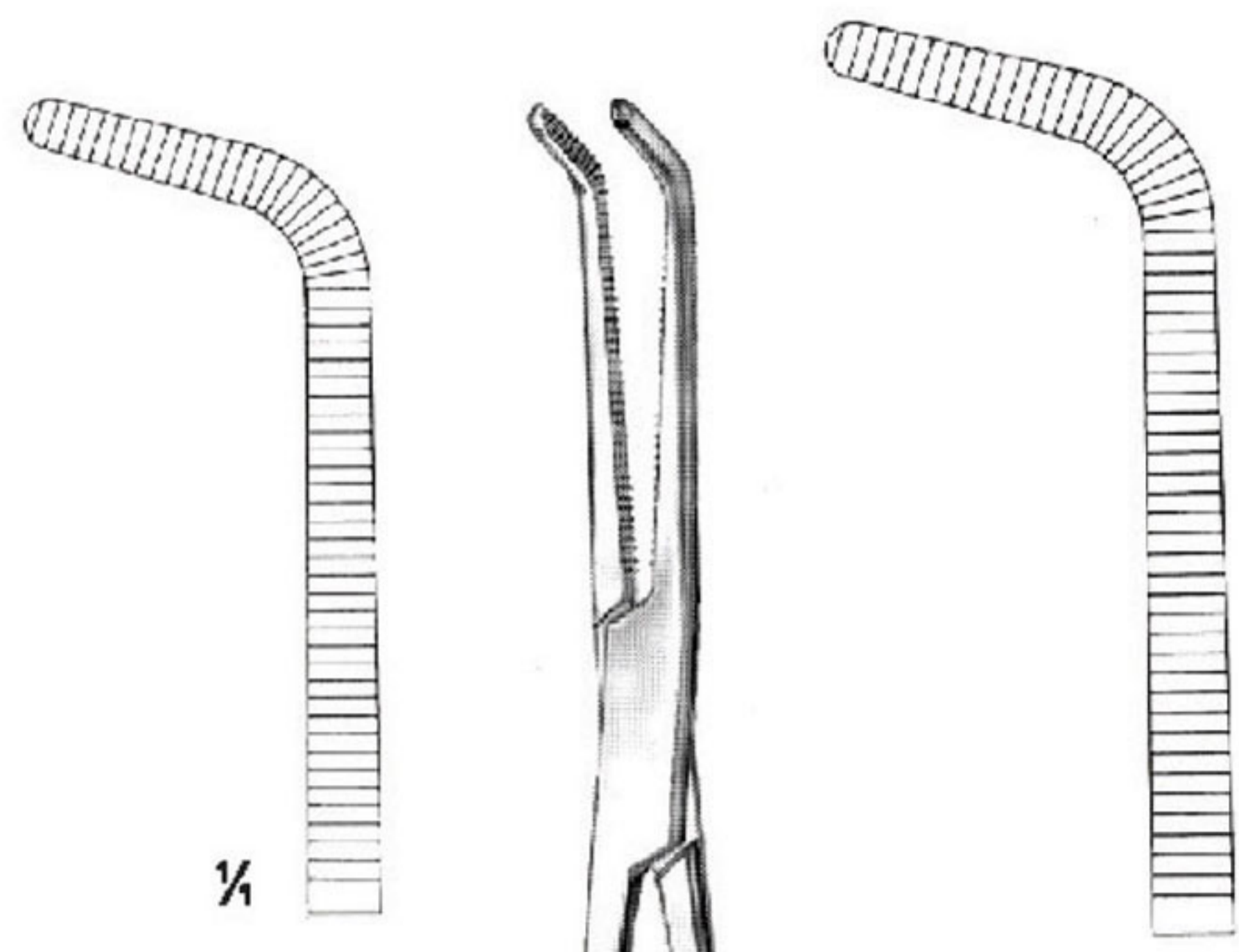

1/4

MIXTER

- OI 11-2641-14 14.5 cm/5 3/4"
- OI 11-2641-15 15.5 cm/6 1/8"
- OI 11-2641-19 19 cm/7 1/2"

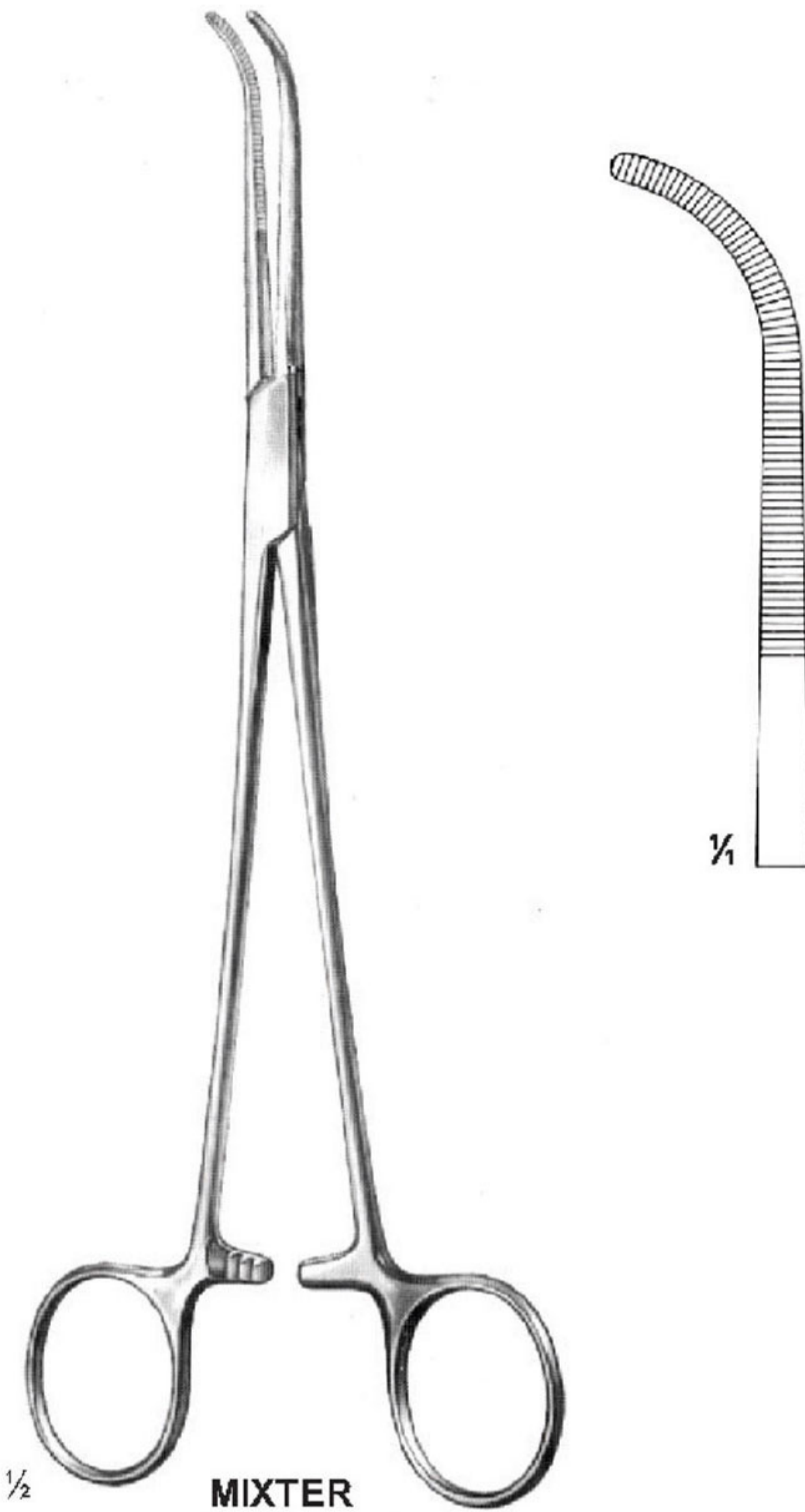

1/4

1/2

MIXTER

- OI 11-2642-22
22 cm/8 1/2"

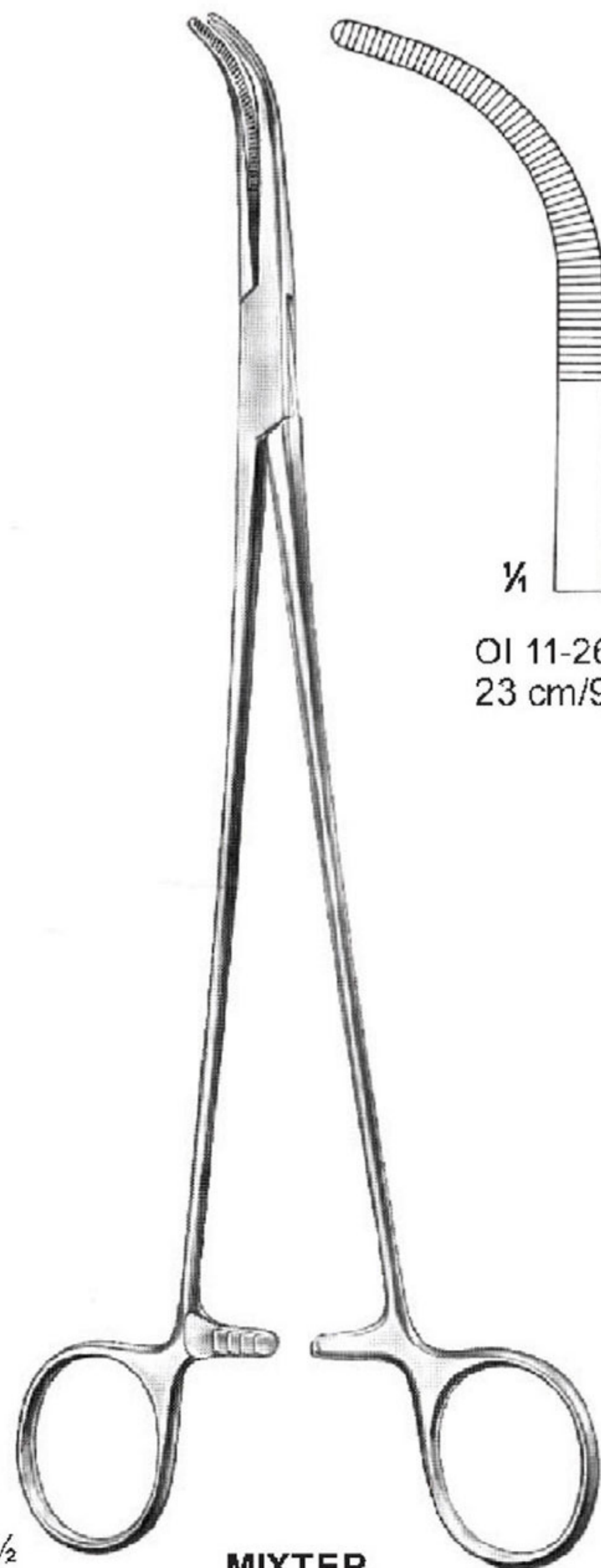

1/4

- OI 11-2643-23
23 cm/9"

1/2

MIXTER

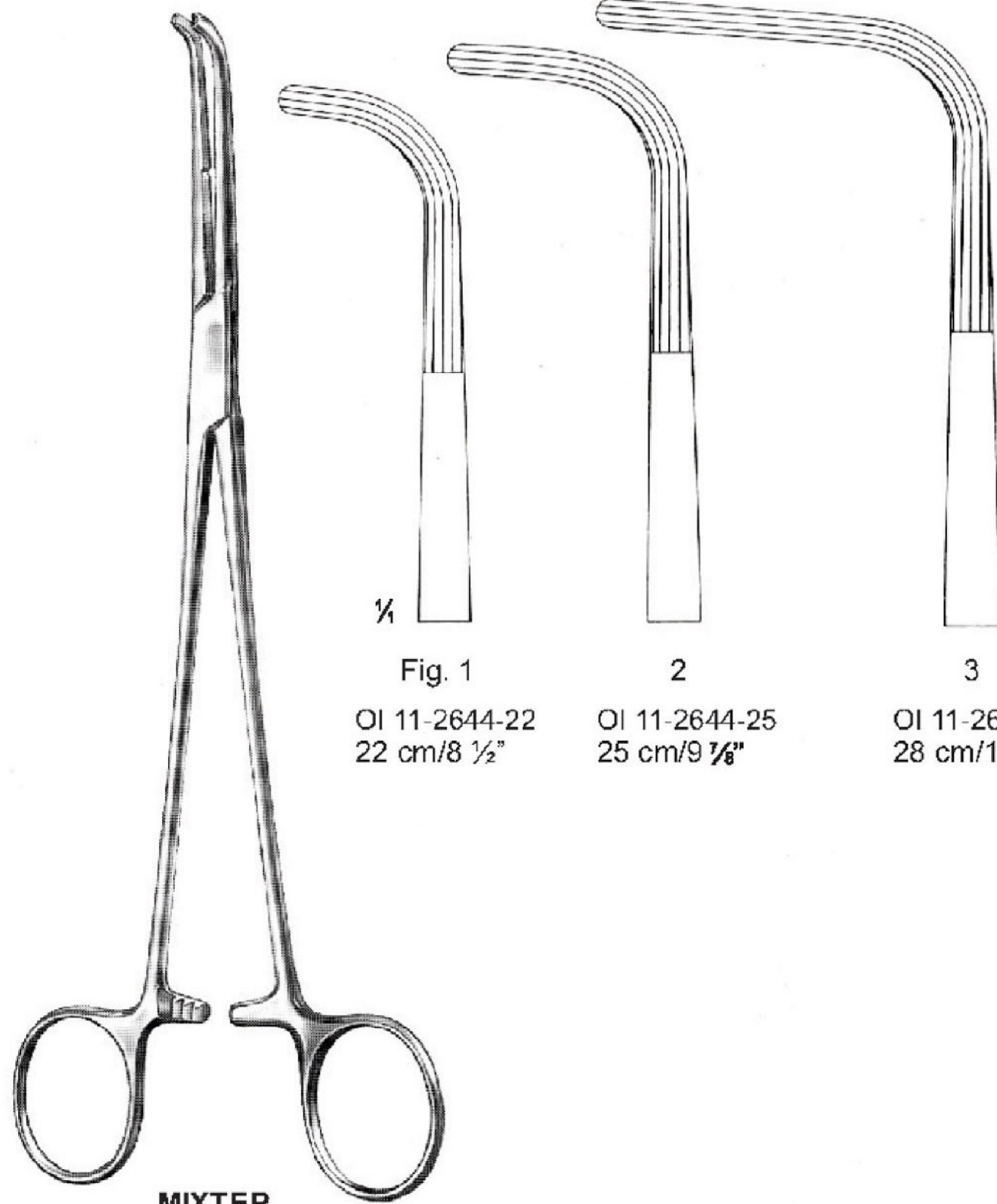

1/4

Fig. 1

- OI 11-2644-22
22 cm/8 1/2"

2

- OI 11-2644-25
25 cm/9 7/8"

3

- OI 11-2644-28
28 cm/11"

MIXTER

ARTERY FORCEPS

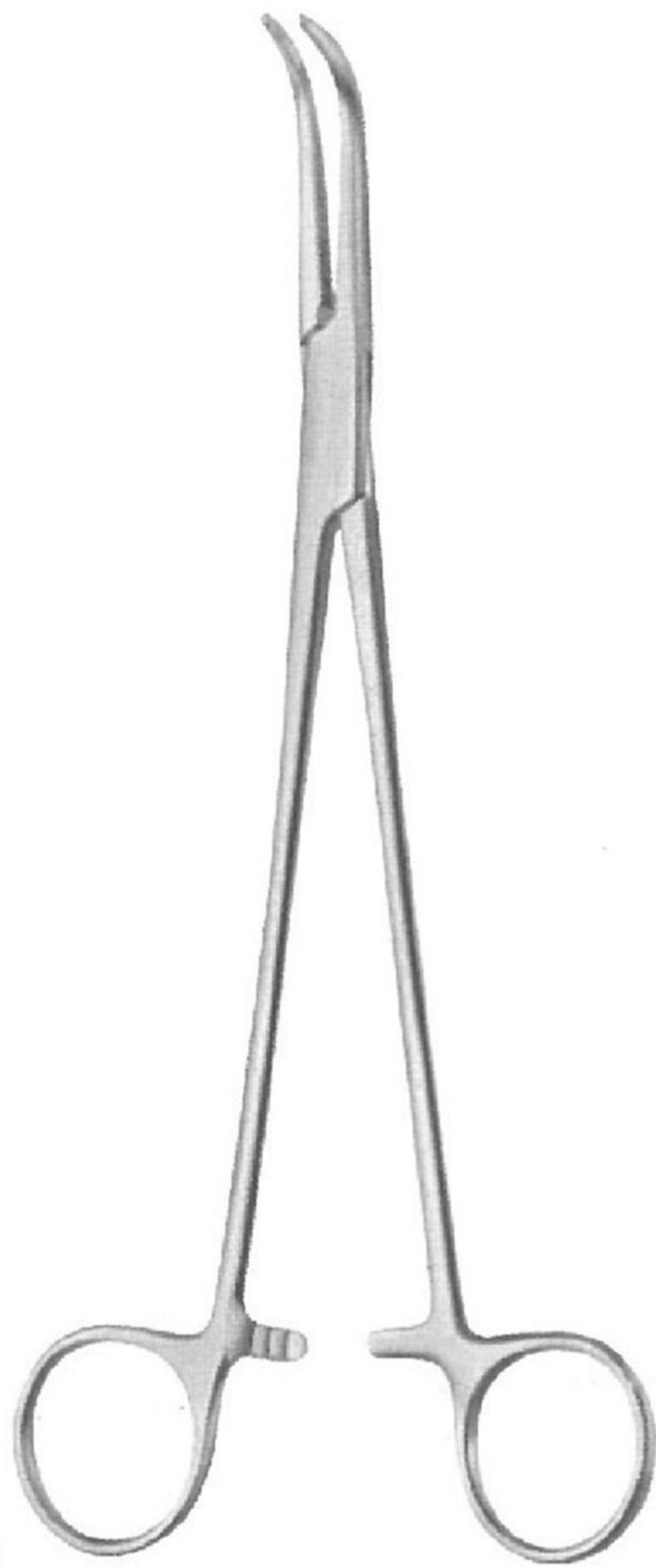

O'SHAUGNESSY

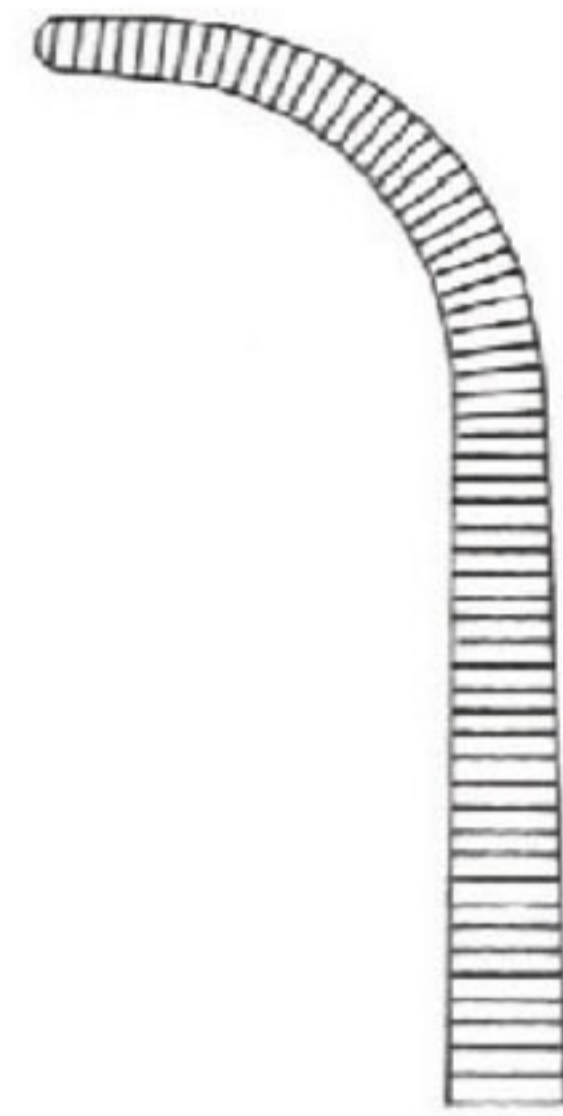

OI 11-2645-15
15 cm/5 7/8"

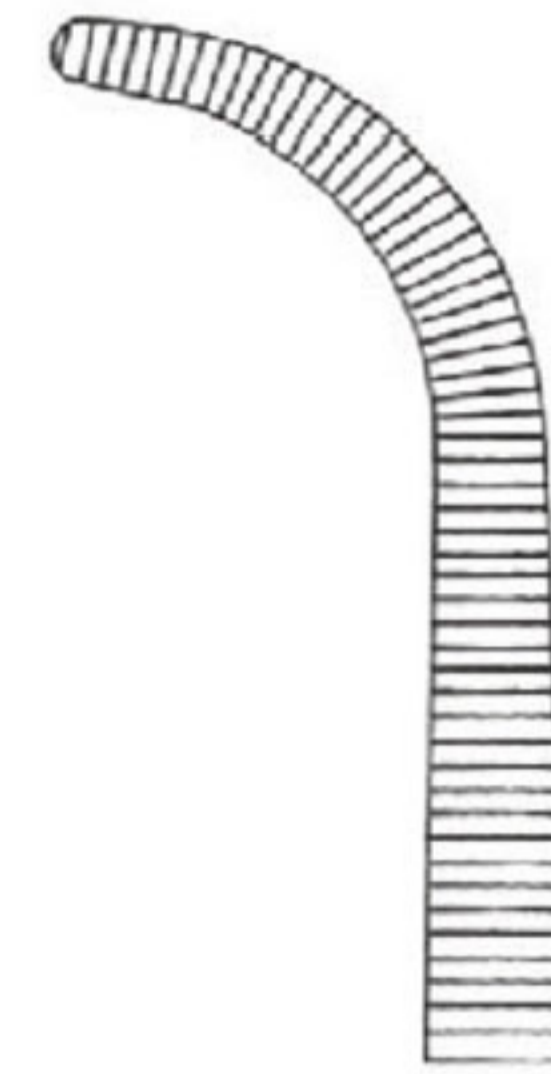

OI 11-2645-18
18 cm/7 1/8"



OI 11-2645-19
18.5 cm/7 1/4"



OI 11-2645-20
20 cm/7 7/8"

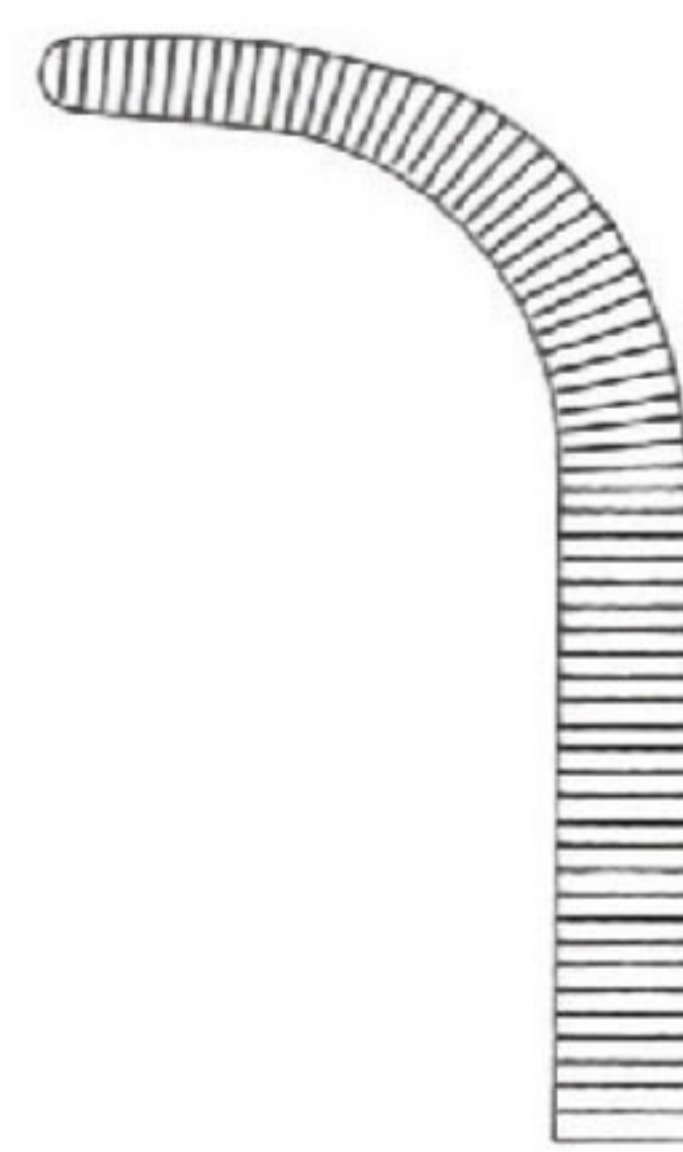

OI 11-2645-23
23 cm/9"



OI 11-2645-26
26 cm/10 1/4"



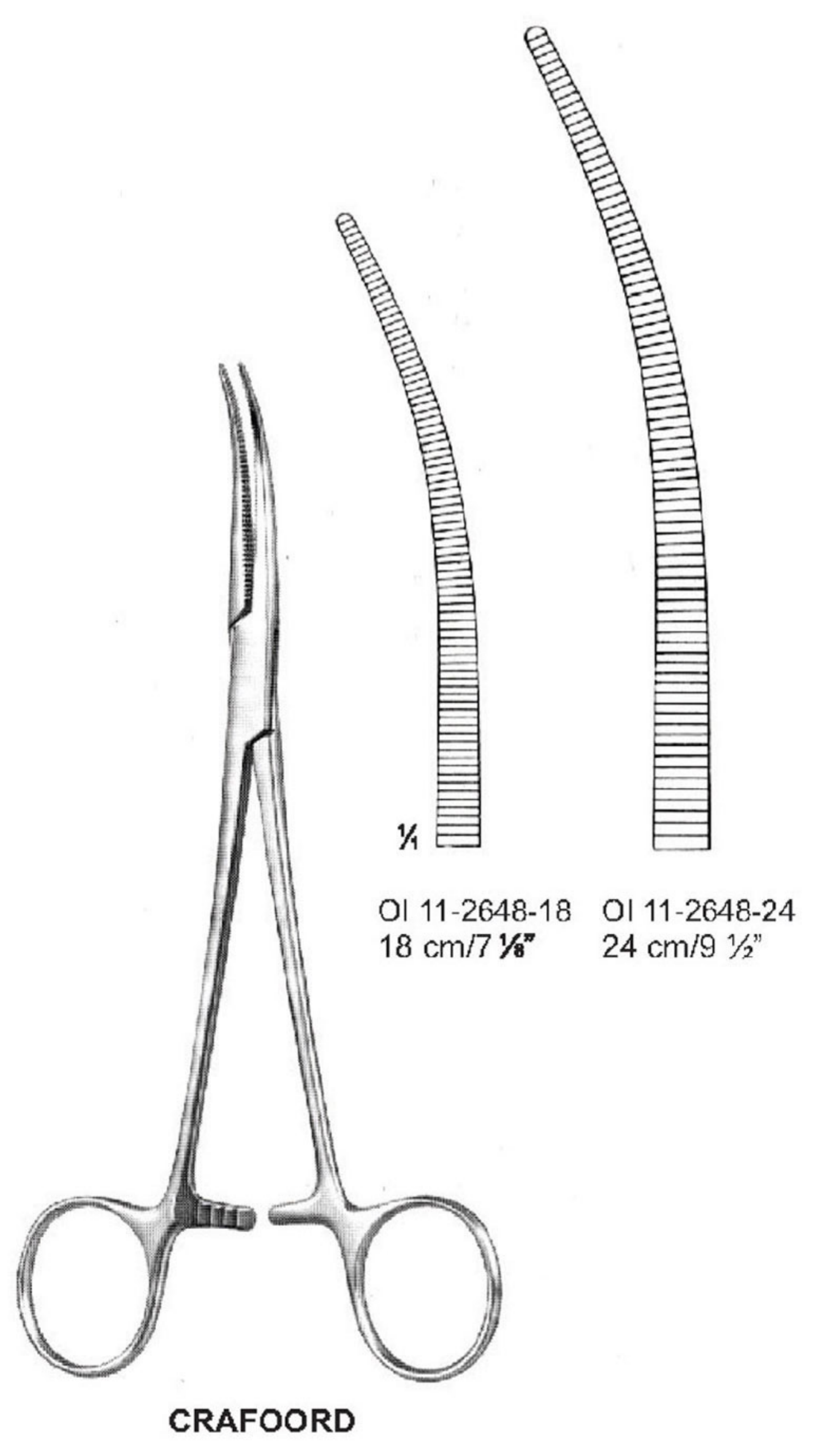
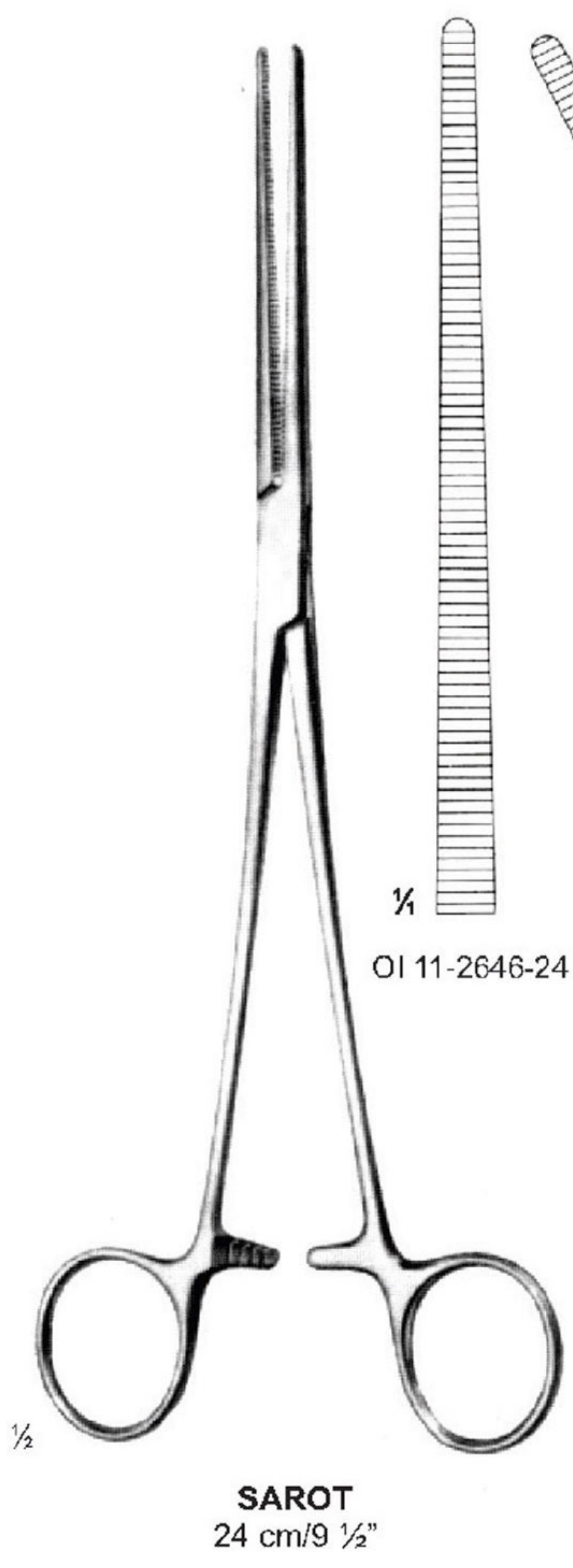

ARTERY FORCEPS



CRAFOORD-SELLORS
24 cm/9 $\frac{1}{2}$ "
Vascular Clamp

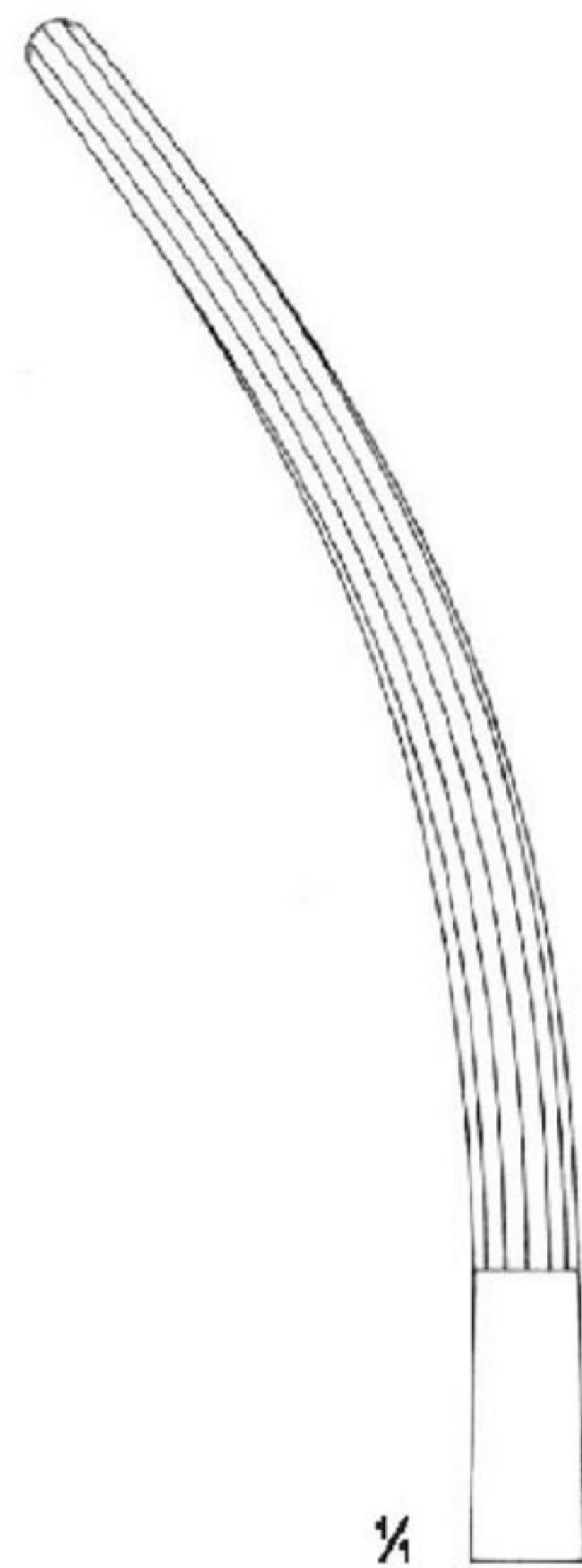

OI 11-2649-24

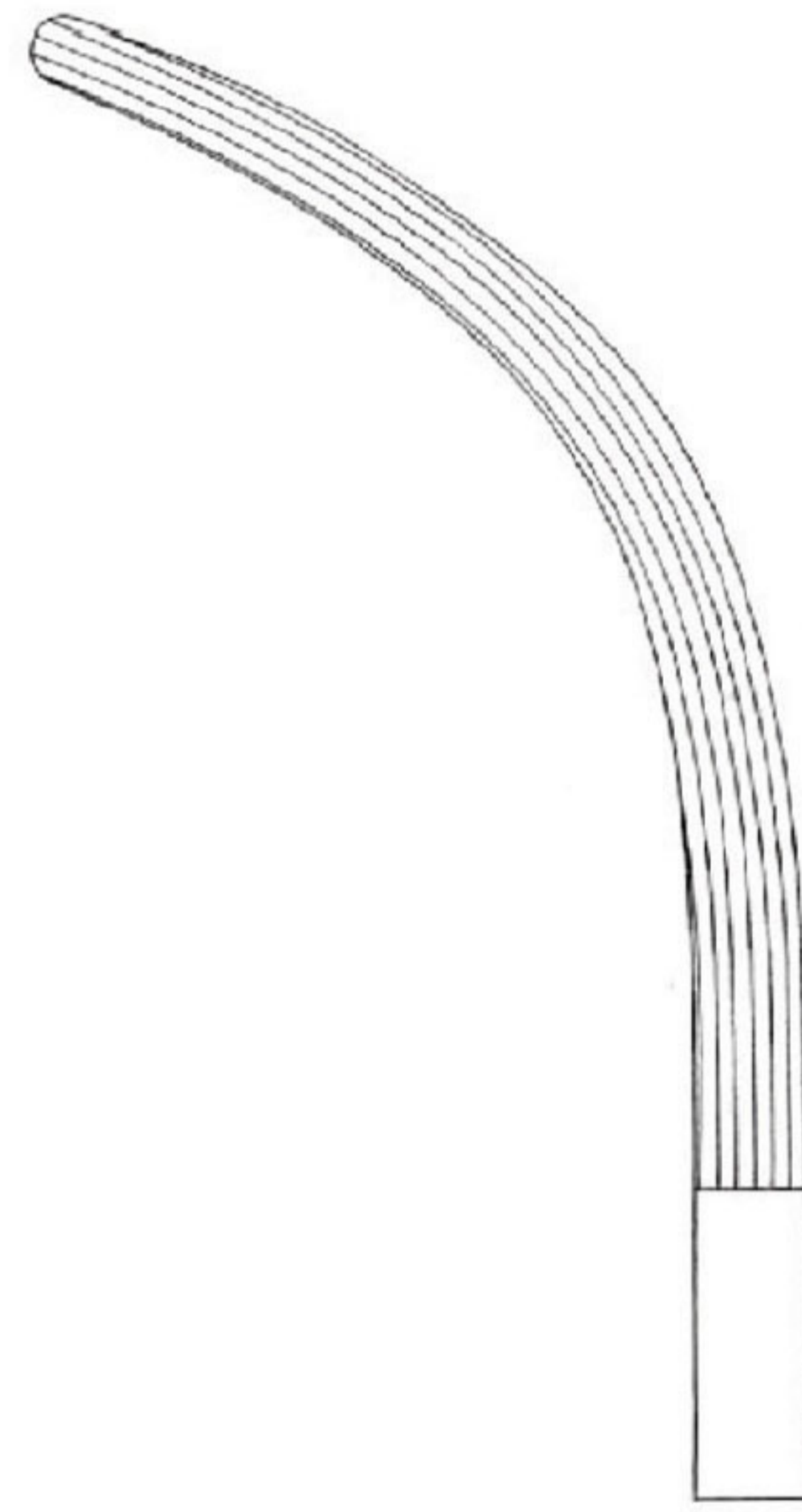

OI 11-2650-24

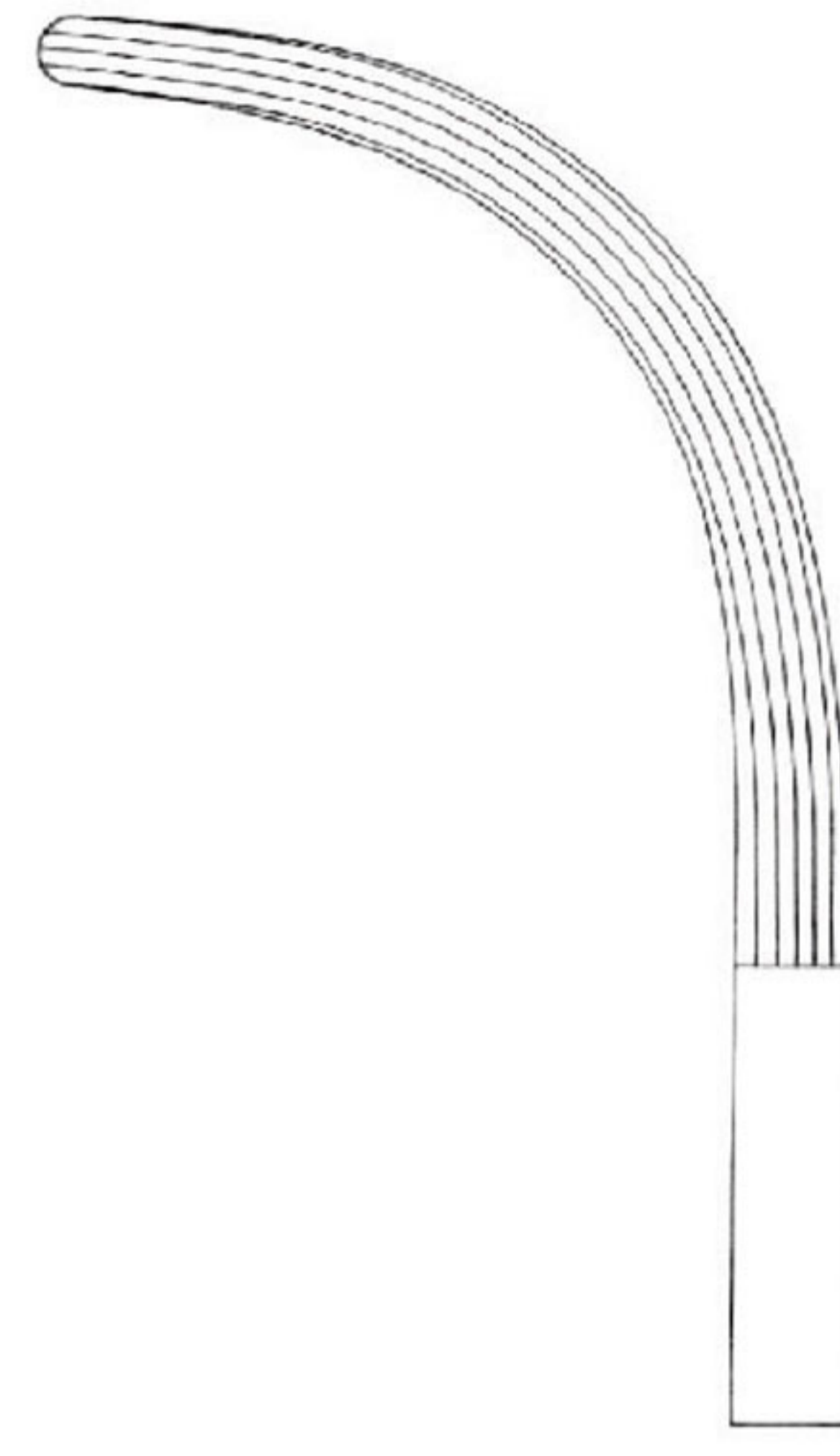

OI 11-2651-24



JOHNS HOPKINS
OI 11-2652-20
20 cm/7 $\frac{7}{8}$ "

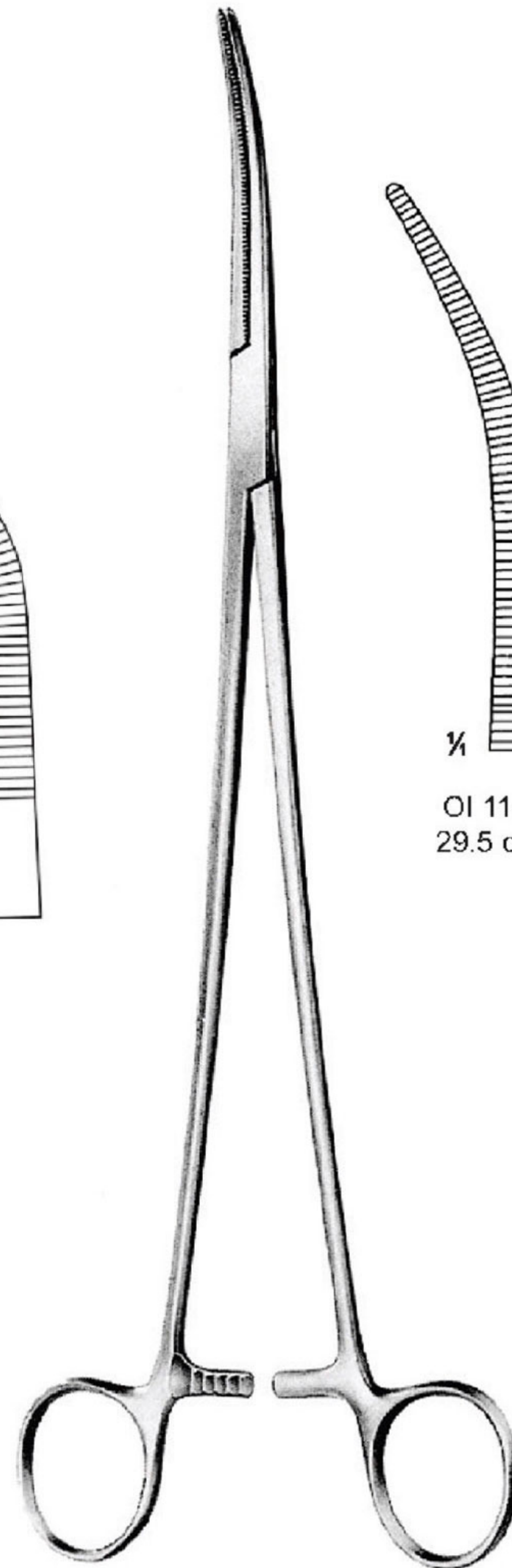
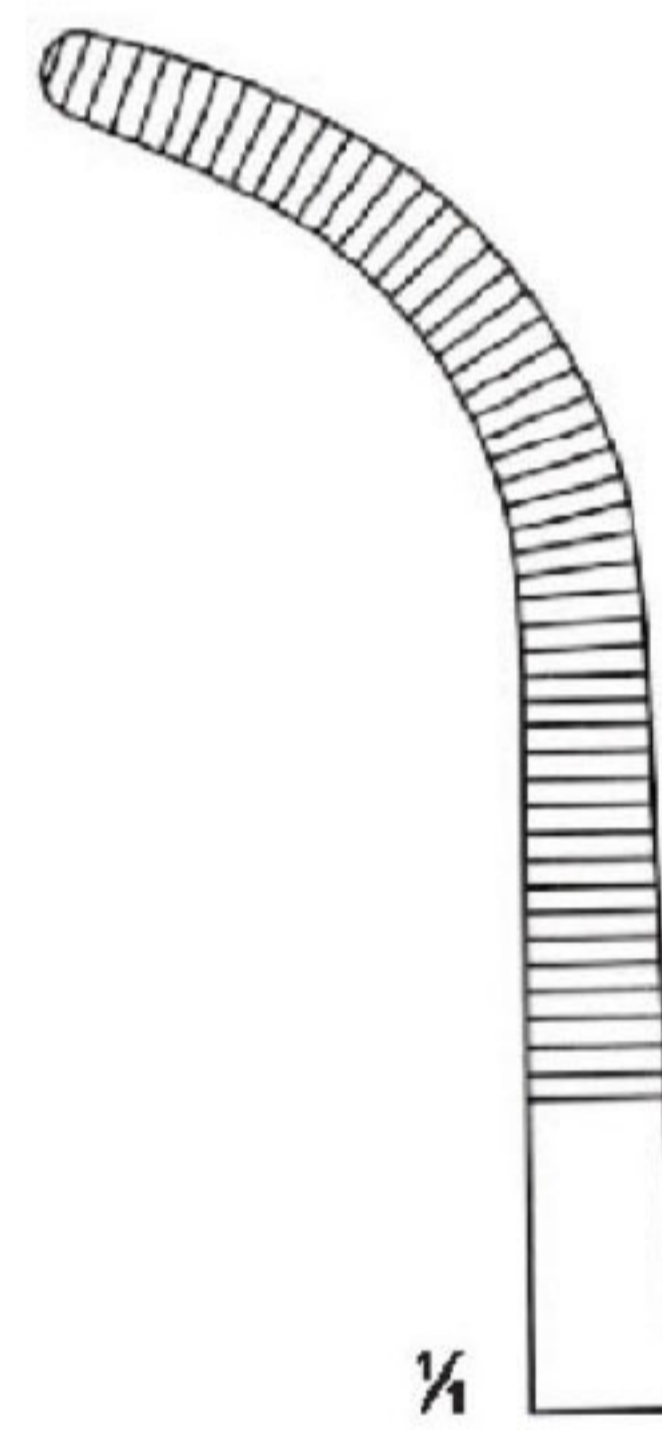

ZENKER

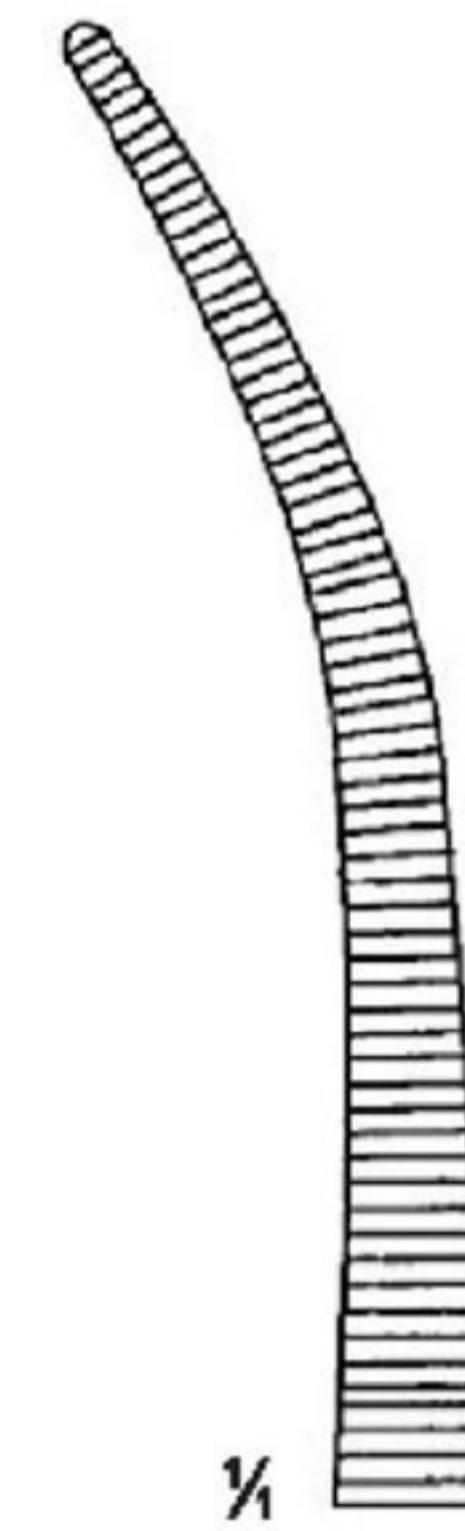

OI 11-2653-29
29.5 cm/11 $\frac{5}{8}$ "

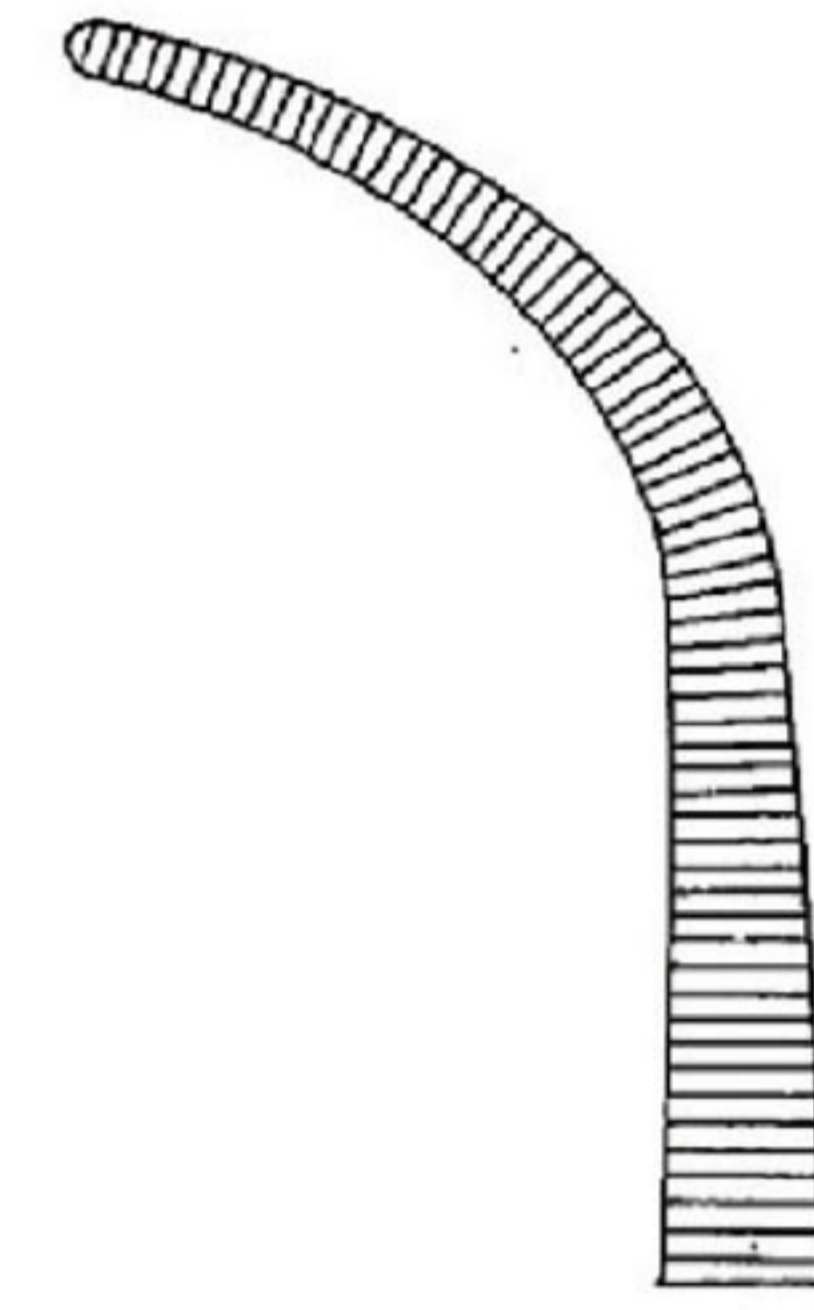

OI 11-2653-28
28.5 cm/11 $\frac{1}{4}$ "



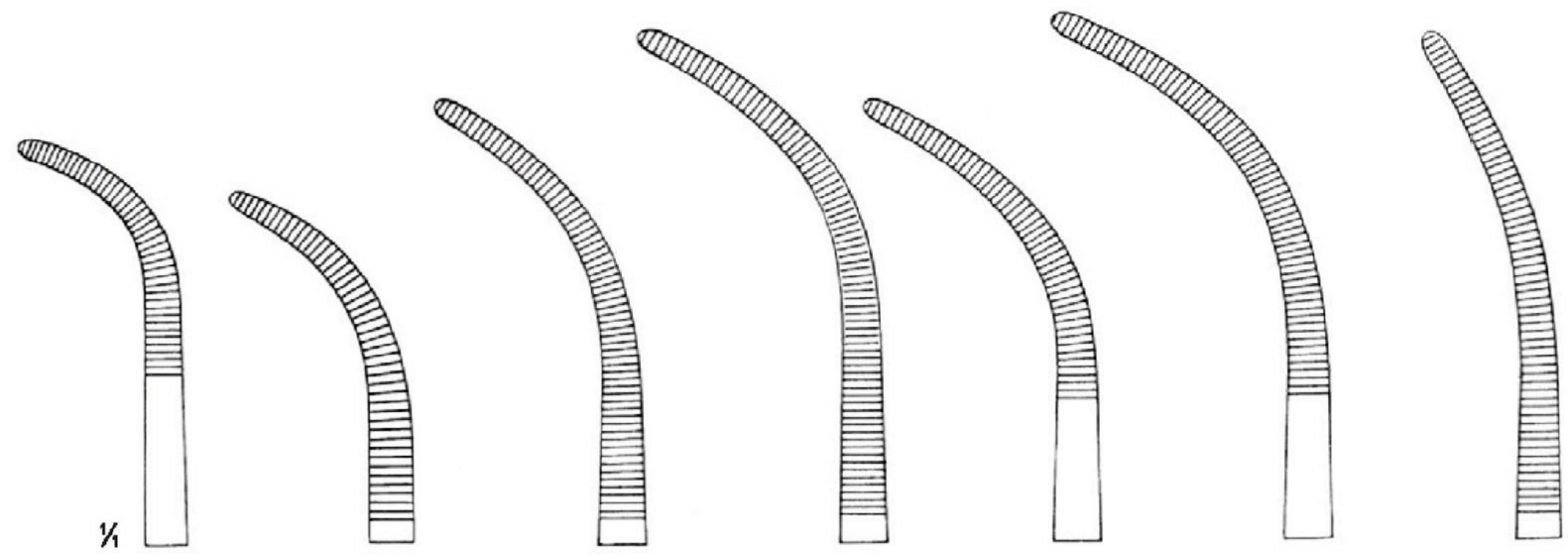

Fig. 1 OI 11-2654-20 20.5 cm/8 1/8"	Fig. 2 OI 11-2655-20 20 cm/7 7/8"	Fig. 3 OI 11-2655-21 21.5 cm/8 1/2"	Fig. 4 OI 11-2655-22 22 cm/8 1/2"	Fig. 5 OI 11-2656-21 21.5 cm/8 1/2"	Fig. 6 OI 11-2656-22 22 cm/8 1/2"	Fig. 7 OI 11-2657-22 22 cm/8 1/2"
---	---	---	---	---	---	---



OVERHOLT-GEISSENDORFER

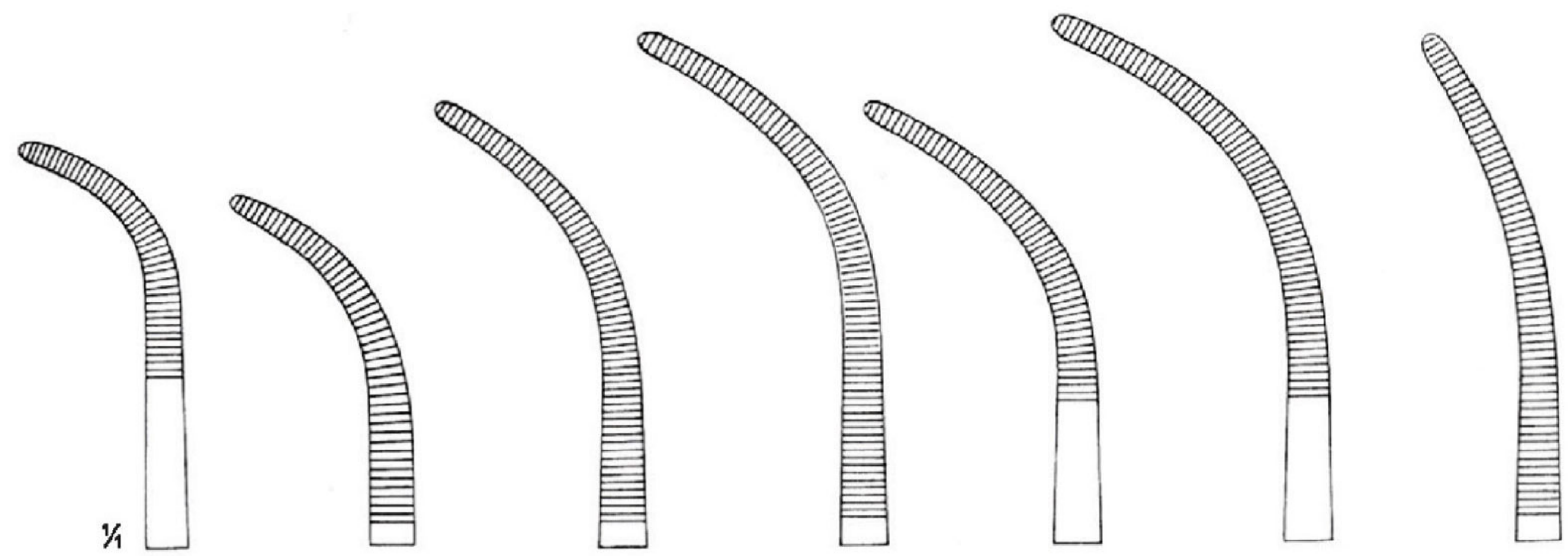
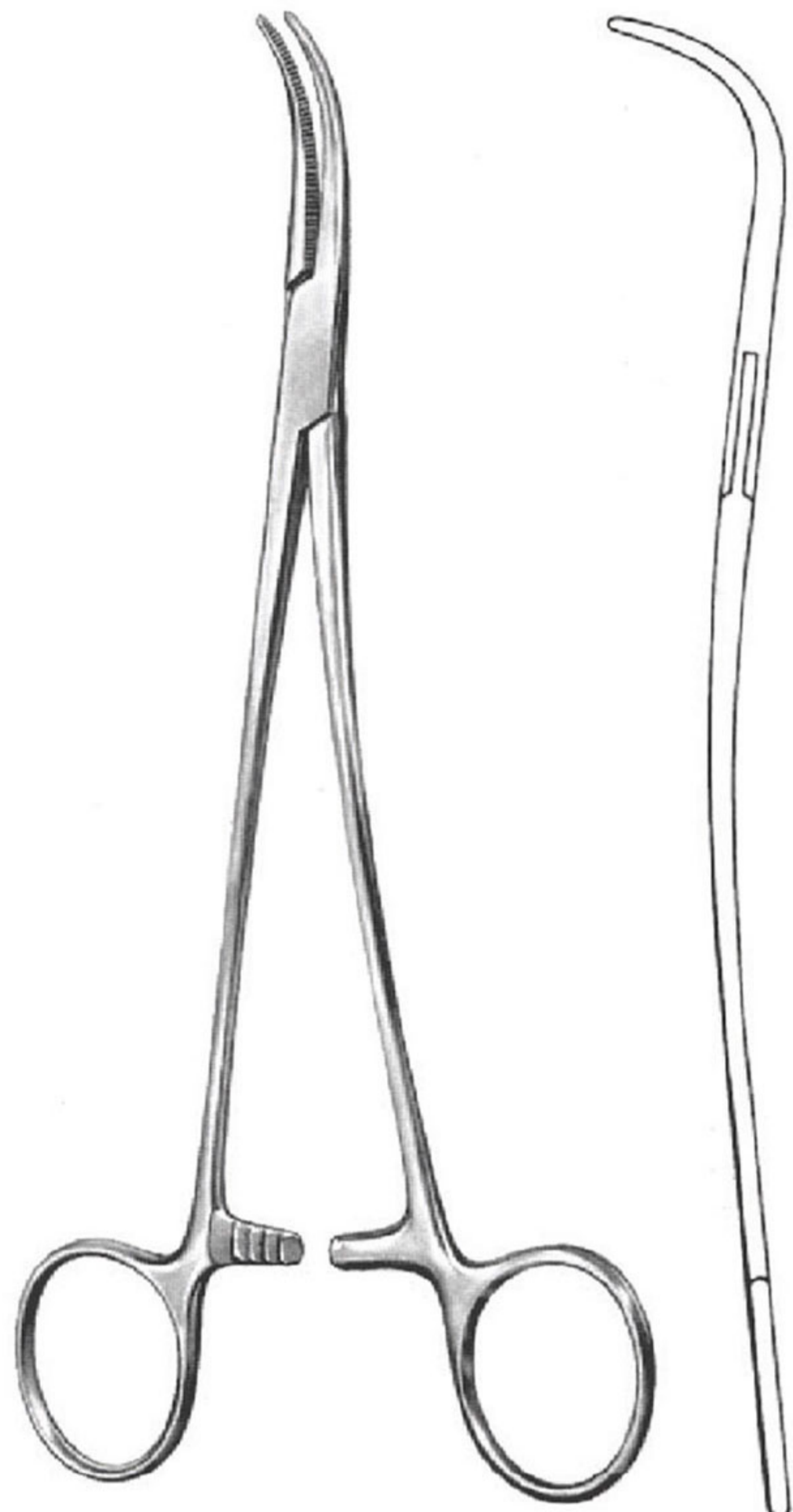
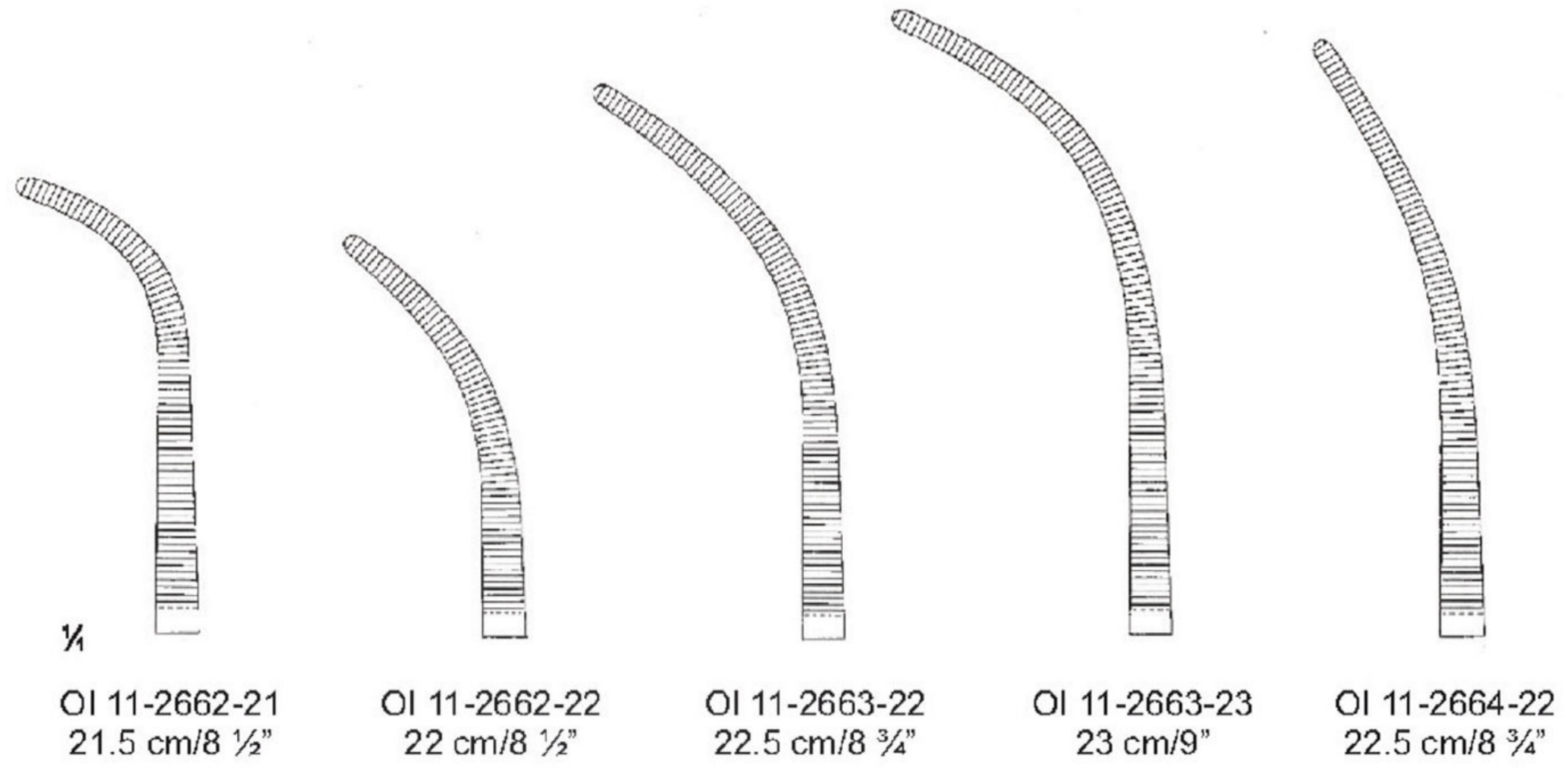

Fig. 1 OI 11-2658-27 27 cm/10 1/2"	Fig. 2 OI 11-2658-26 26.5 cm/10 3/8"	Fig. 3 OI 11-2659-27 27.5 cm/10 3/4"	Fig. 4 OI 11-2659-28 28 cm/11"	Fig. 5 OI 11-2660-27 27.5 cm/10 3/4"	Fig. 6 OI 11-2660-28 28 cm/11"	Fig. 7 OI 11-2661-28 27.5 cm/10 3/4"
--	--	--	--------------------------------------	--	--------------------------------------	--

ARTERY FORCEPS



OVERHOLT-FINO



OVERHOLT-SLIM

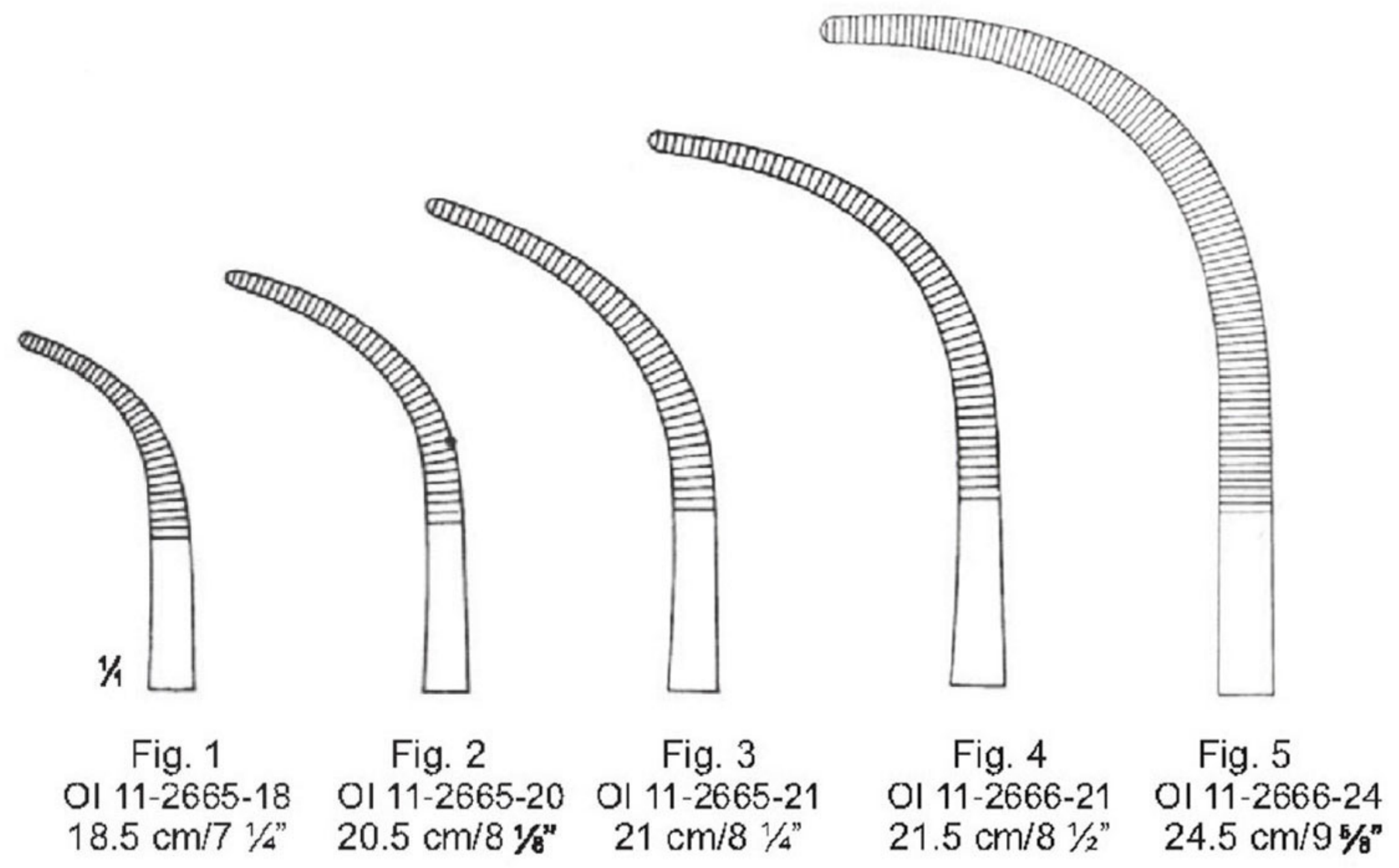

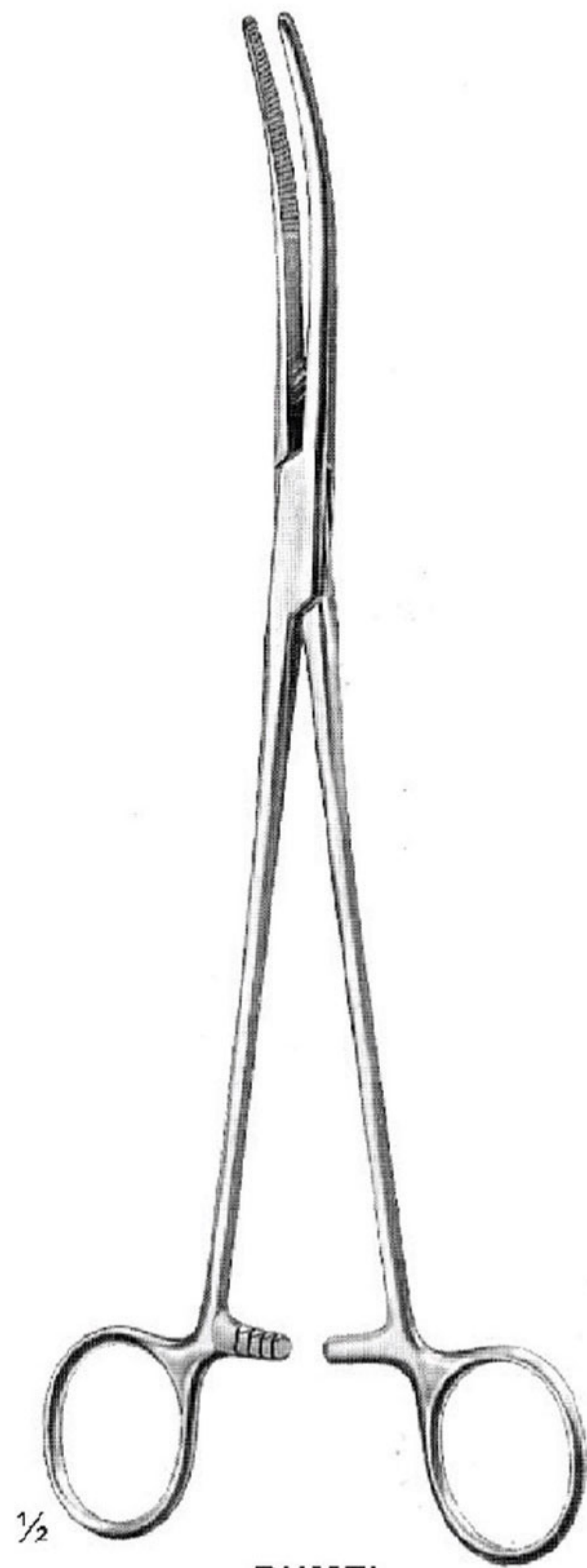

RUMEL
23 cm/9"

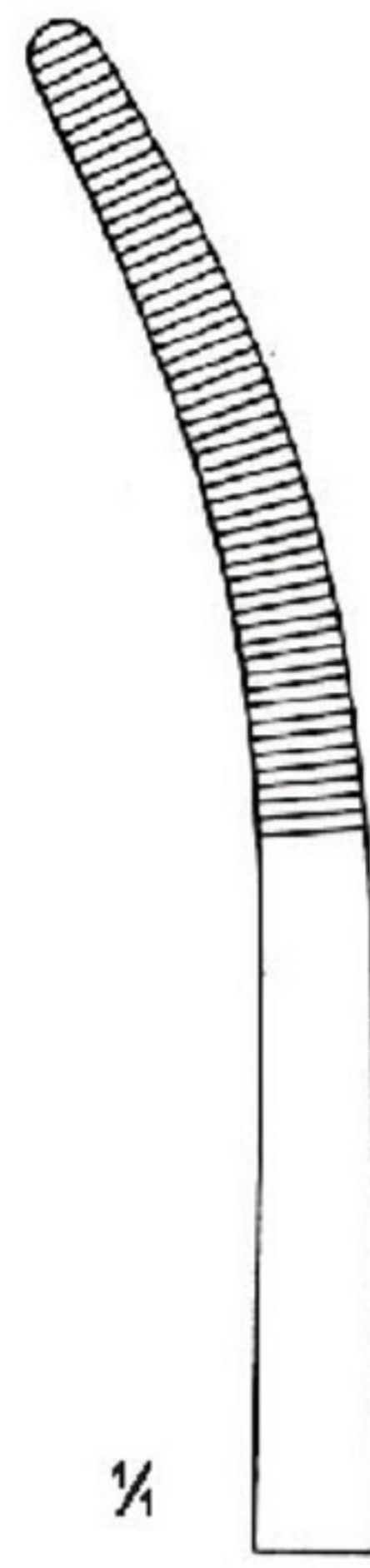

OI 11-2667-23

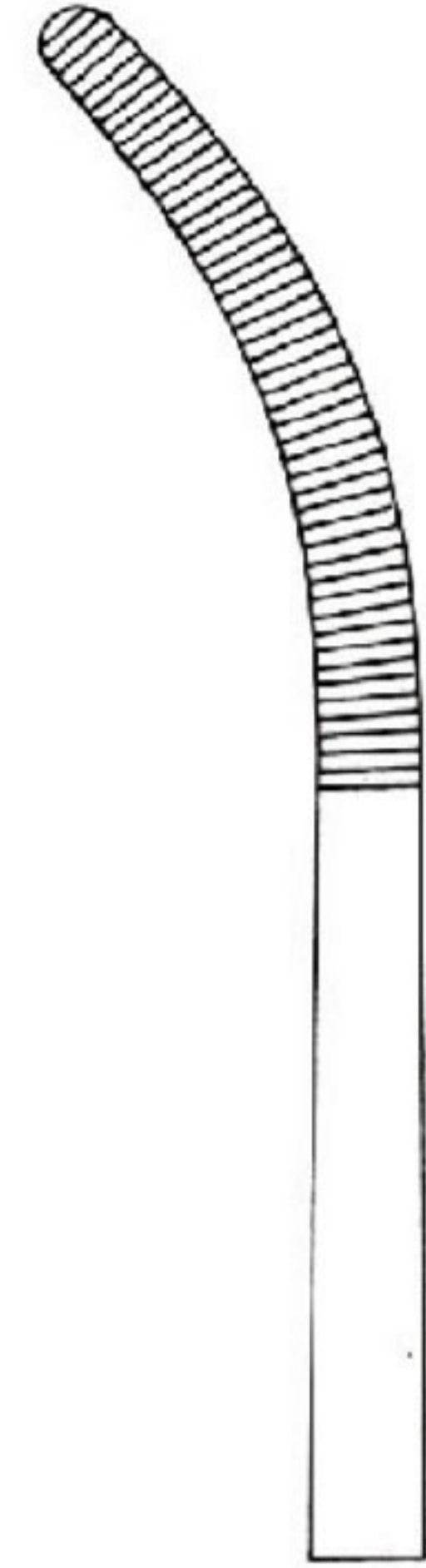

OI 11-2668-23

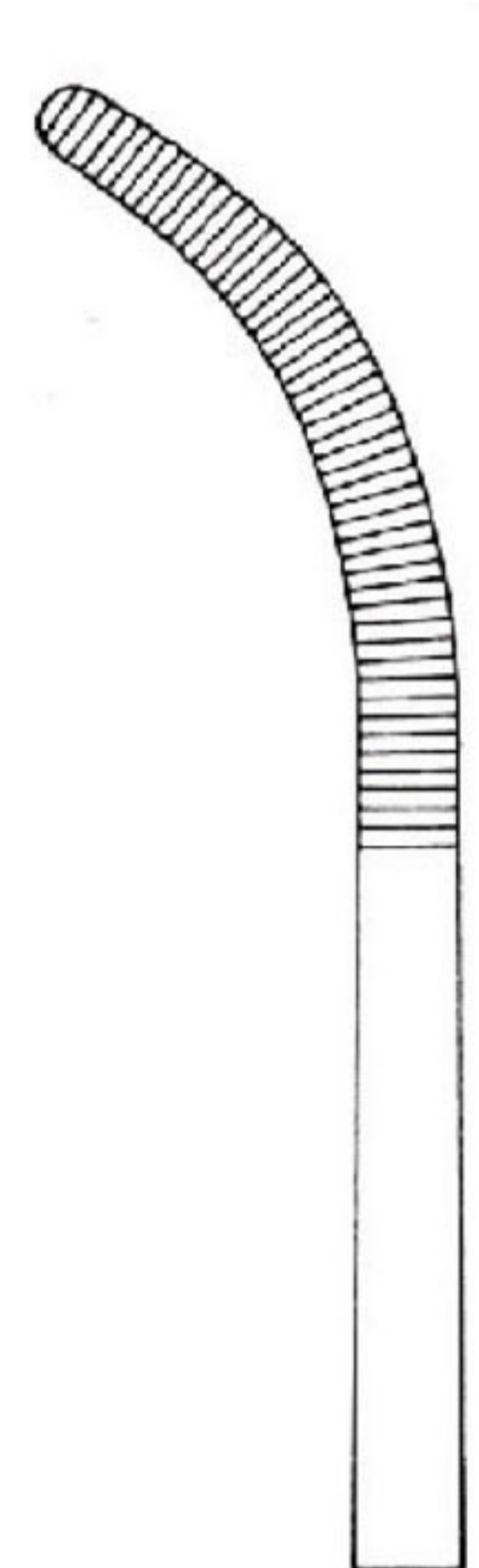

OI 11-2669-23

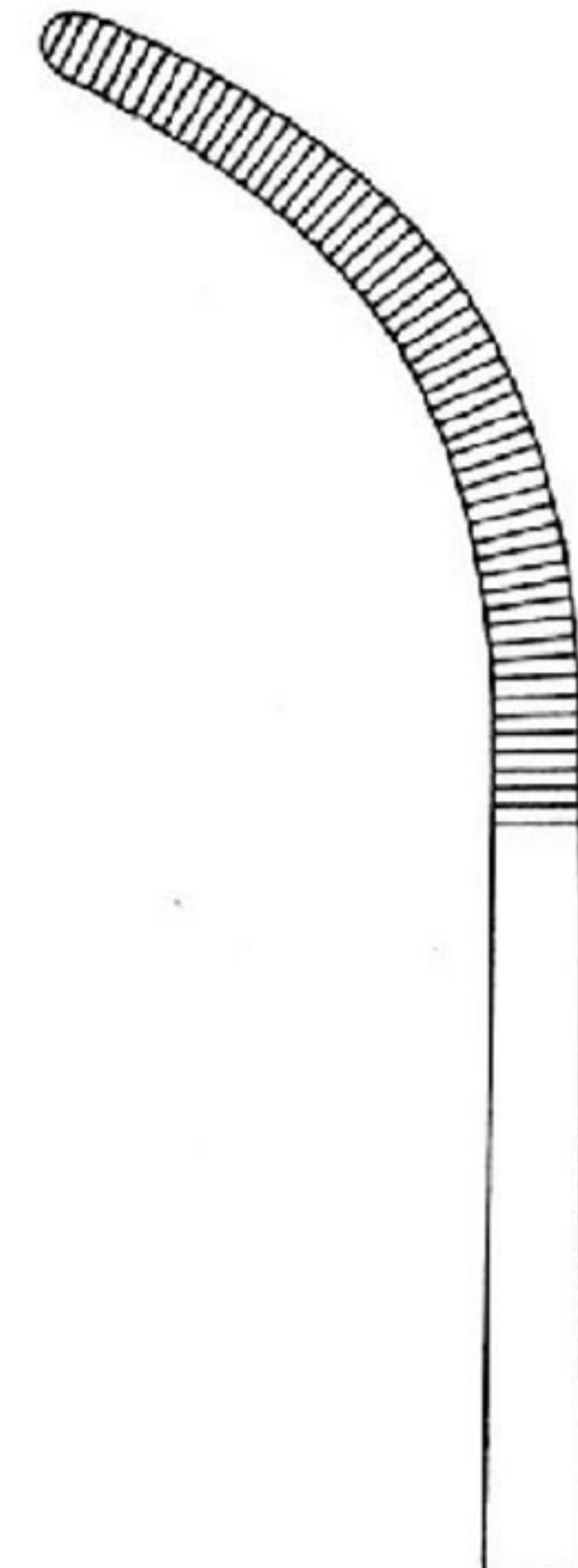

OI 11-2670-23



OI 11-2671-23

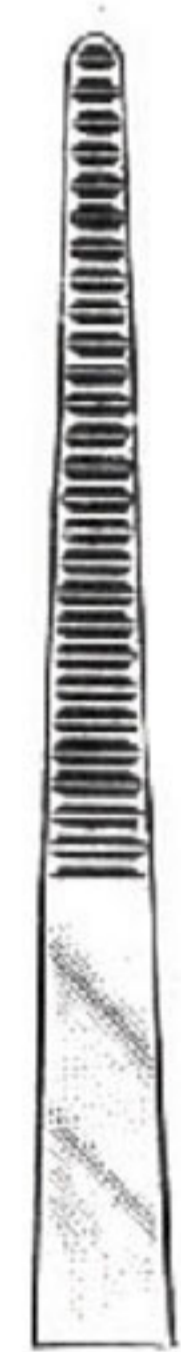
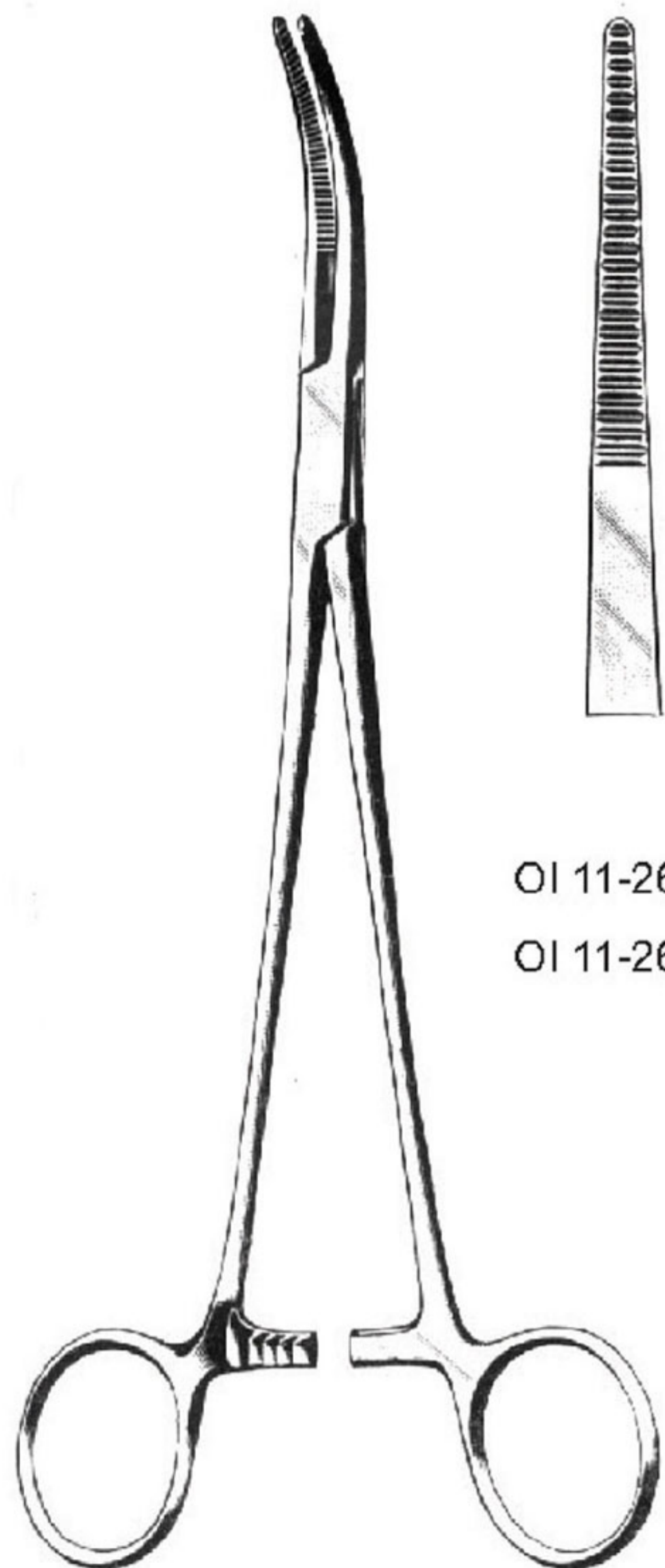

TOENNIS

OI 11-2672-21
OI 11-2672-26



OI 11-2673-21 21.0 cm 8 1/4"
OI 11-2673-26 26.0 cm 10 1/4"



TOENNIS

OI 11-2674-21
OI 11-2674-26



1:2

OI 11-2675-21
OI 11-2675-26

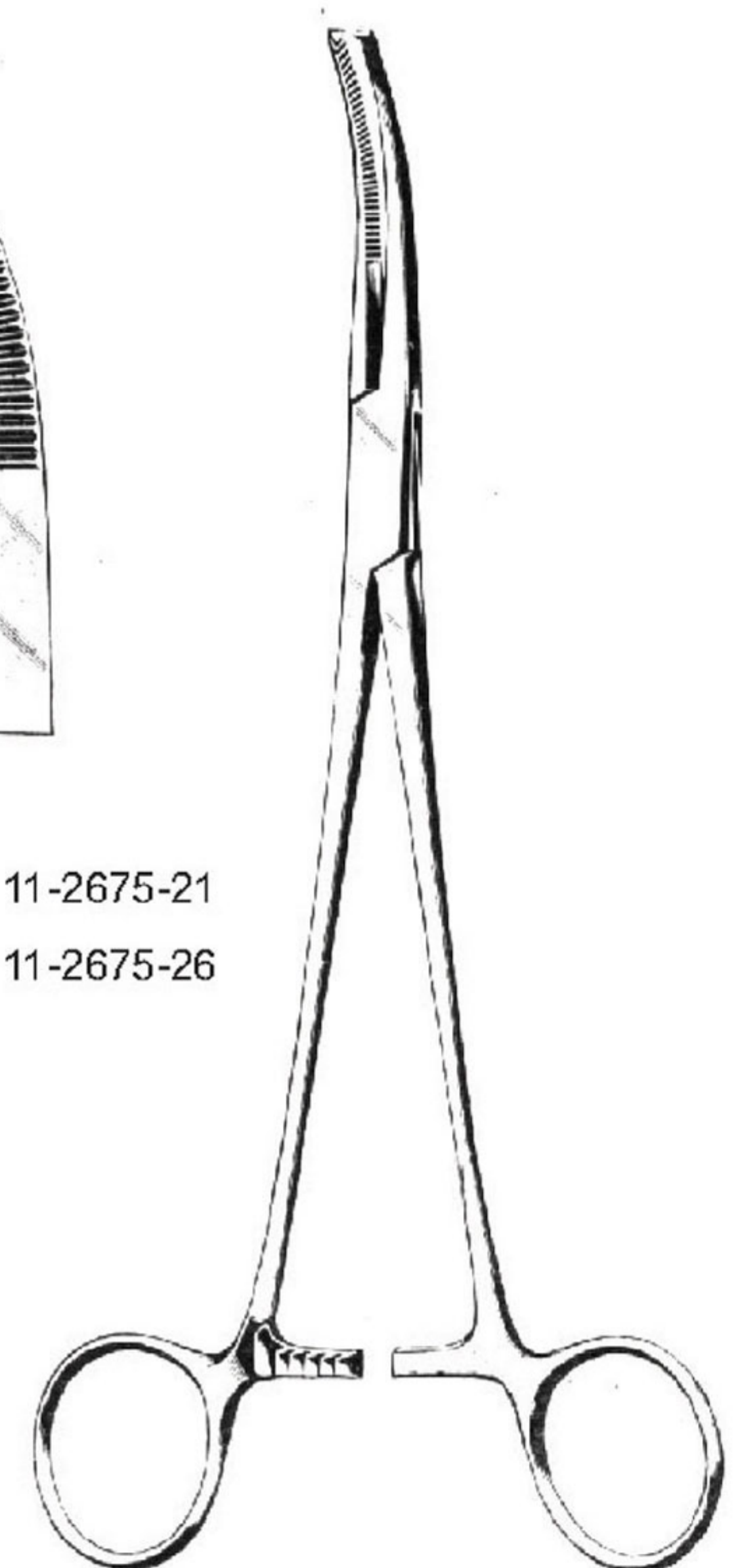

ARTERY FORCEPS

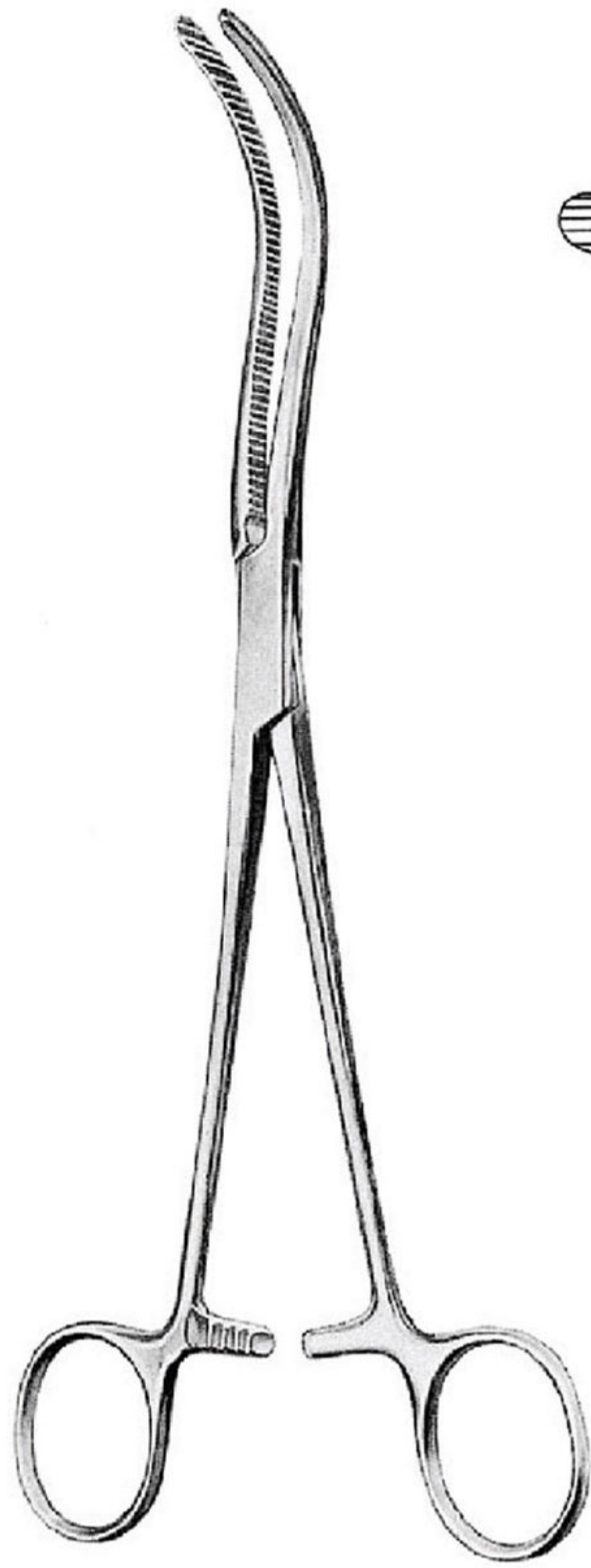

GUYON

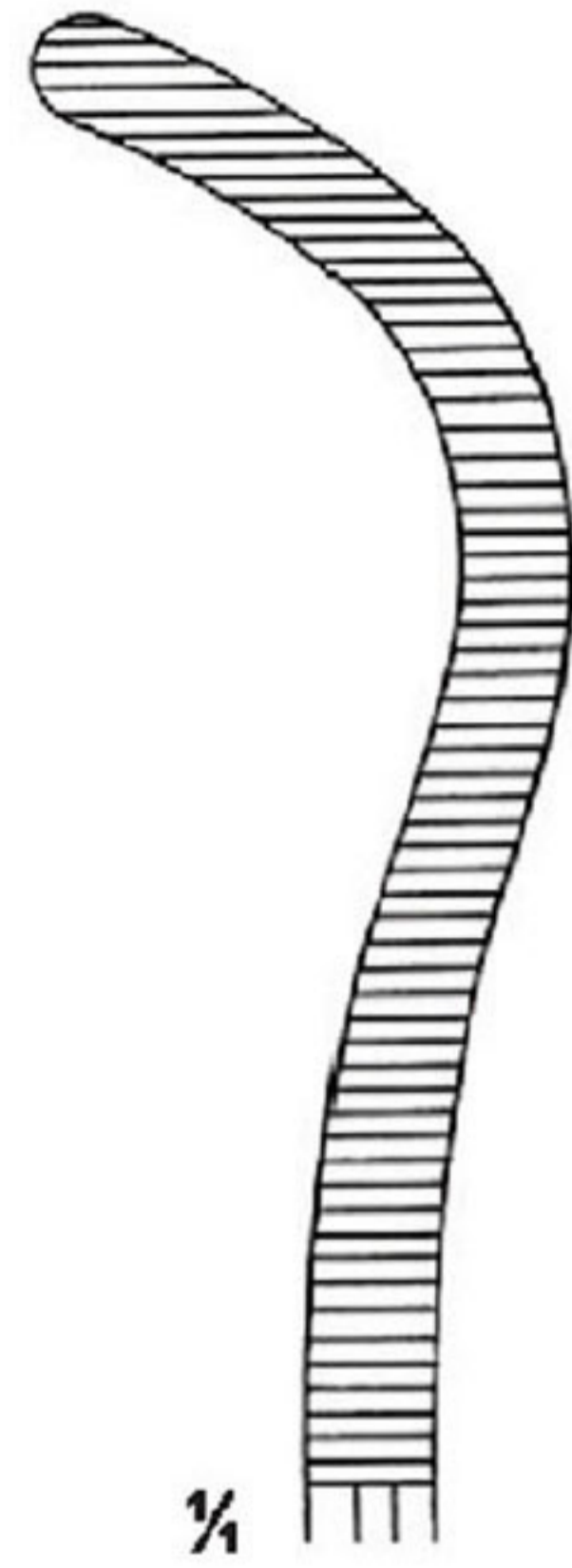

OI 11-2676-20
20 cm/7 7/8"

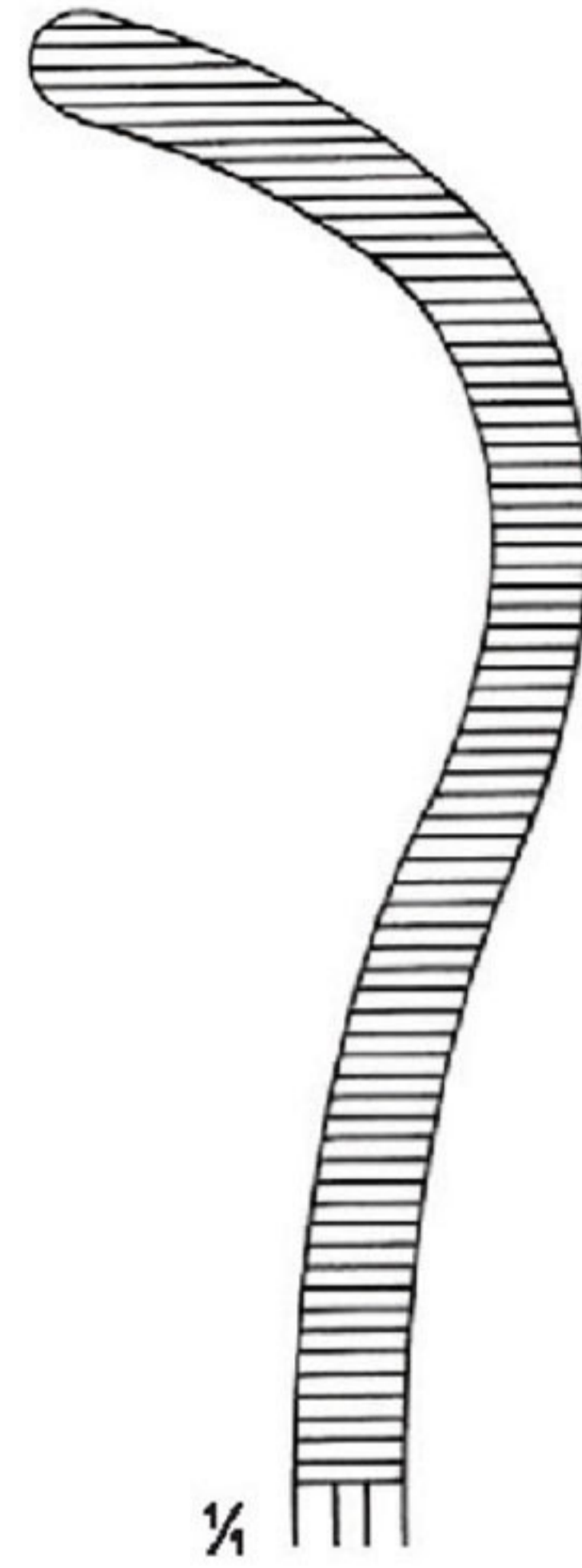

OI 11-2676-22
22 cm/8 1/2"

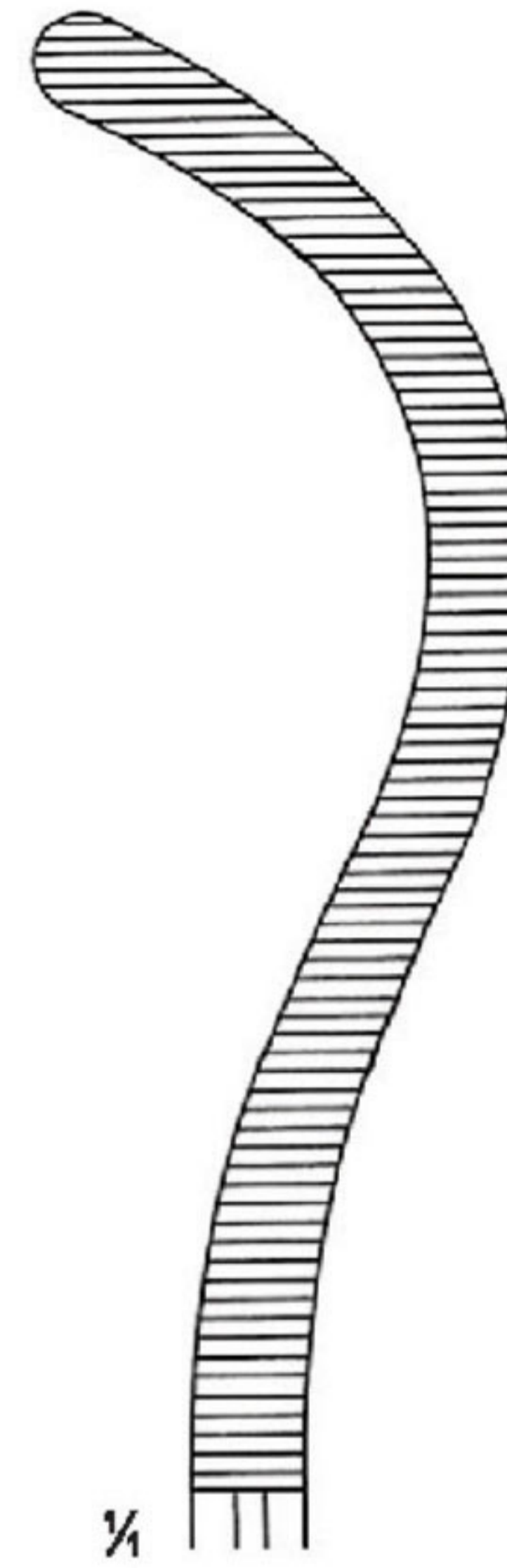

OI 11-2676-24
24 cm/9 1/2"

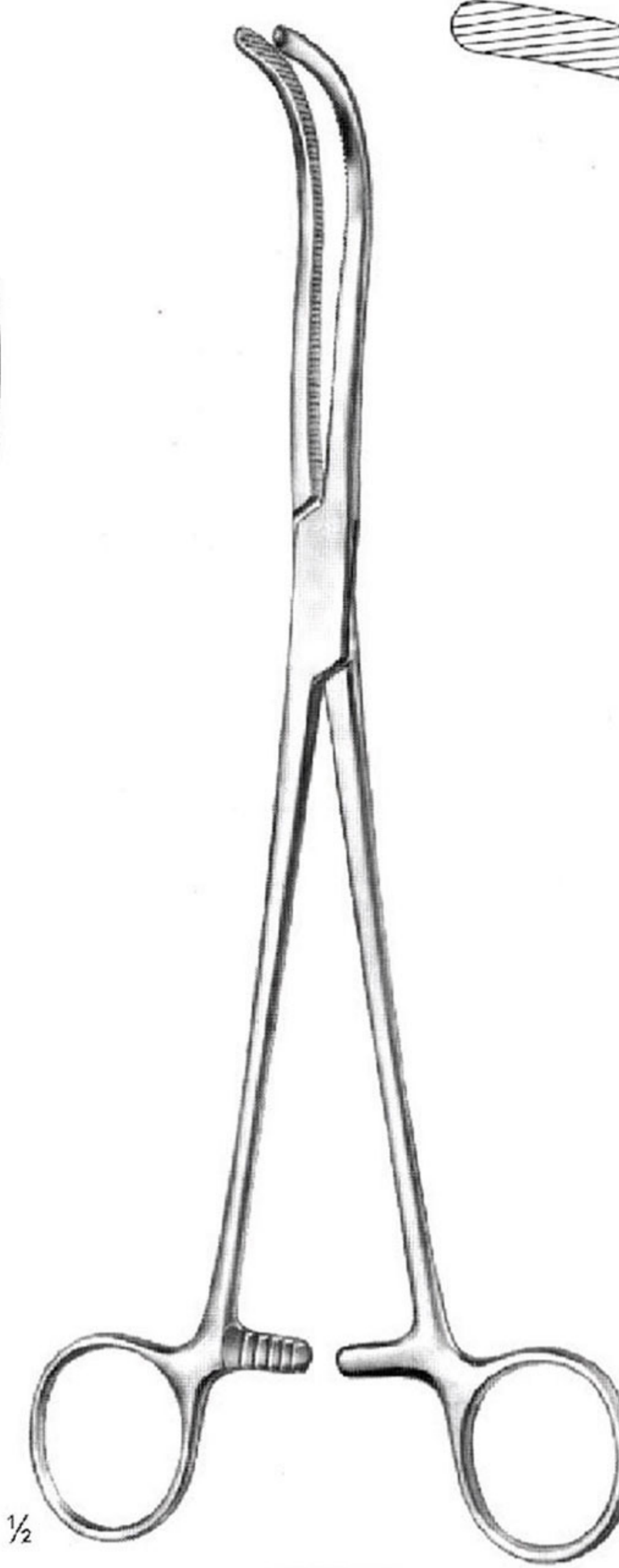

GUYON
OI 11-2677-23
23 cm/9"



**GUYON
ATRAUMA**

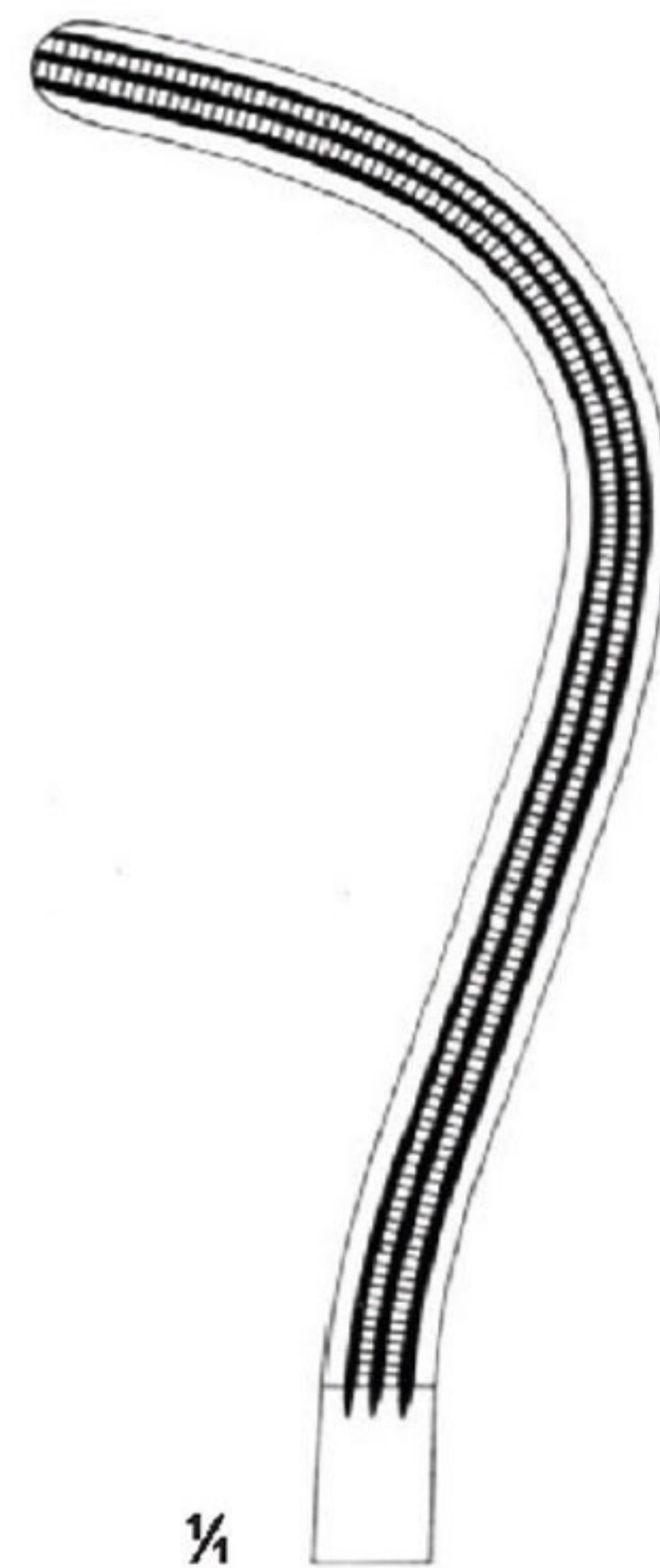

OI 11-2678-23
23 cm/9"

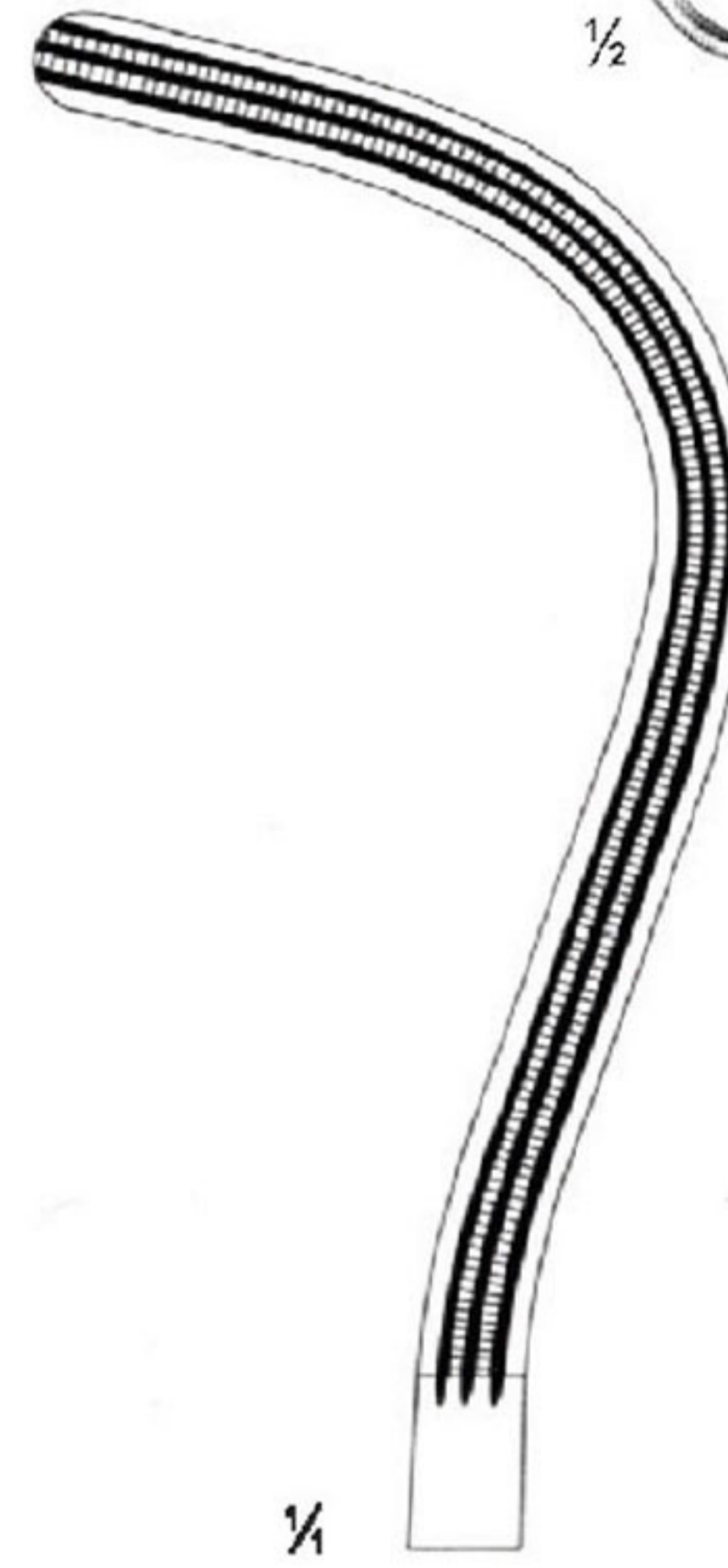

OI 11-2678-24
24 cm/9 1/2"

ATRAUMA



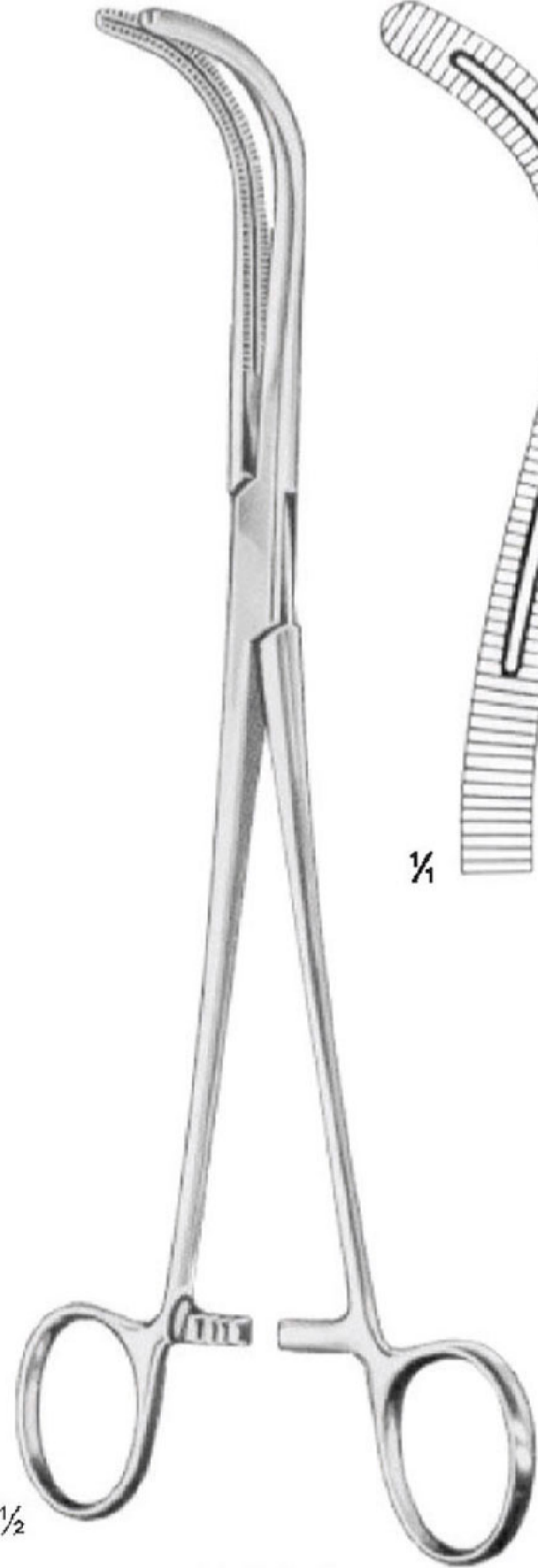

STILLE
OI 11-2679-23
23 cm/9"

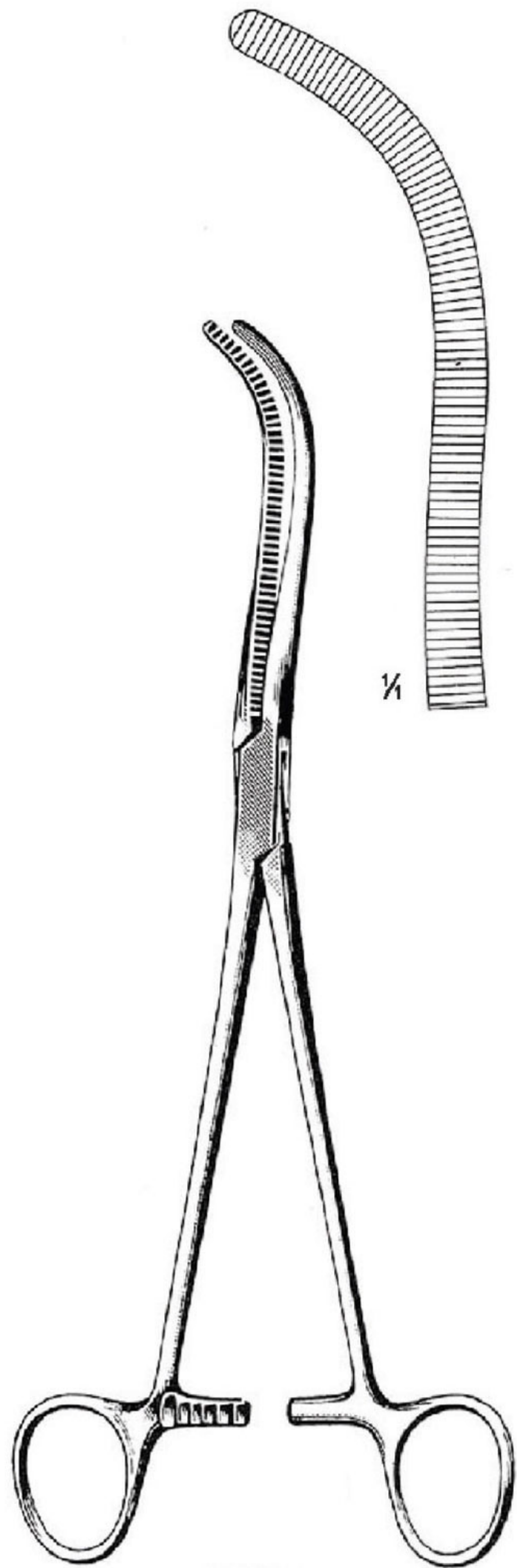

MAYO
OI 11-2680-23
23 cm/9"

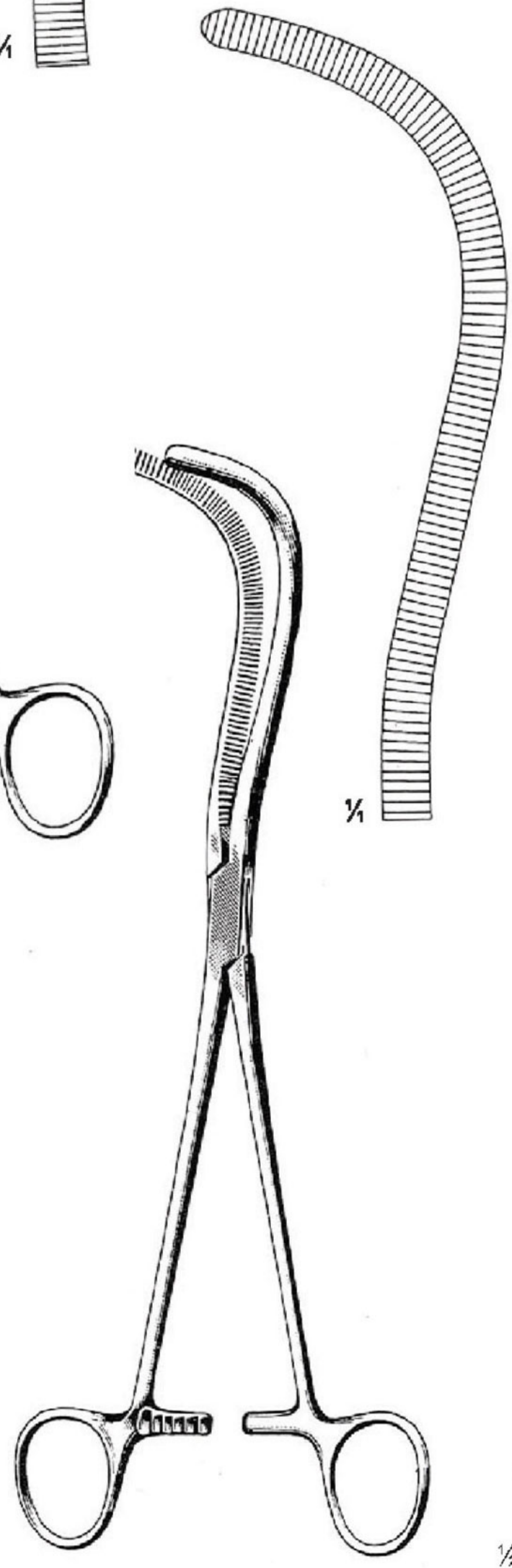

MAYO-GUYON
OI 11-2681-23
23 cm/9"

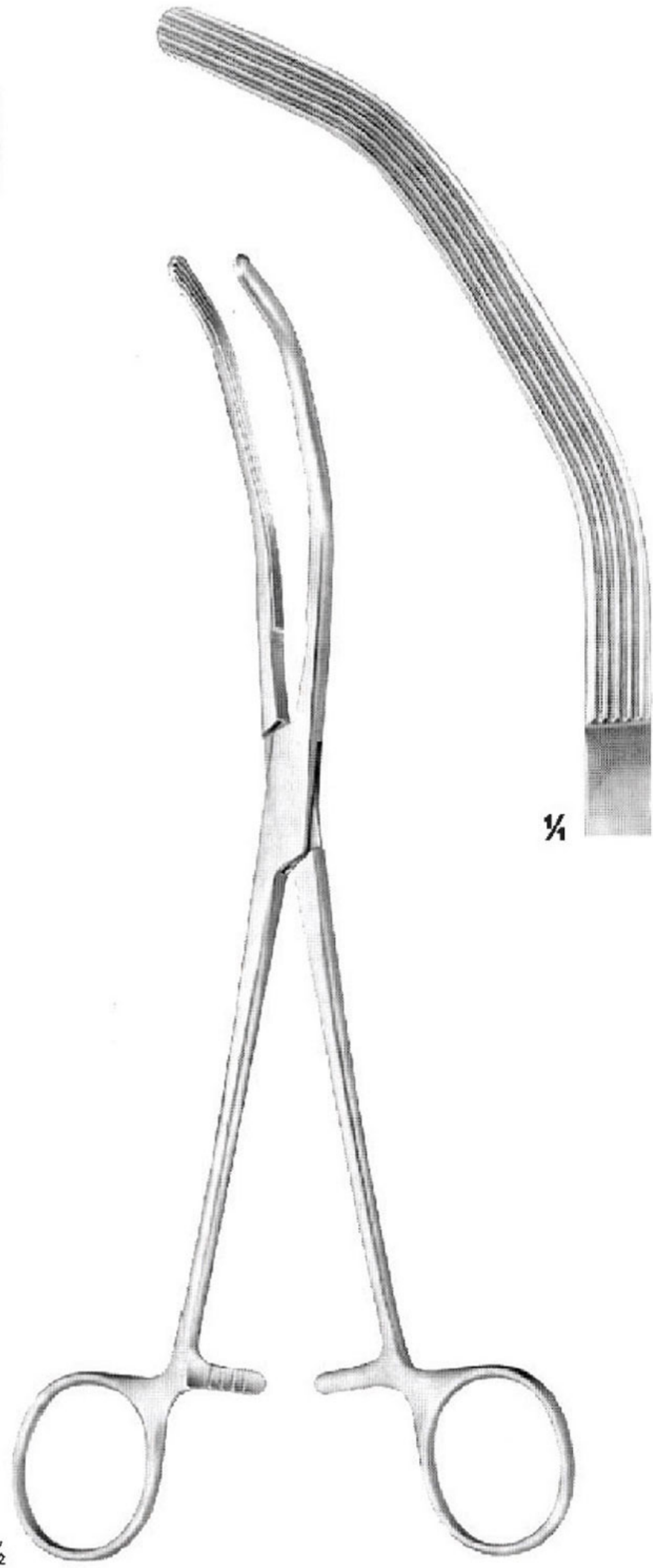

HERRICK
OI 11-2682-23
23 cm/9"

ARTERY FORCEPS

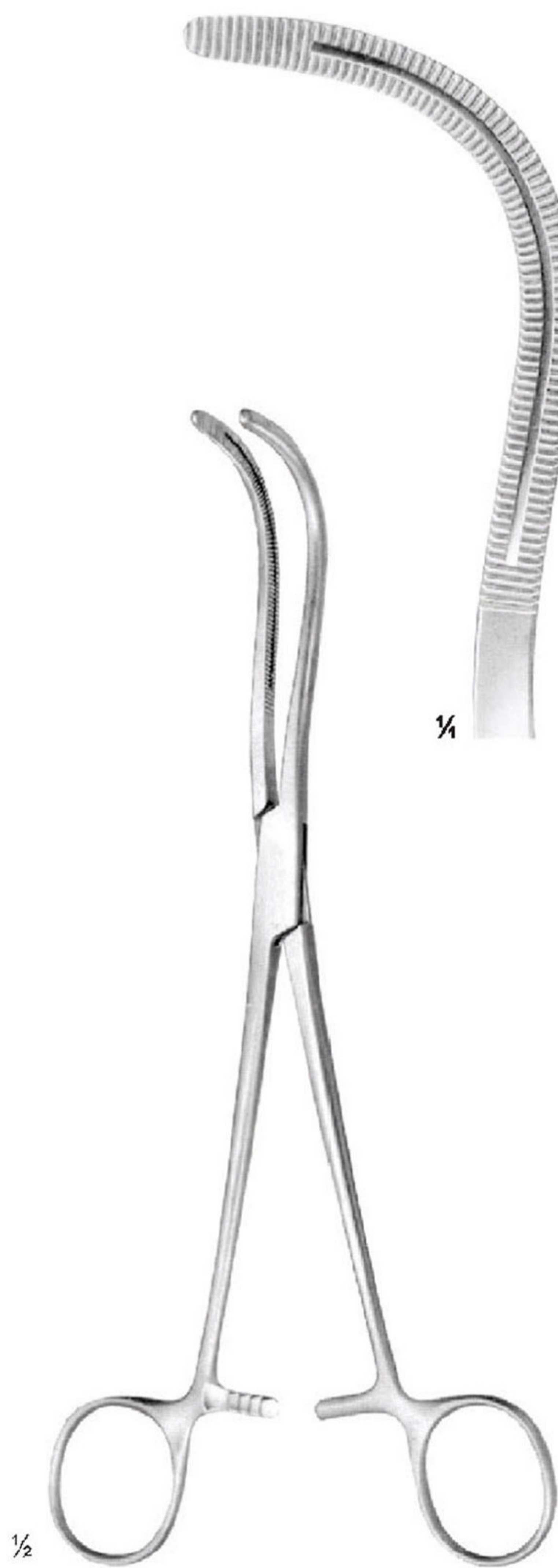

STILLE
OI 11-2683-22
22 cm/8 1/2"

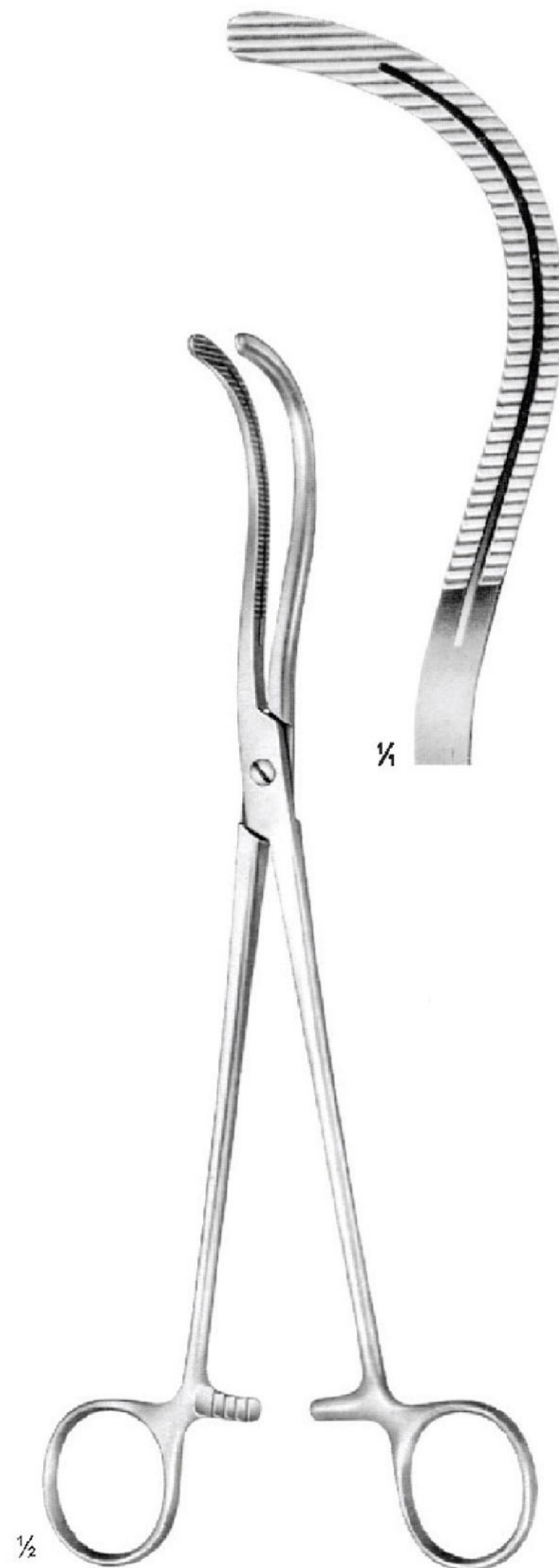

STILLE
OI 11-2684-24
24 cm/9 1/2"
Screw Joint

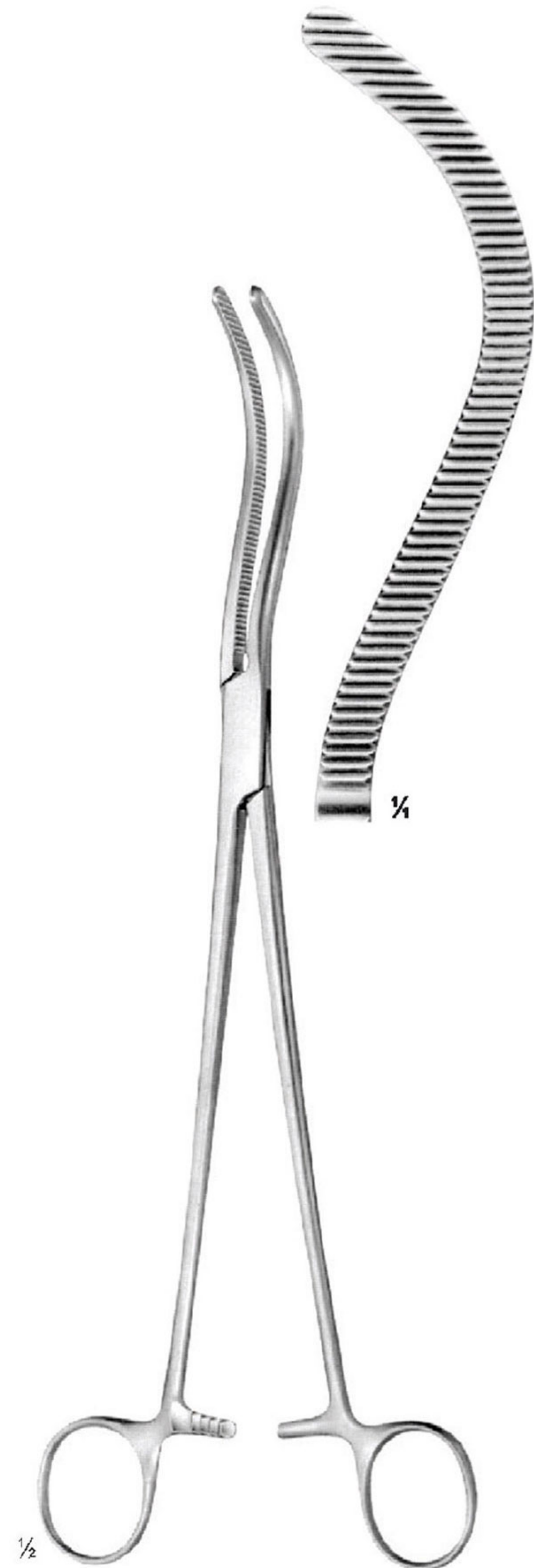

GUYON
OI 11-2685-26
26.5 cm/10 3/8"





GRAY

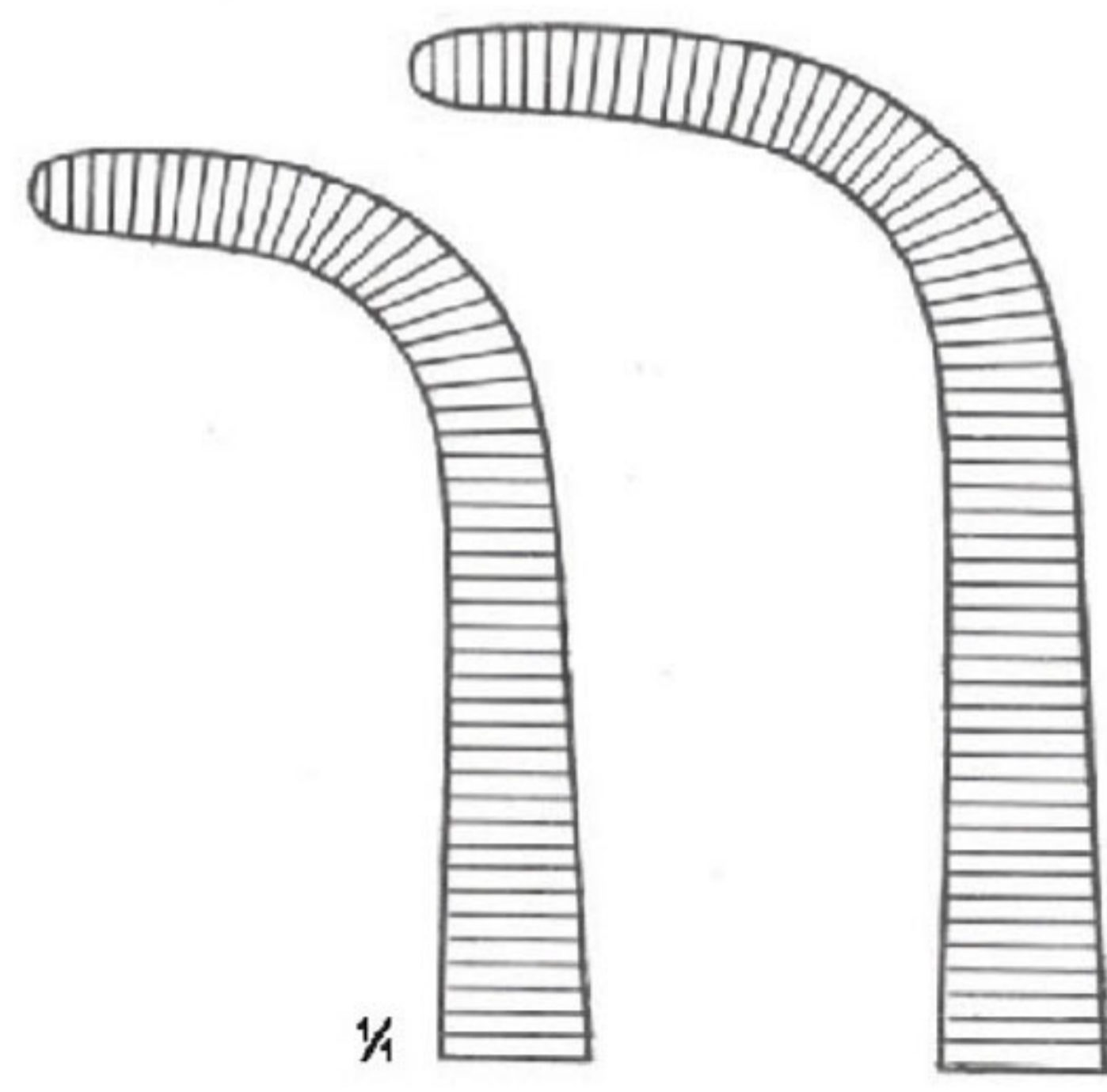
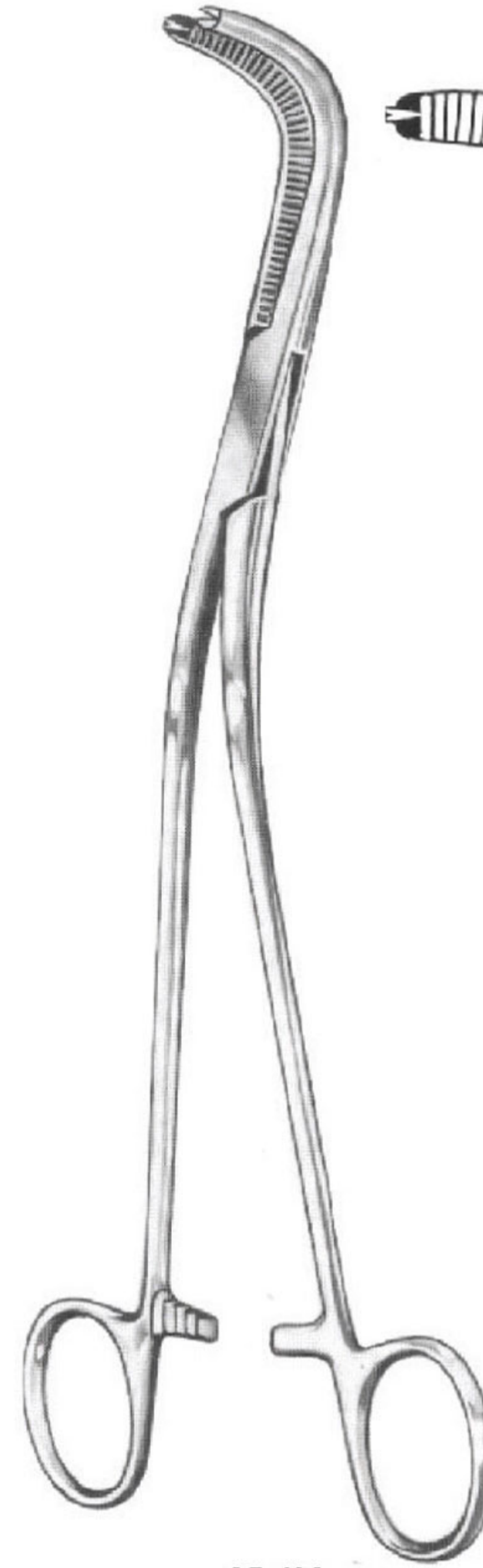

Fig. 1
OI 11-2687-22
22 cm/8 1/2"

2
OI 11-2687-23
23 cm/9"



**GRAY
1:2**

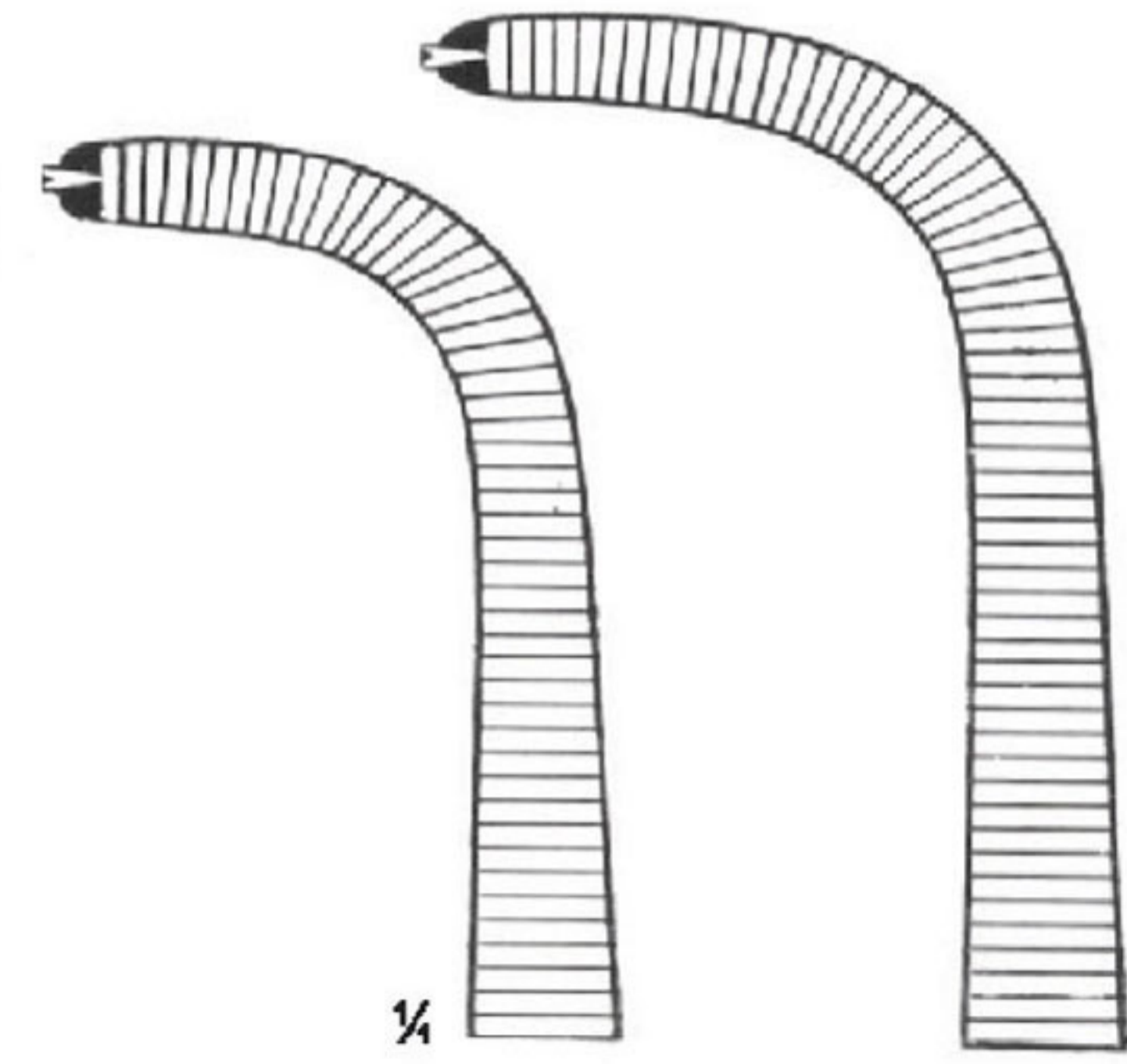
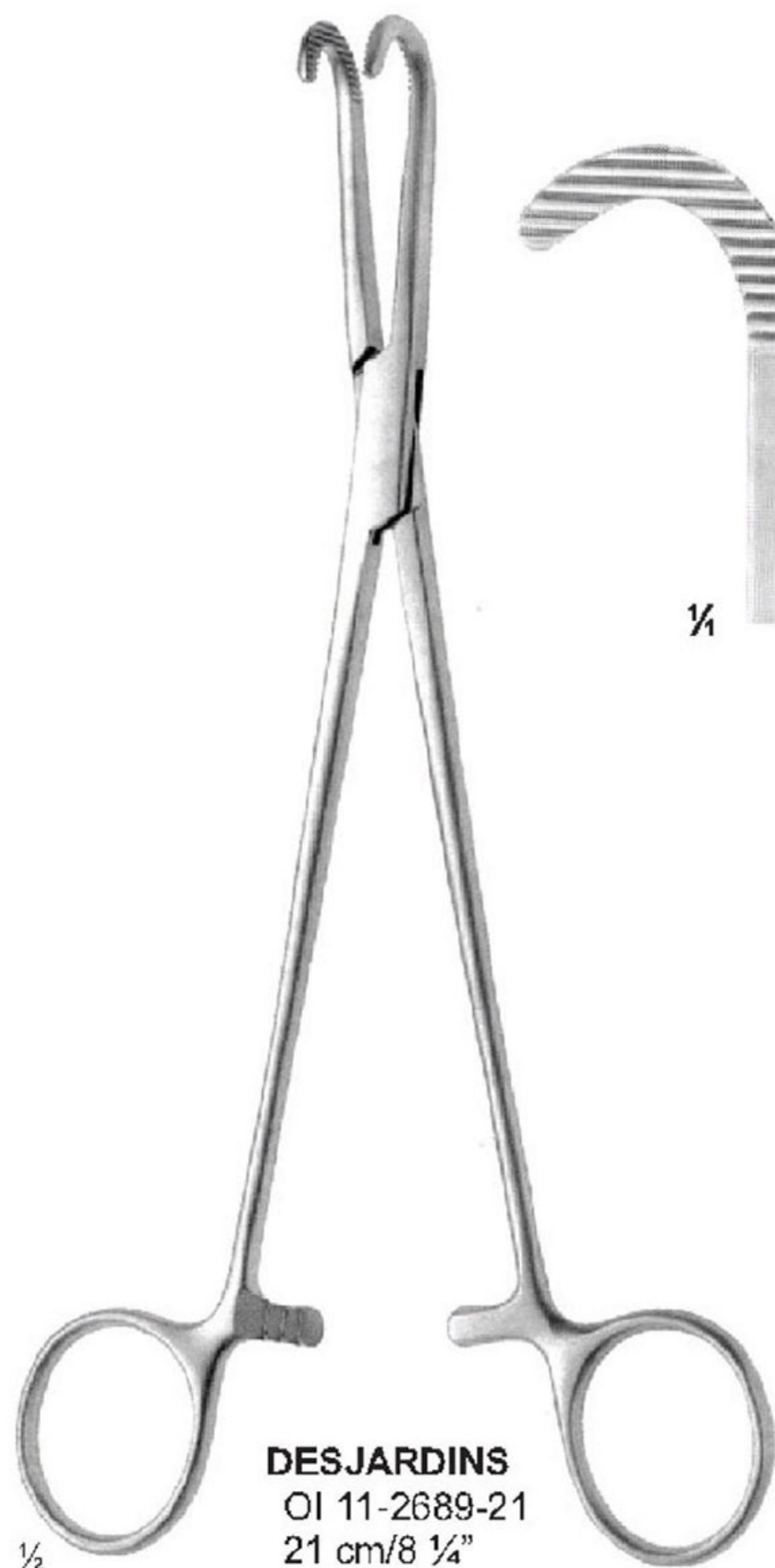
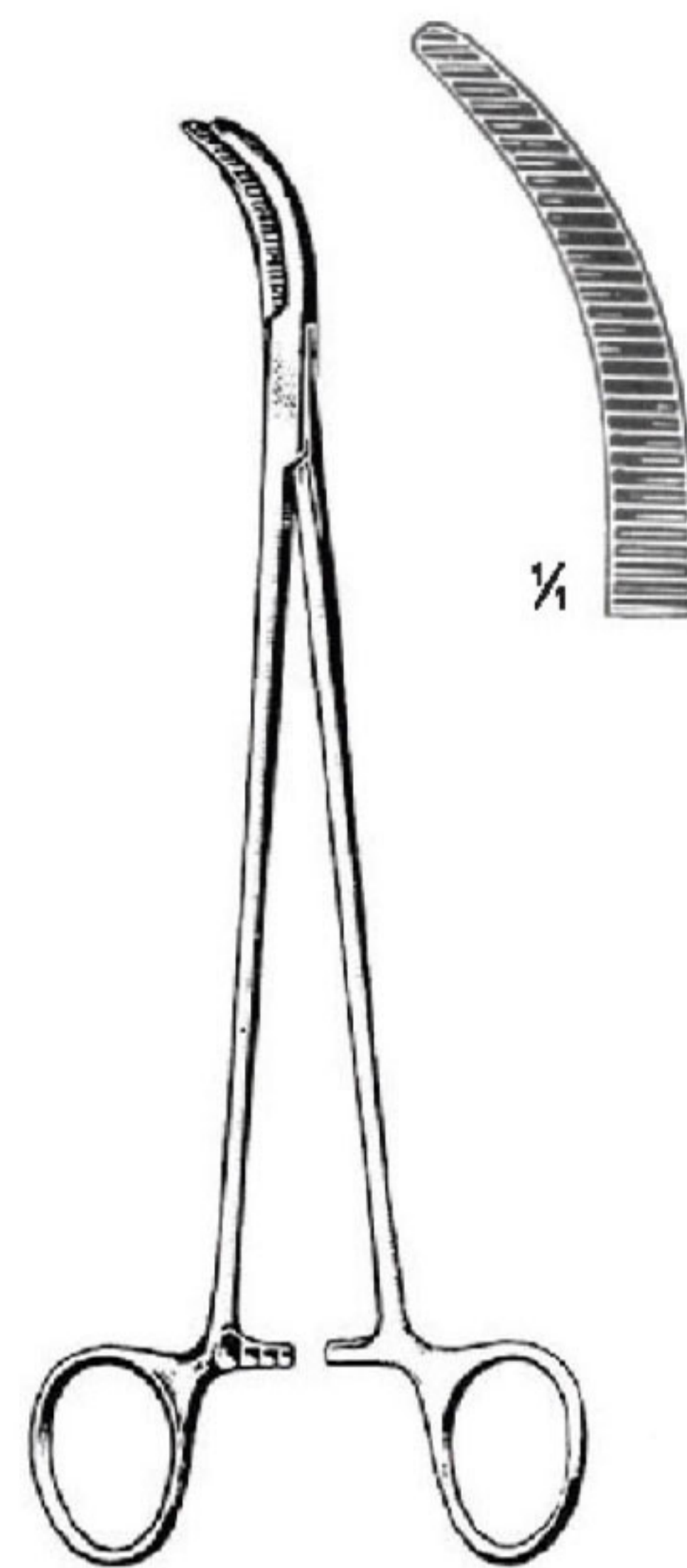
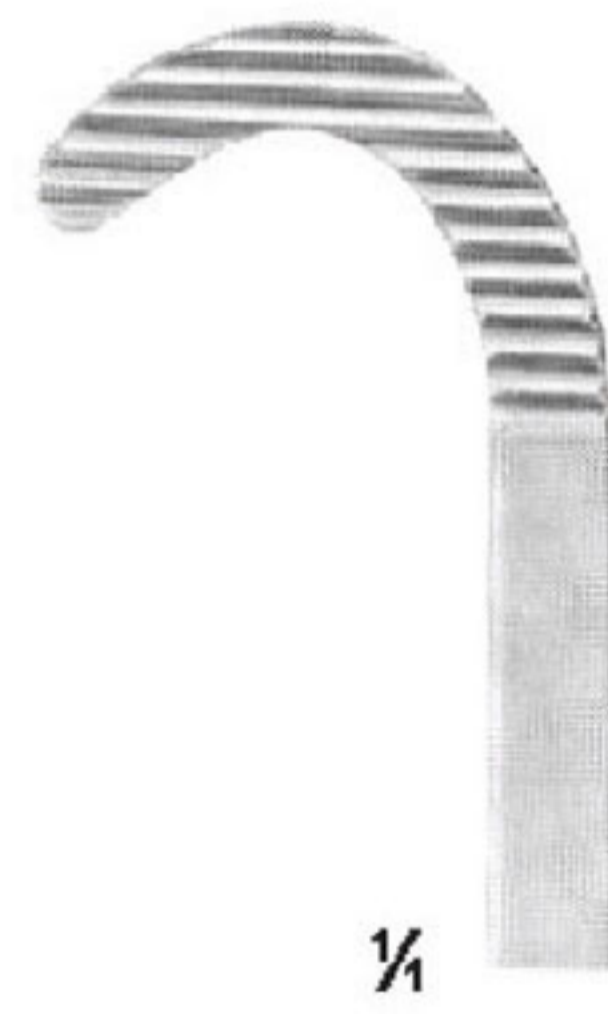

Fig. 1
OI 11-2688-22
22 cm/8 1/2"

2
OI 11-2688-23
23 cm/9"



DESJARDINS
OI 11-2689-21
21 cm/8 1/4"



DESJARDINS
OI 11-2690-21
21 cm/8 1/4"

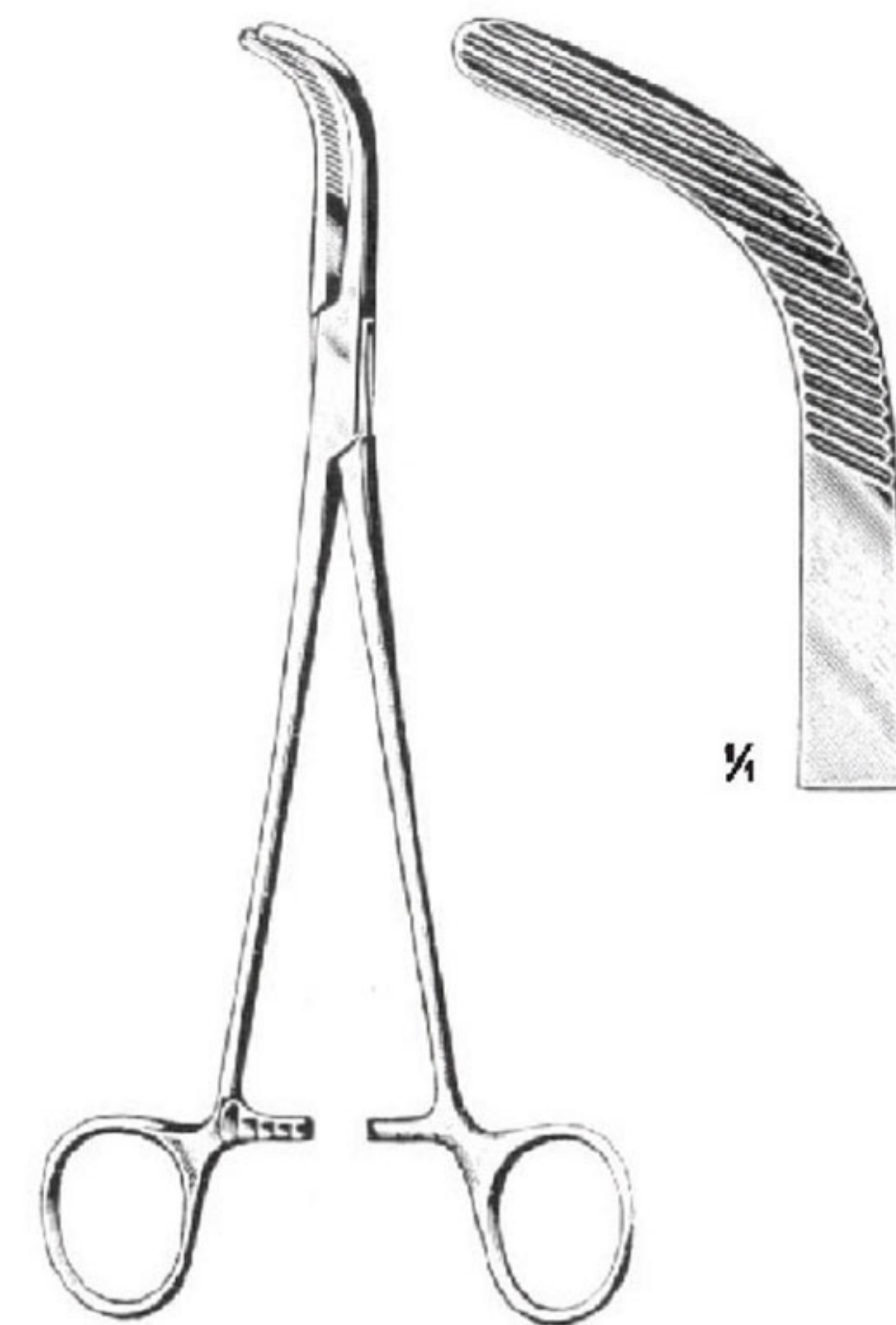

CRILE
OI 11-2691-20
20 cm/7 7/8"



ARTERY FORCEPS

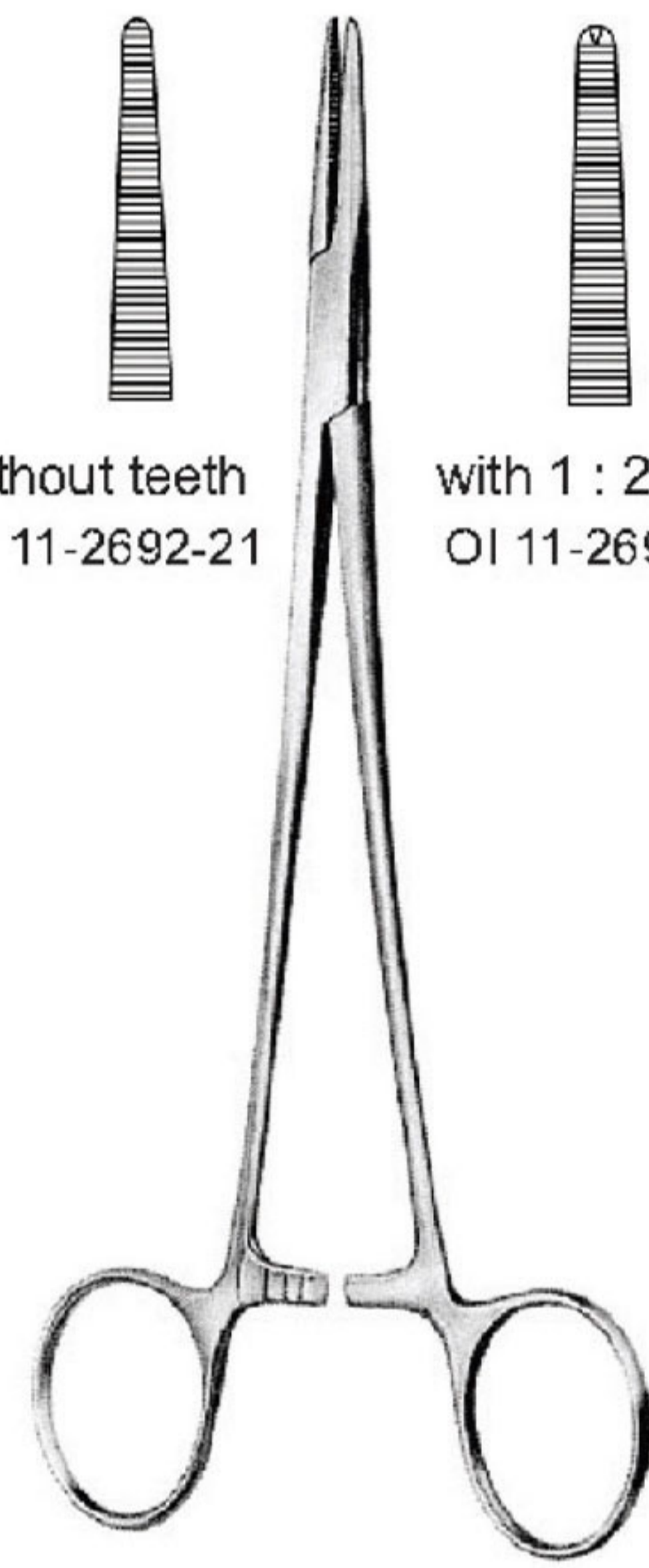
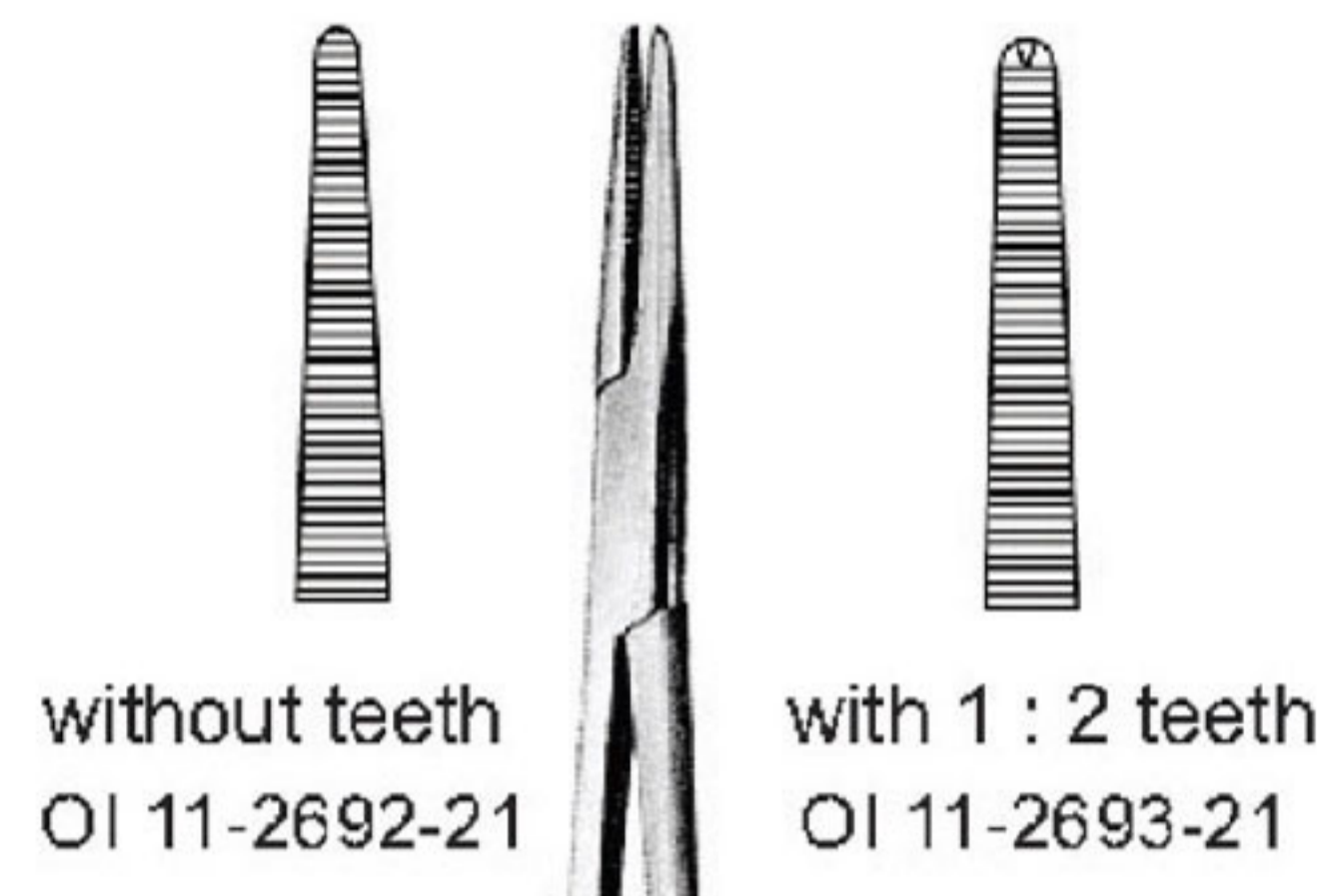

HOSEMANN
21 cm/8 1/4"



1/2

NEGUS
19 cm/7 1/2"

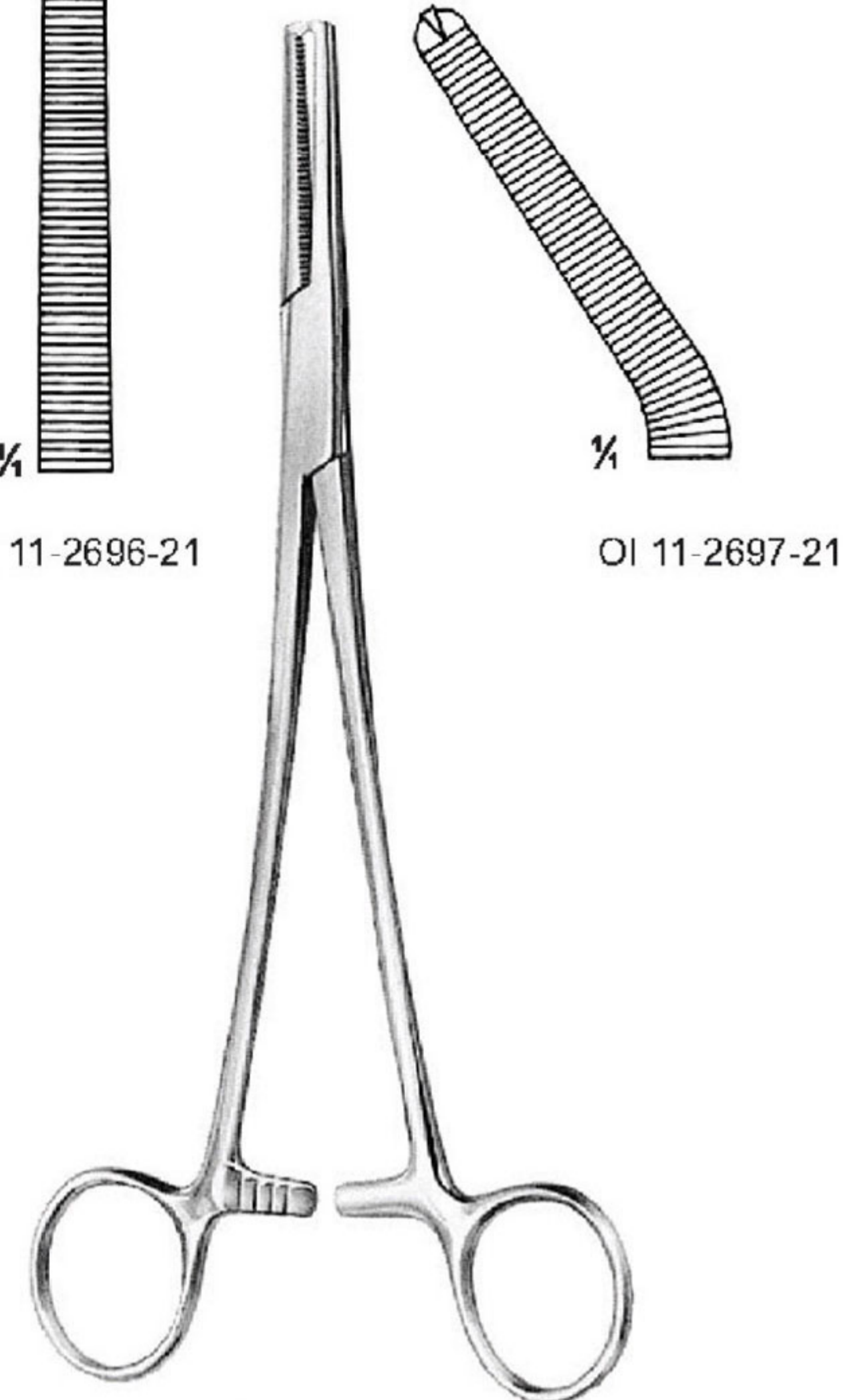
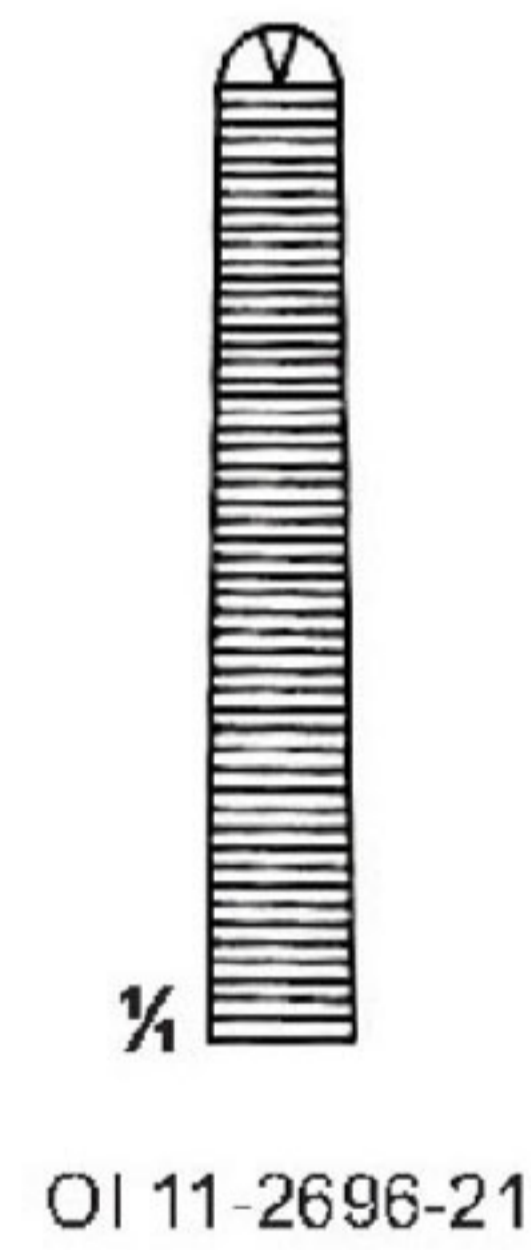
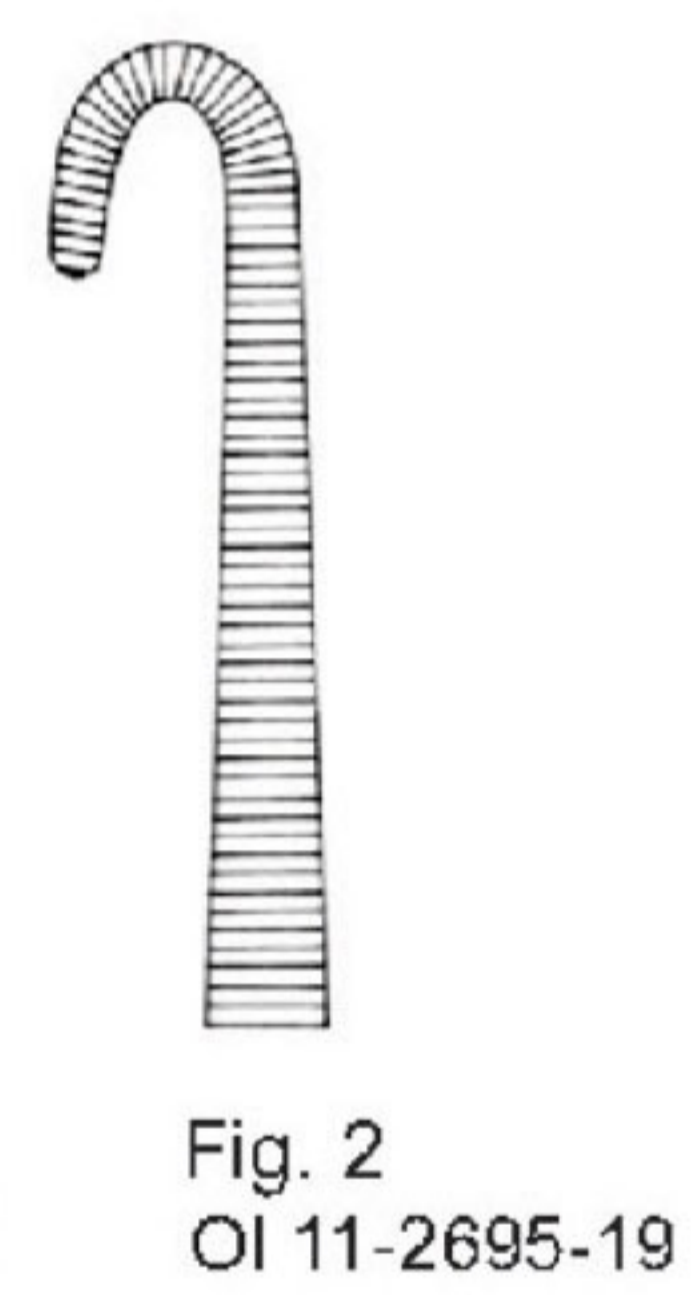
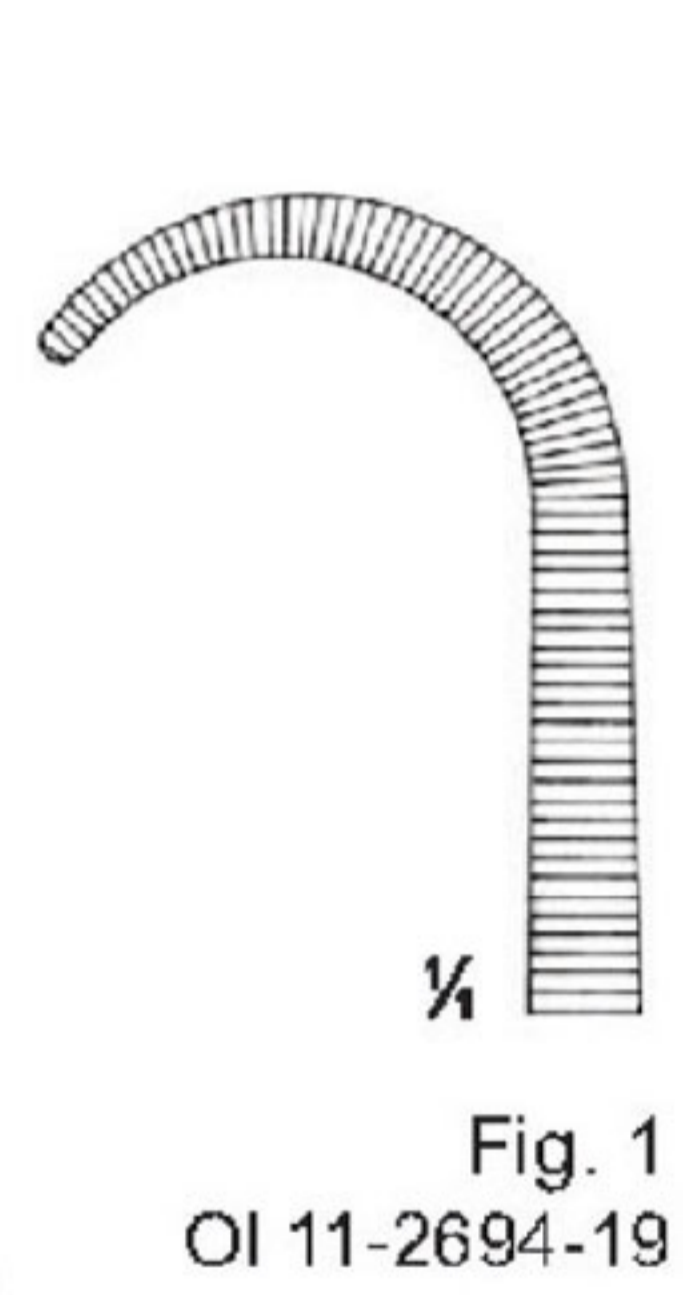

PHANEUF
21.5 cm/8 1/2"
1 : 2

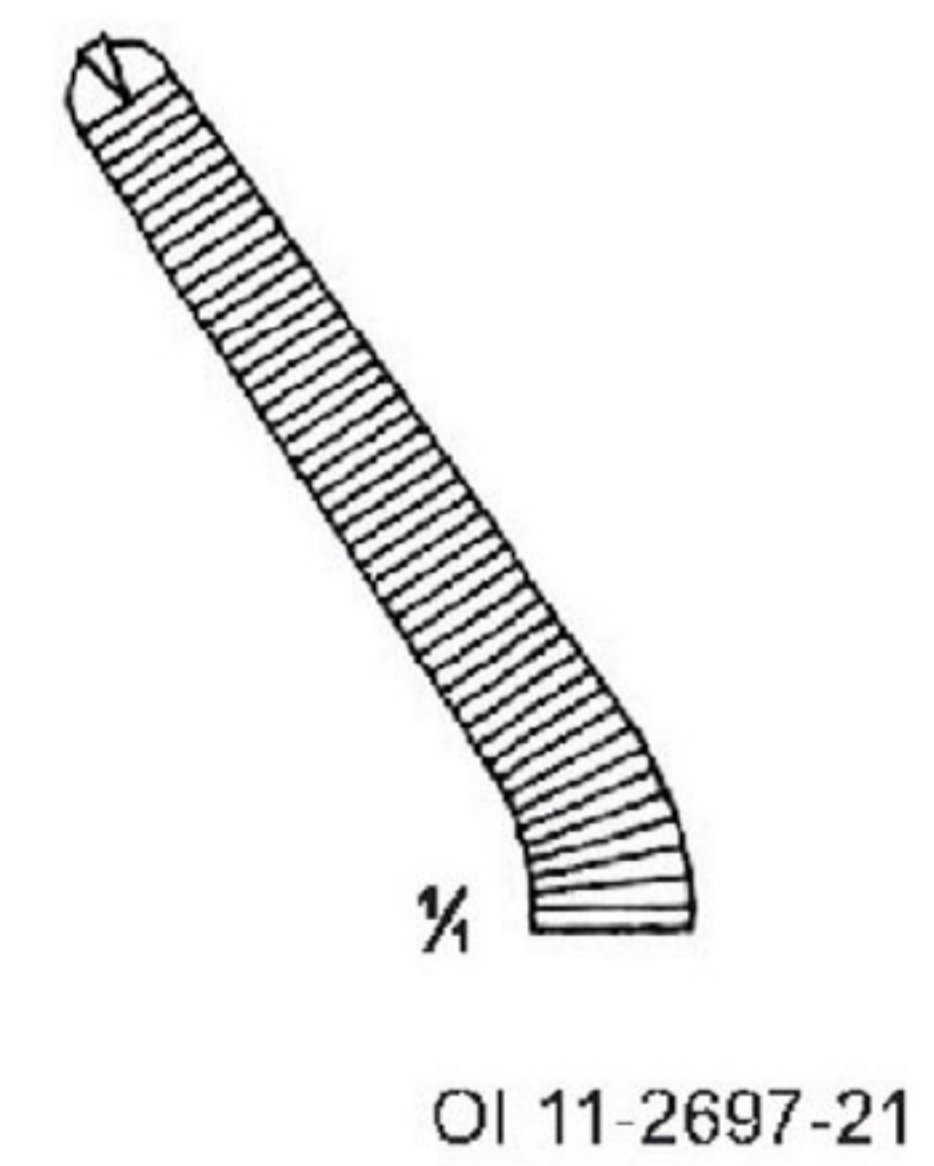

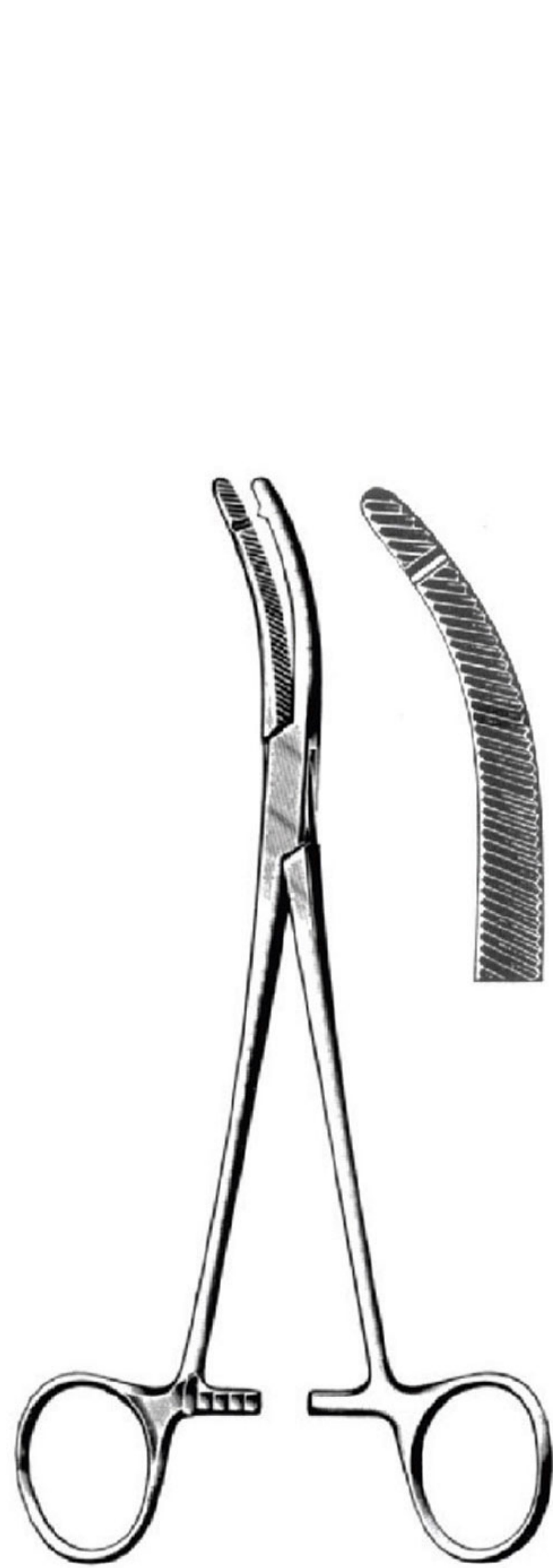

1 Tooth	HEANEY	2 Teeth
OI 11-2698-19	19.5 cm/7 1/2"	OI 11-2699-19
OI 11-2698-21	21.0 cm/8 1/4"	OI 11-2699-21
OI 11-2698-23	23.0 cm/9"	OI 11-2699-23

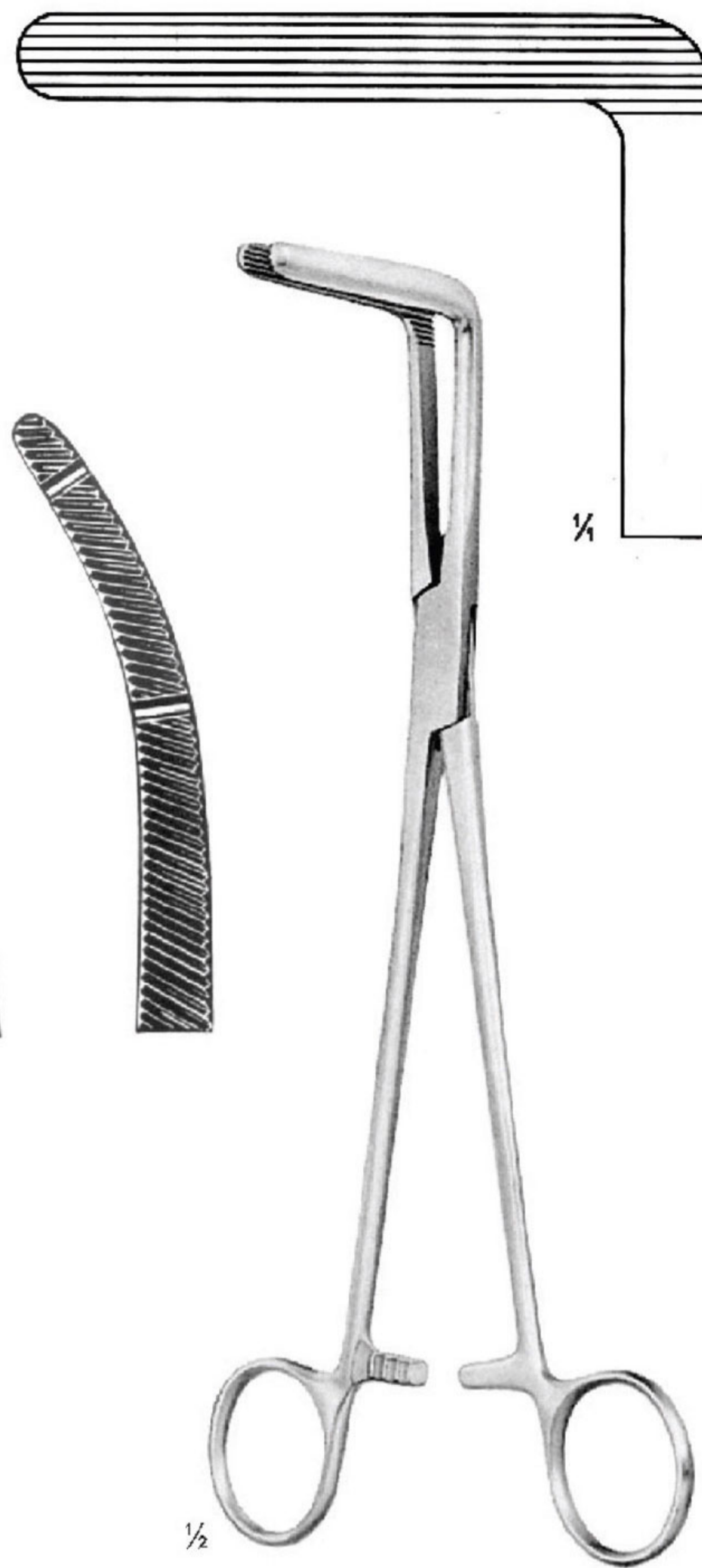

WERTHEIM-CULLEN
OI 11-2700-21
21.5 cm/8 1/2"

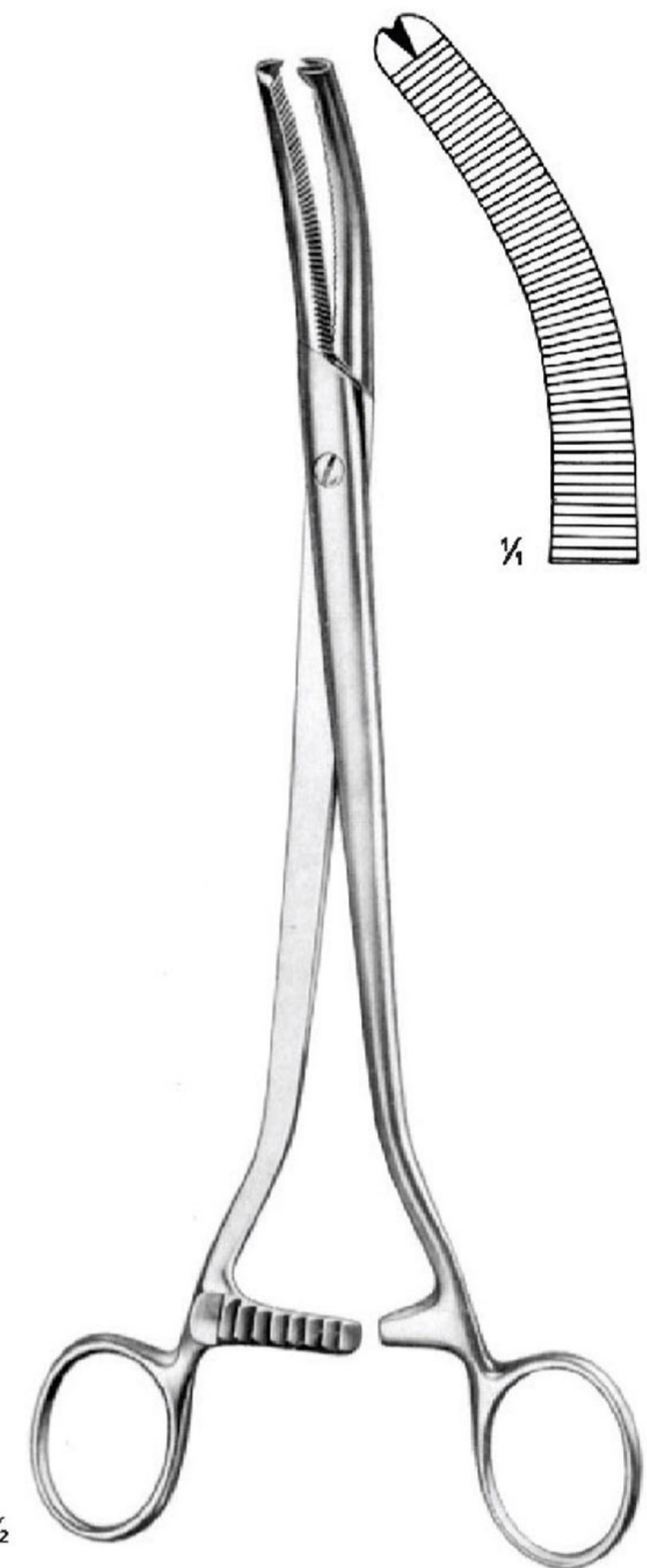

WERTHEIM
OI 11-2701-24
24 cm/9 1/2"
Extra Strong

ARTERY FORCEPS



ROGERS

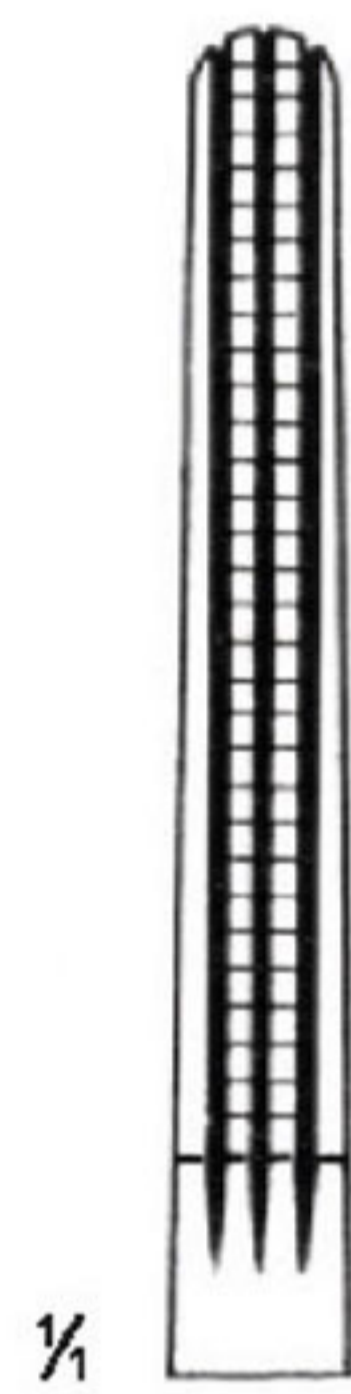

Fig. 1
OI 11-2702-21
21.5 cm/8 1/2"



Fig. 2
OI 11-2703-21
21 cm/8 1/4"



Fig. 3
OI 11-2704-20
20.5 cm/8 1/8"

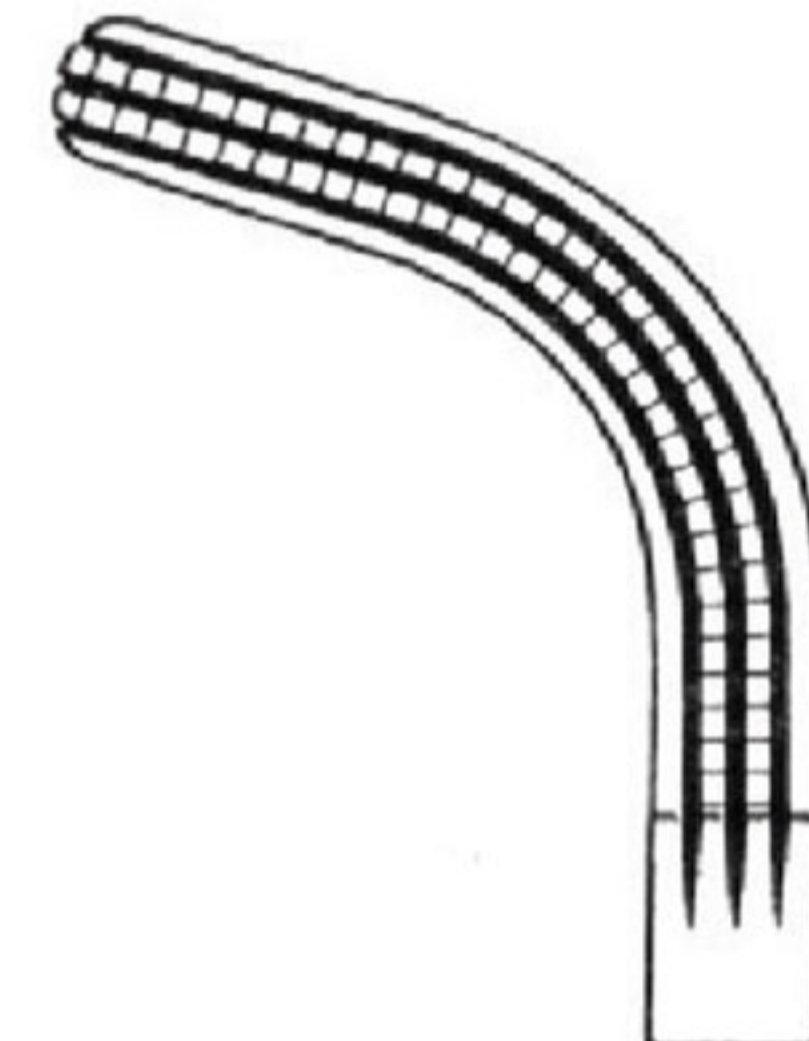

Fig. 4
OI 11-2705-20
20 cm/7 7/8"

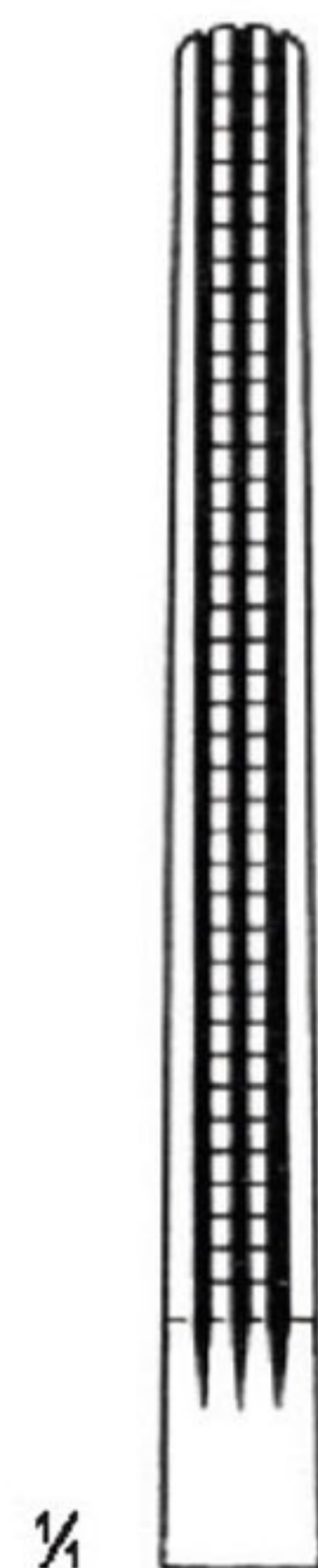

Fig. 1
OI 11-2706-25
25.5 cm/10"

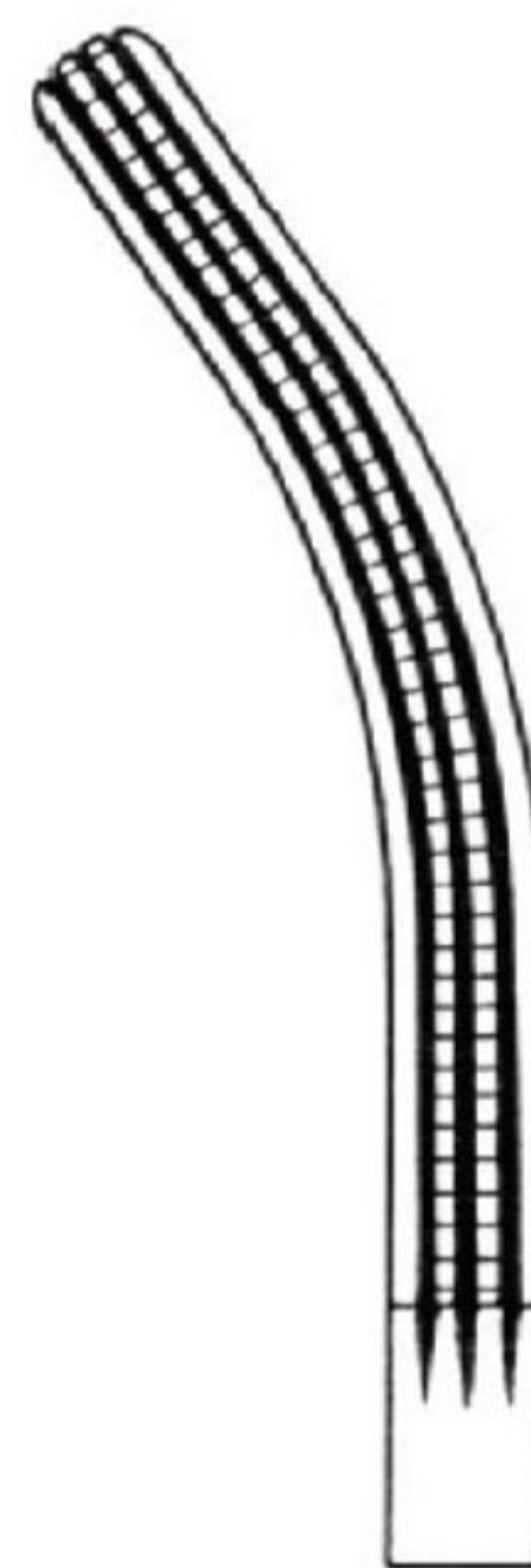
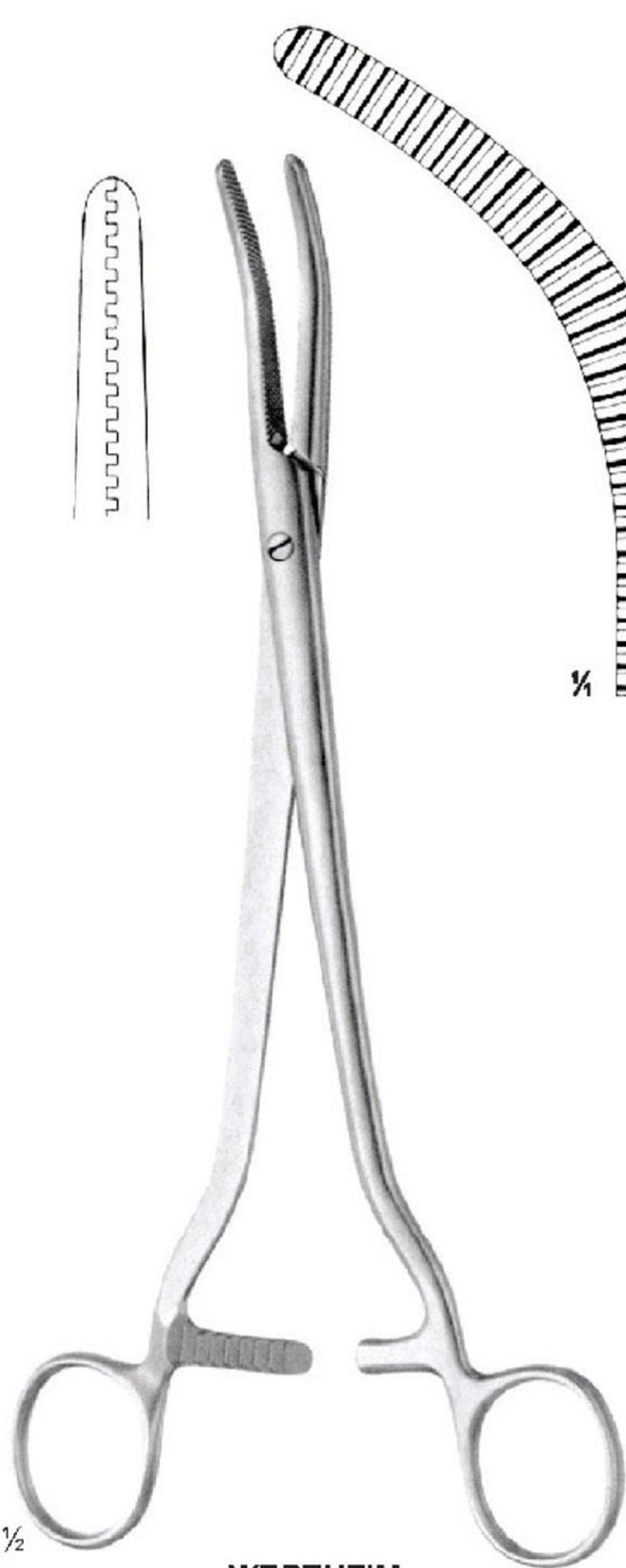

Fig. 2
OI 11-2707-25
25 cm/9 7/8"

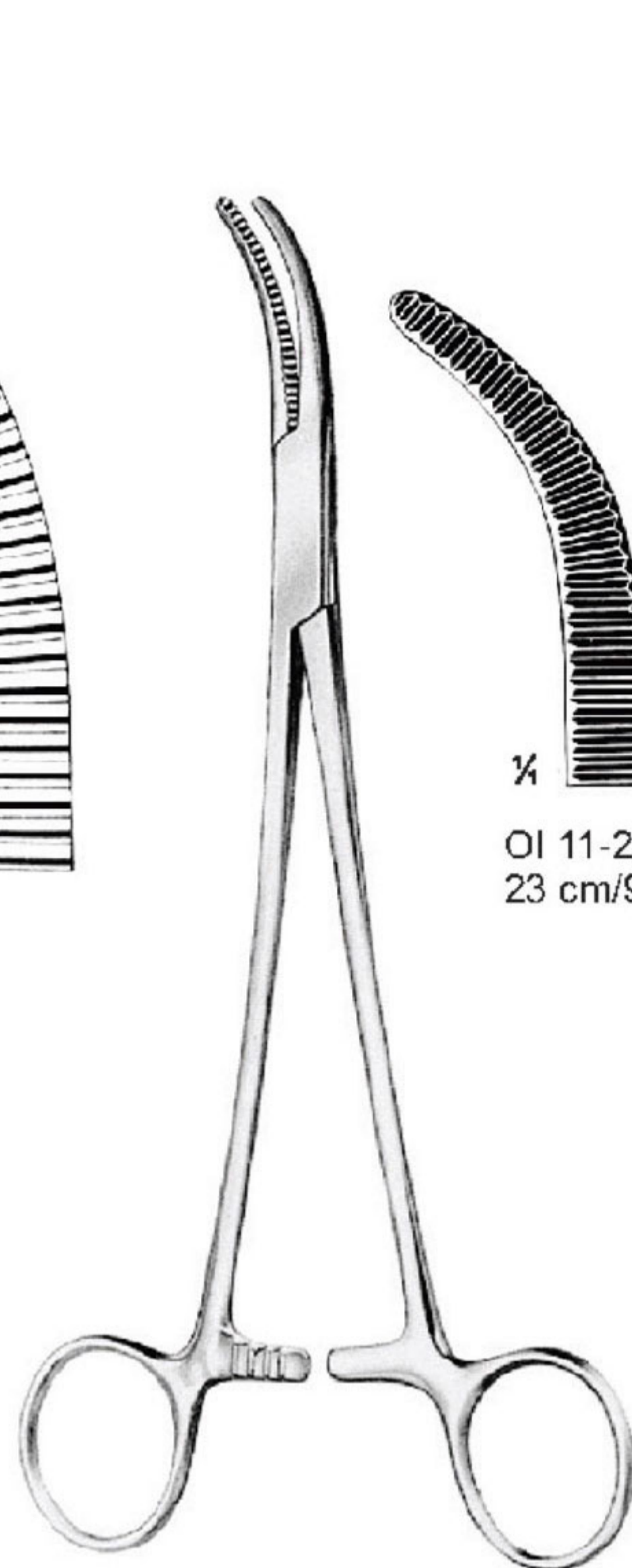

Fig. 3
OI 11-2708-24
24.5 cm/9 5/8"





WERTHEIM
OI 11-2709-25
25 cm/9 7/8"



MOYNIHAN



1/4
OI 11-2710-23
23 cm/9"



1/4
OI 11-2710-24
24 cm/9 1/2"

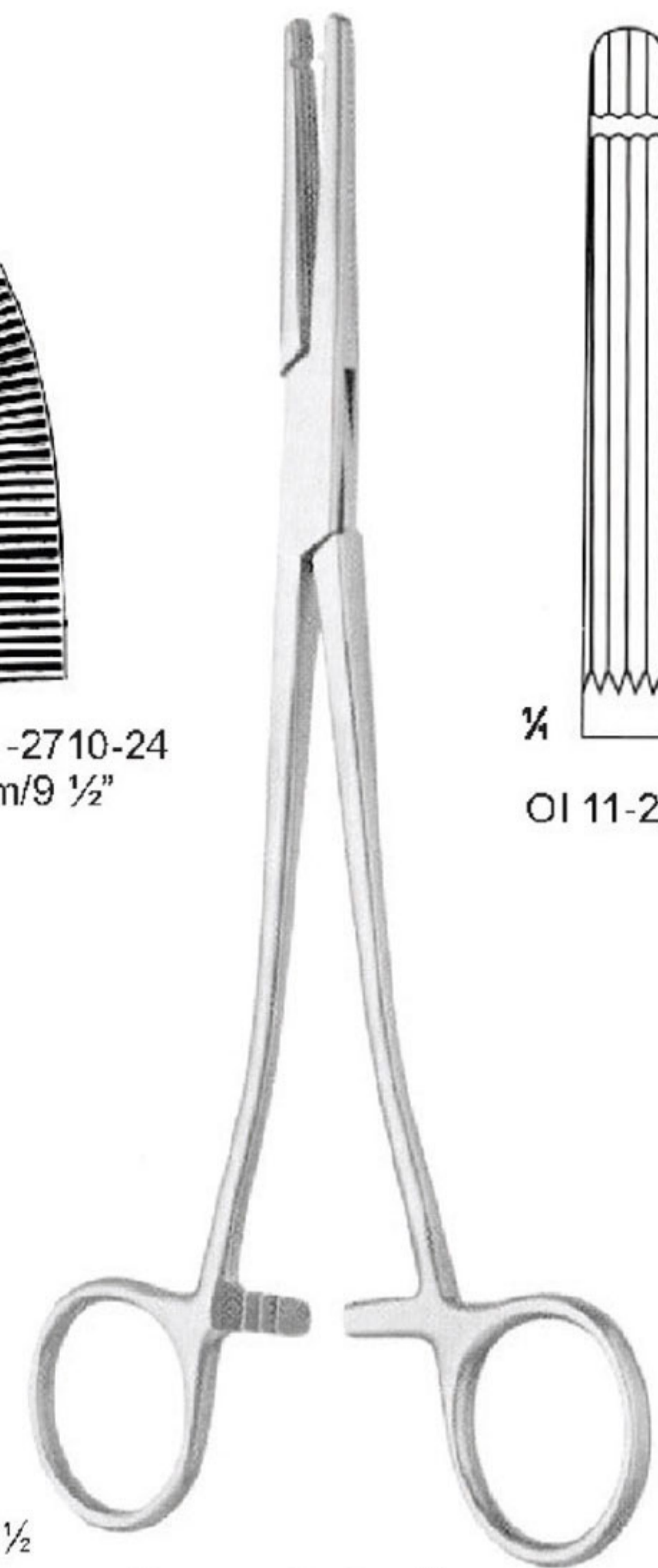

1/2
Heaney-Ballentine
21 cm/8 1/4"

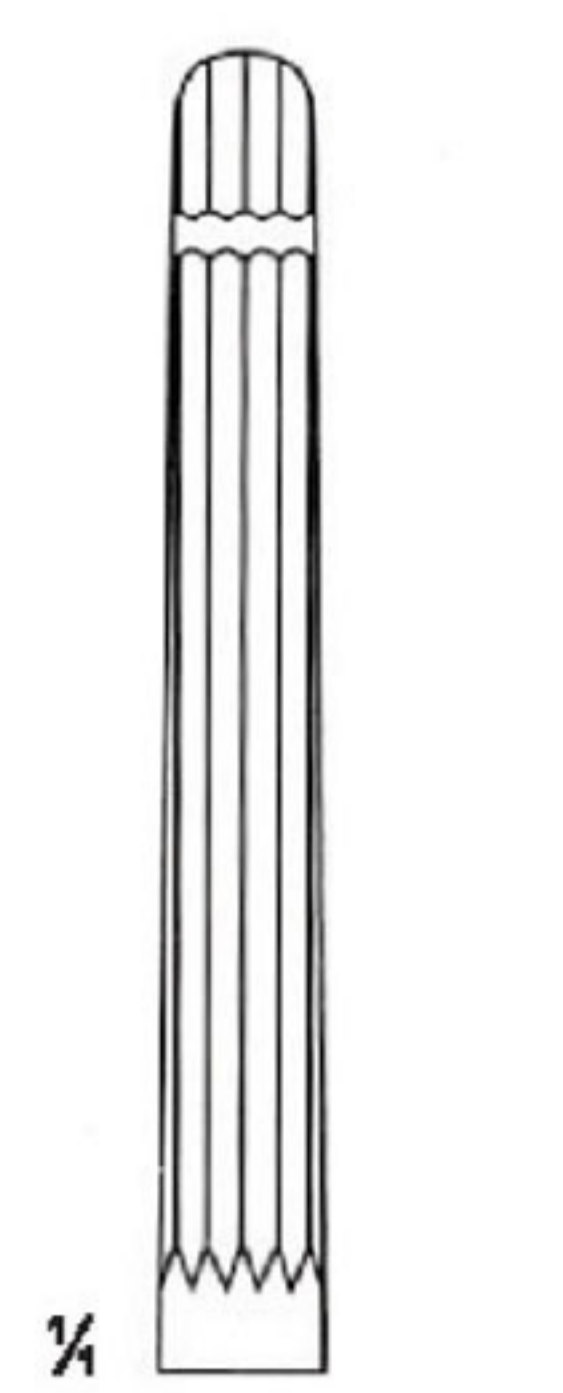

1/4
OI 11-2711-21



1/4
OI 11-2712-21

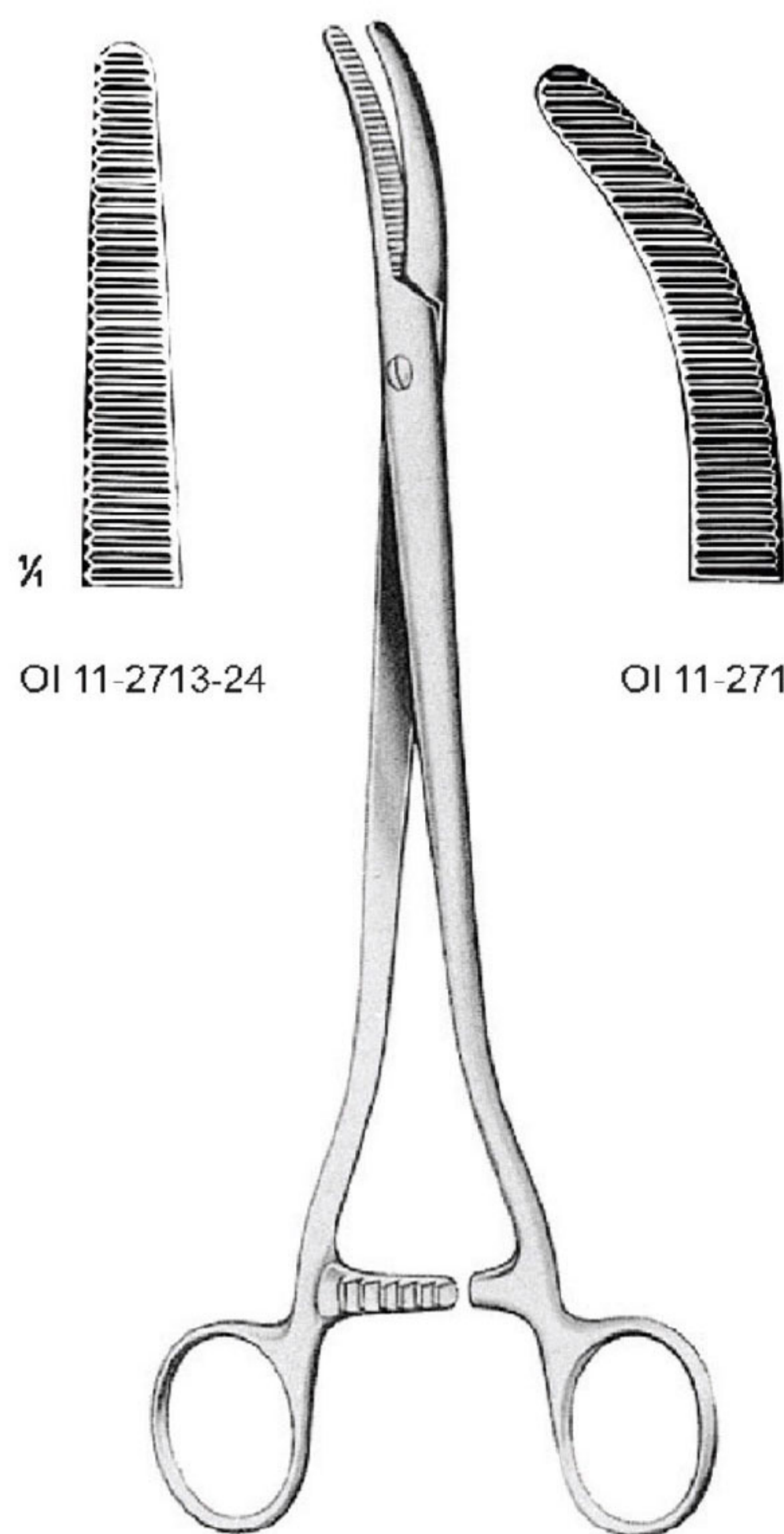

SEGOND-LANDAU
24 cm/9 1/2"

1/4
OI 11-2713-24



OI 11-2714-24

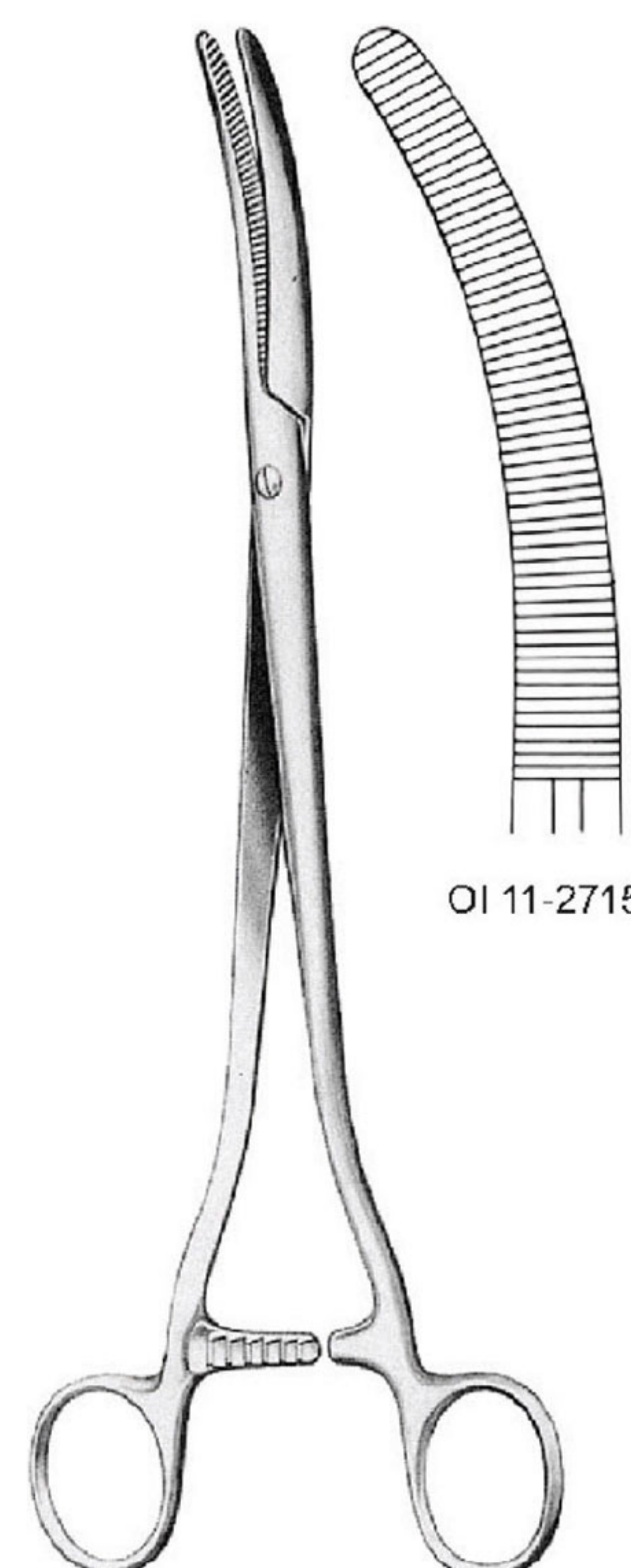

FAURE
25 cm/9 7/8"

OI 11-2715-25

ARTERY FORCEPS

Heavy pattern



WERTHEIM
23 cm/9"

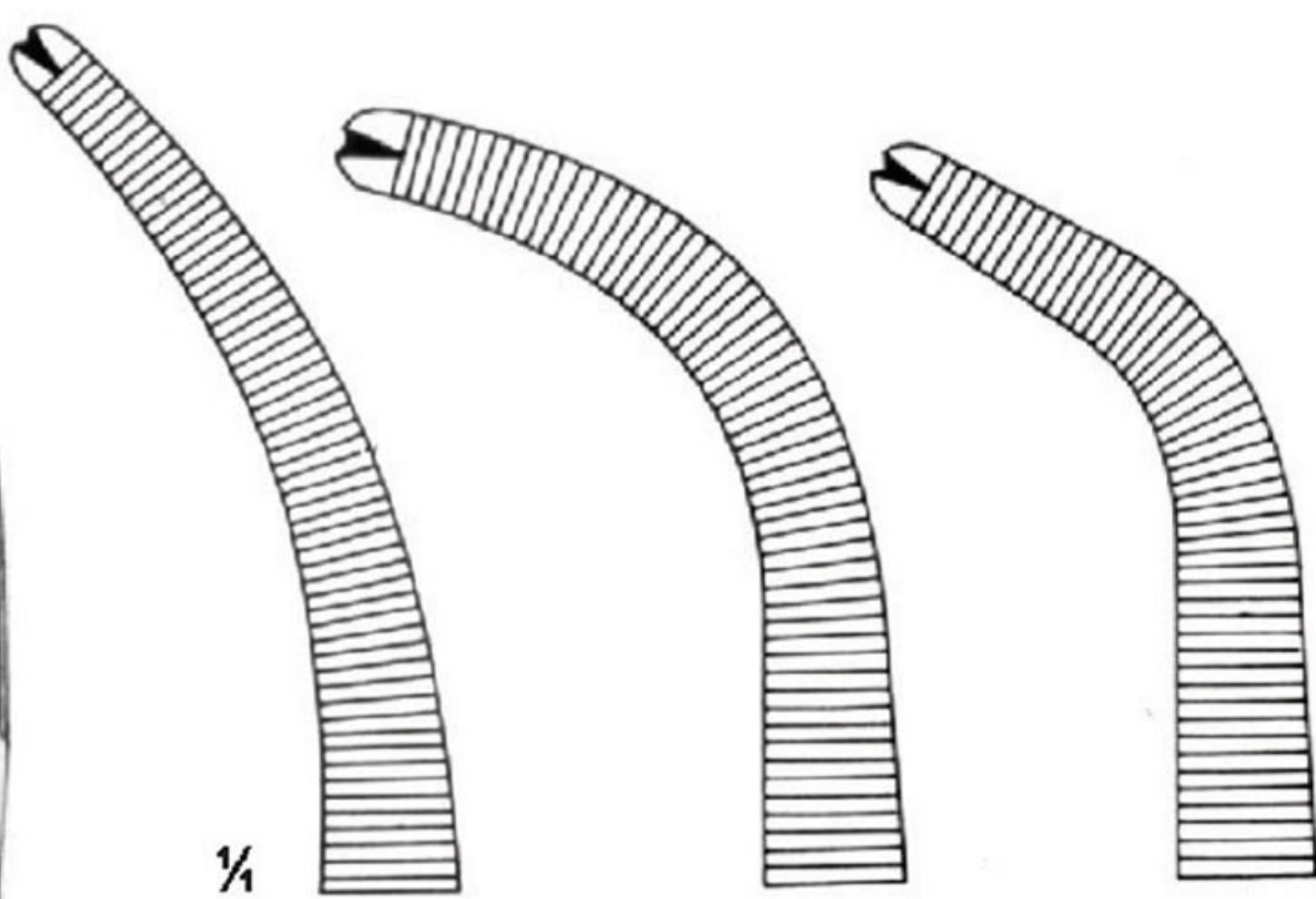

$\frac{1}{4}$
OI 11-2716-23 OI 11-2717-23 OI 11-2718-23

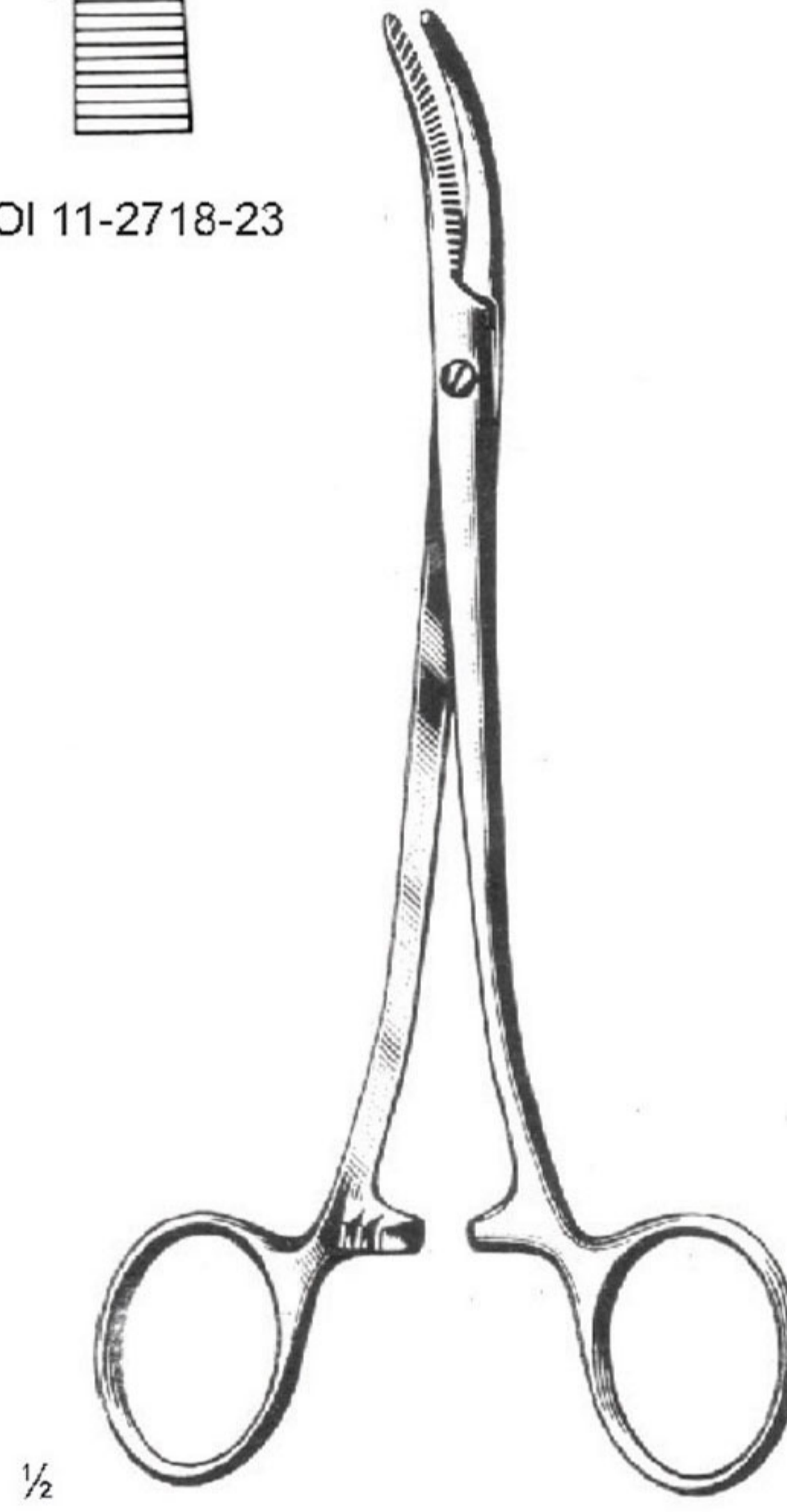

WERTHEIM
OI 11-2719-18
18 cm/7 $\frac{1}{8}$ "

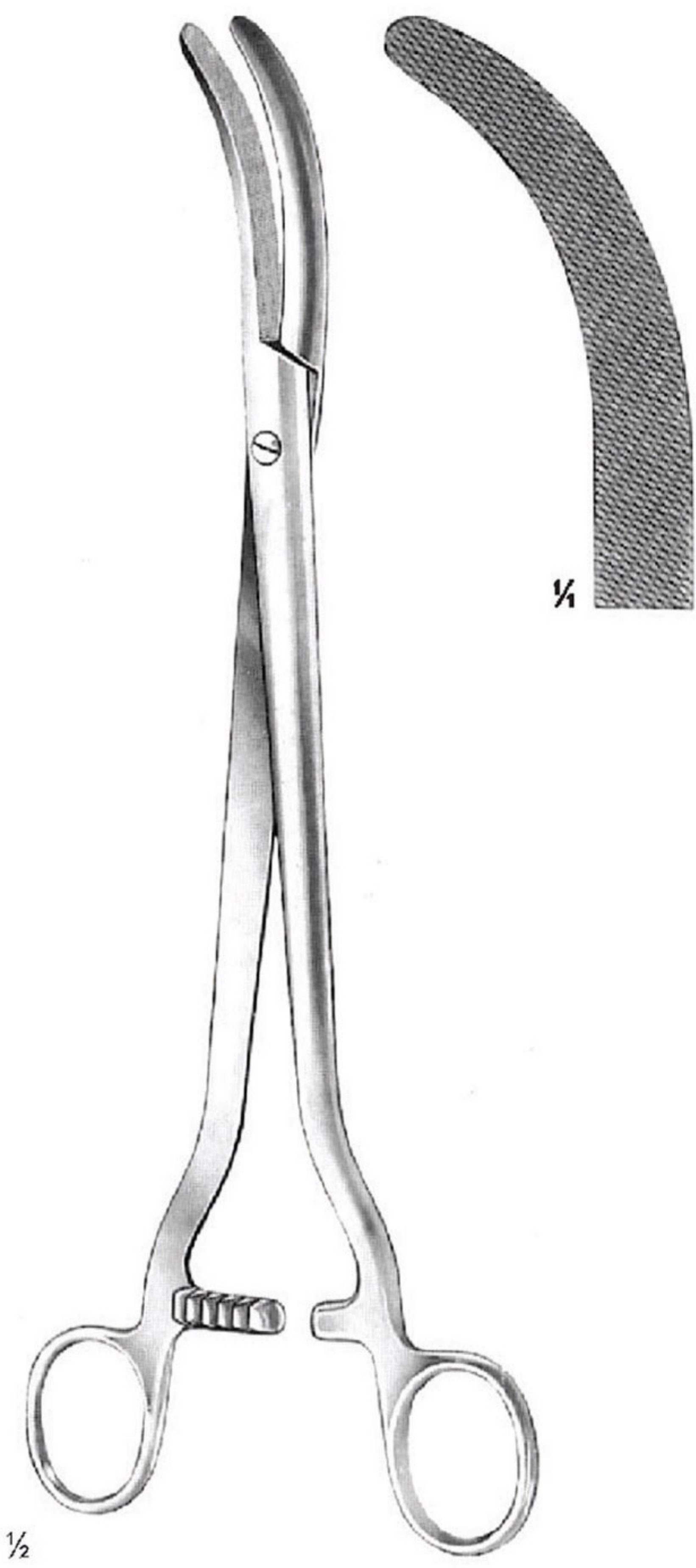

WERTHEIM
OI 11-2720-25
25 cm/9 $\frac{7}{8}$ "



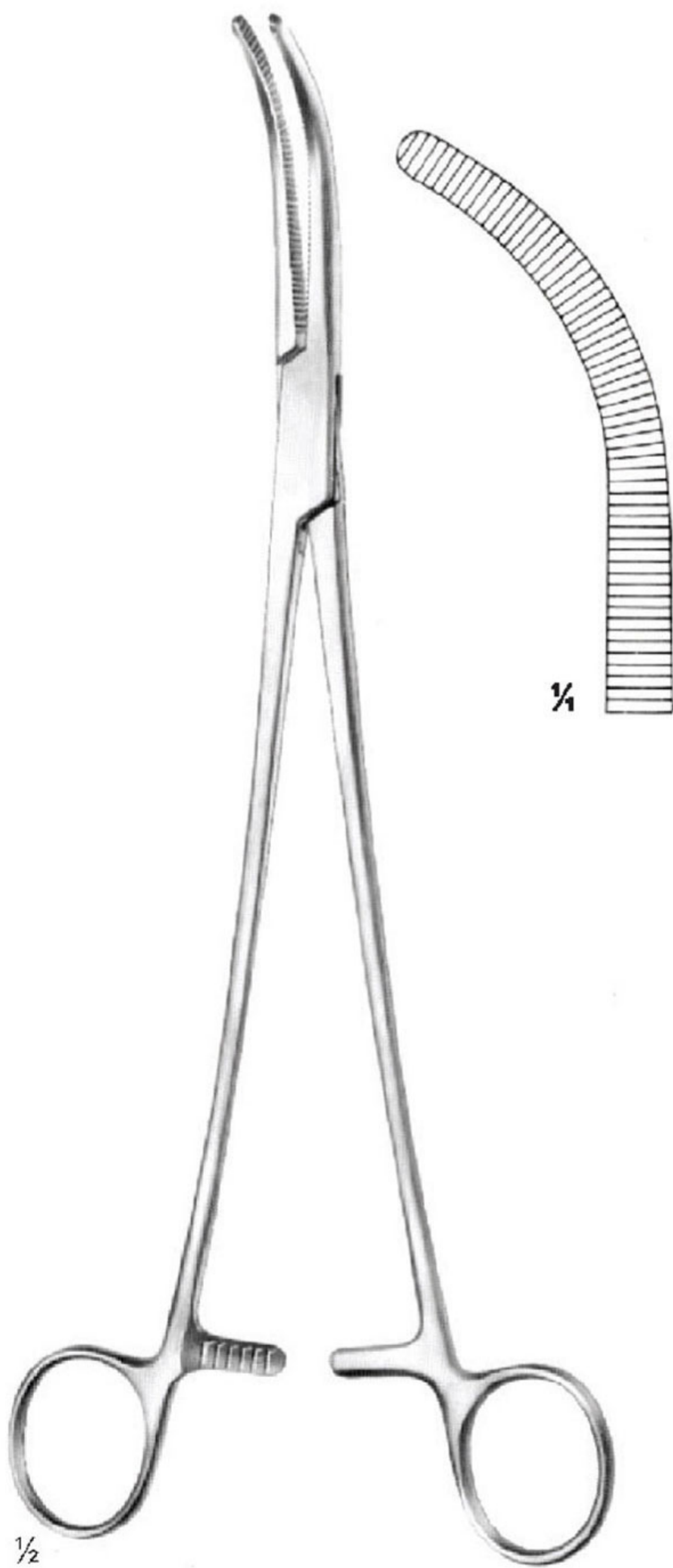

WERTHEIM
OI 11-2721-25
25 cm/9 7/8"

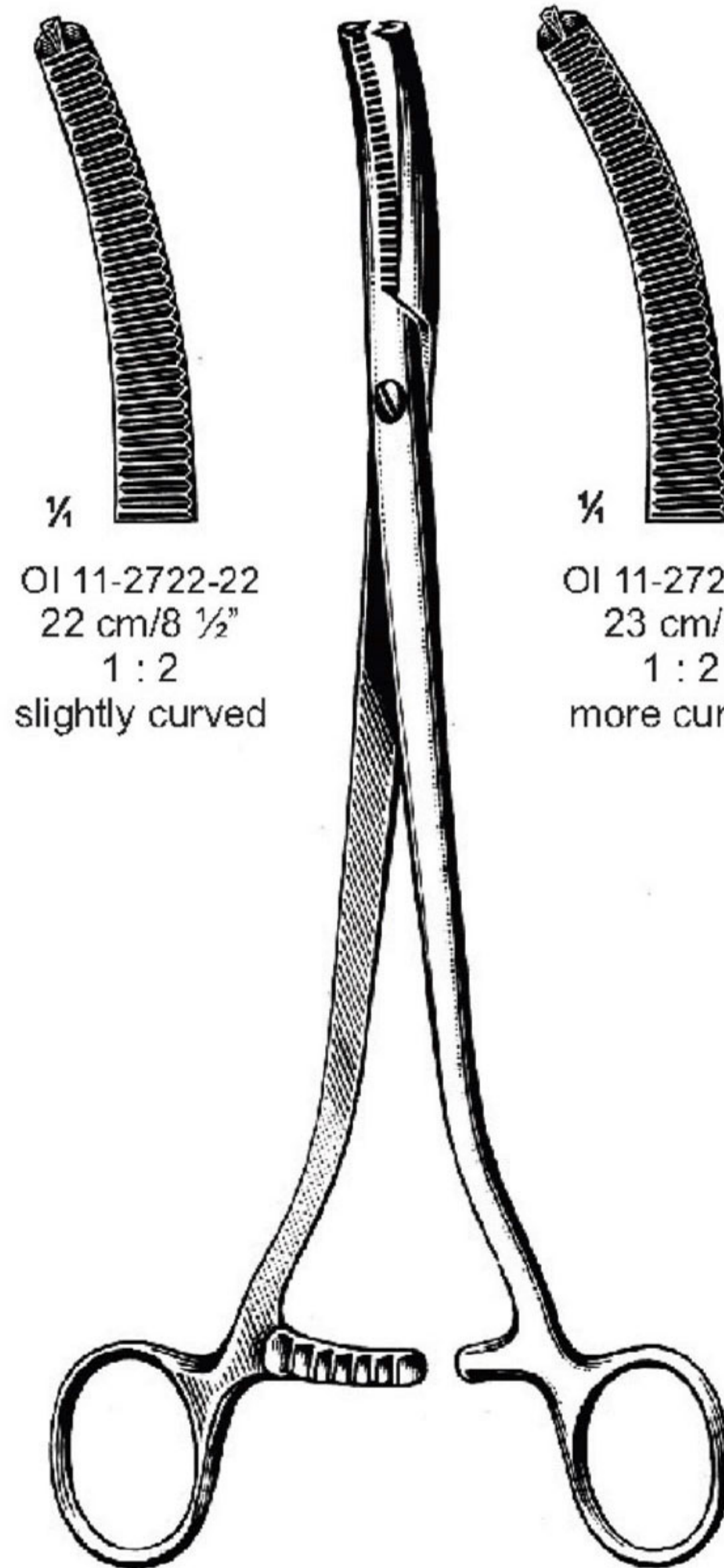
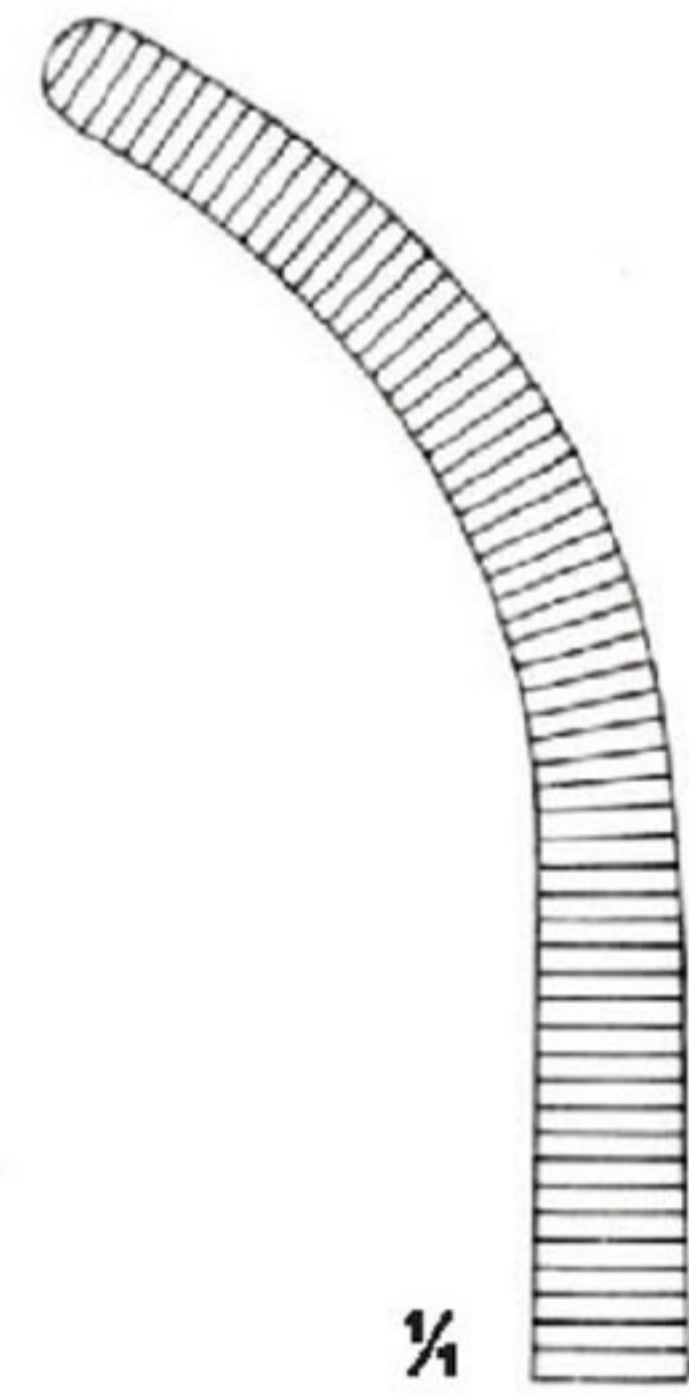

OI 11-2722-22
22 cm/8 1/2"
1 : 2
slightly curved

WERTHEIM



OI 11-2722-23
23 cm/9"
1 : 2
more curved

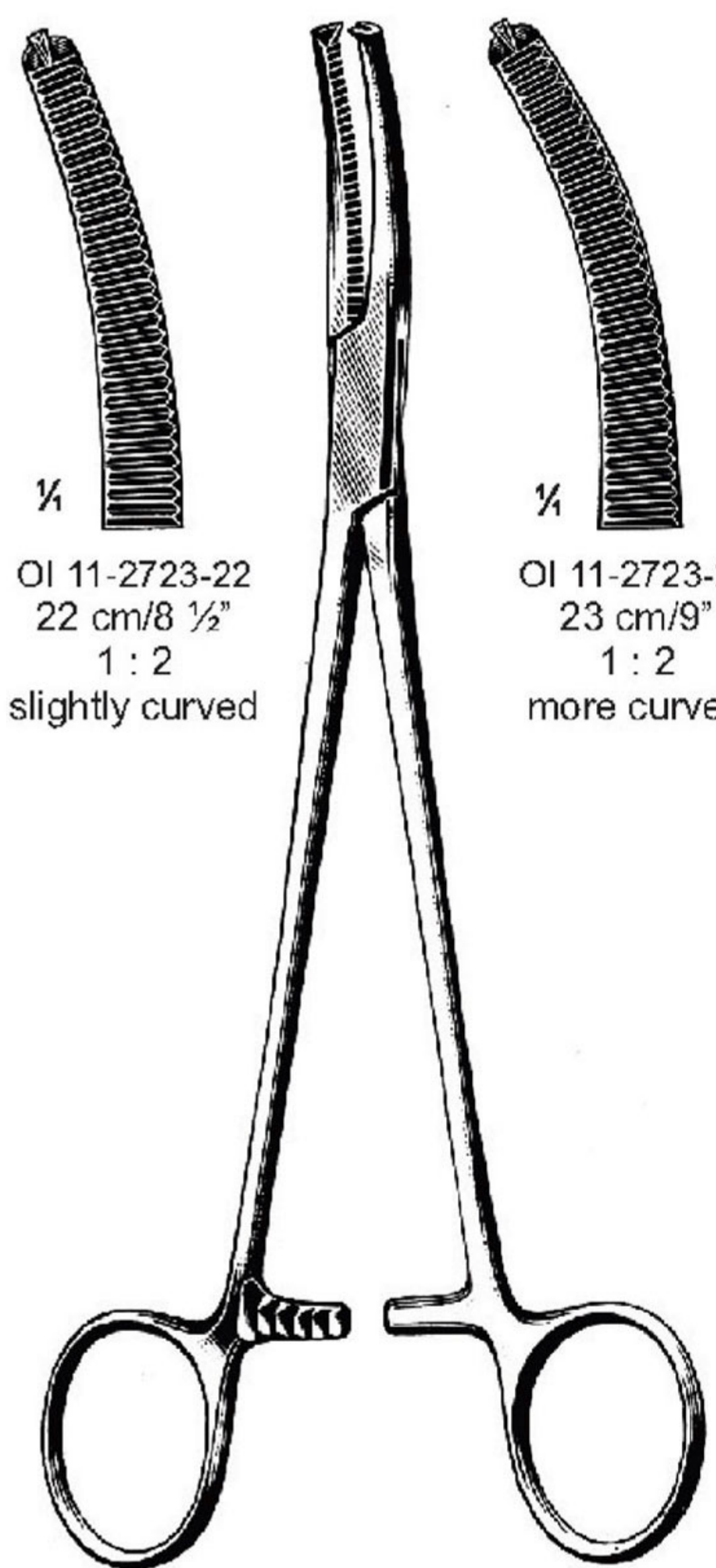

OI 11-2723-22
22 cm/8 1/2"
1 : 2
slightly curved

WERTHEIM

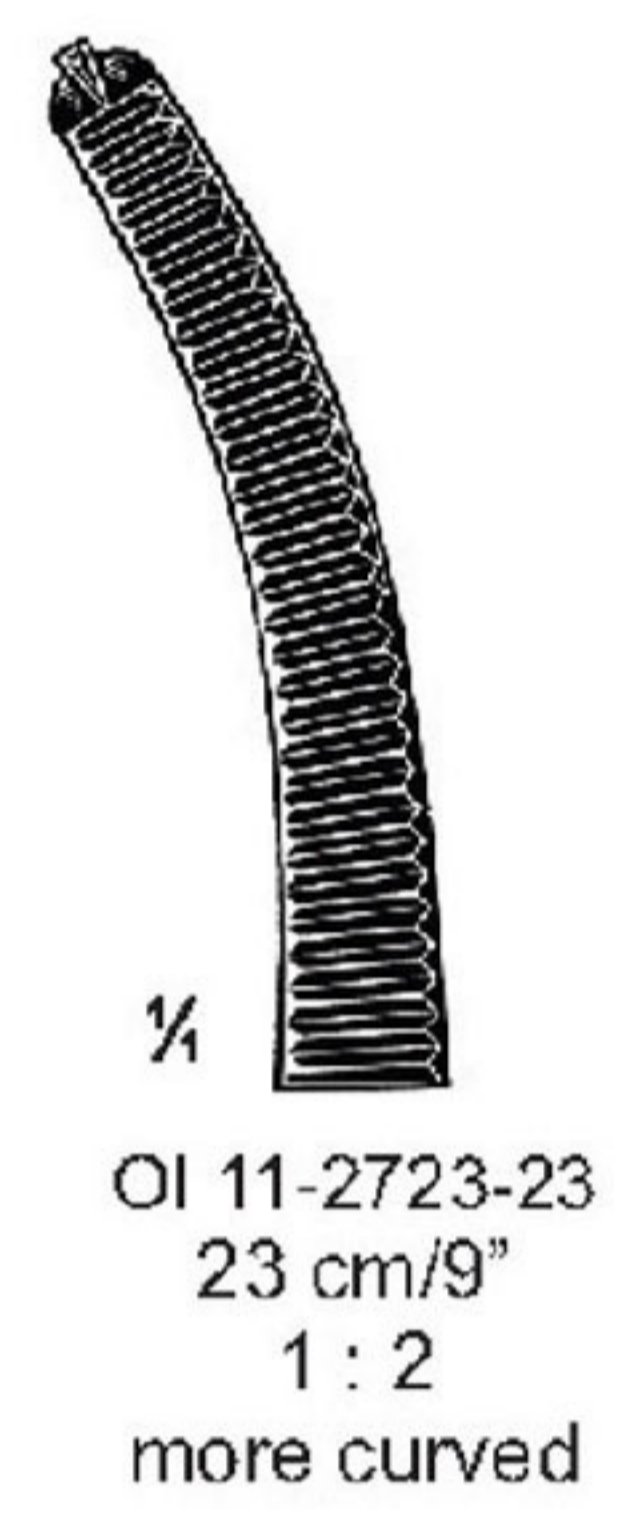

OI 11-2723-23
23 cm/9"
1 : 2
more curved

ARTERY FORCEPS

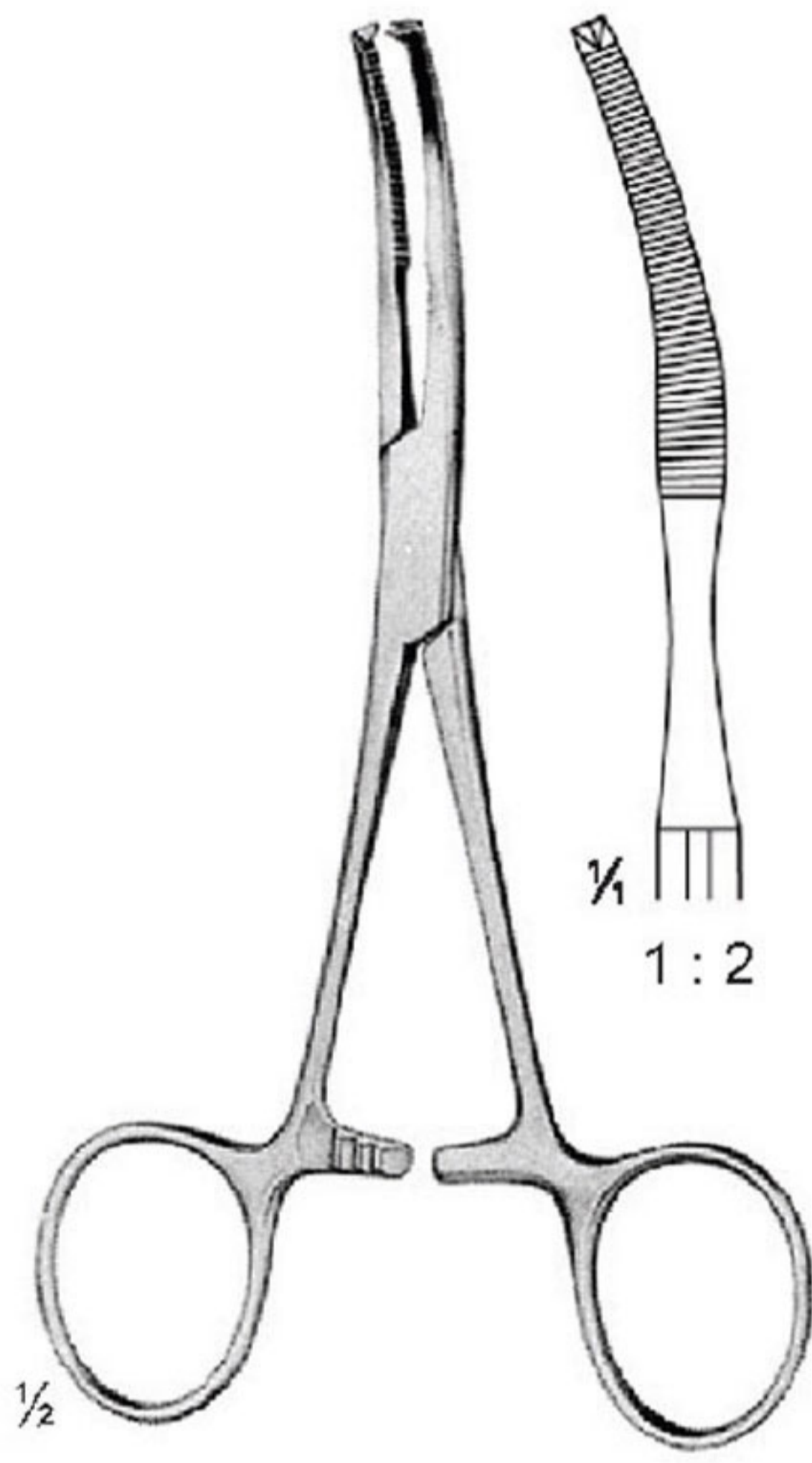

BABY-MIKULICZ
OI 11-2724-14
14 cm/5 1/2"

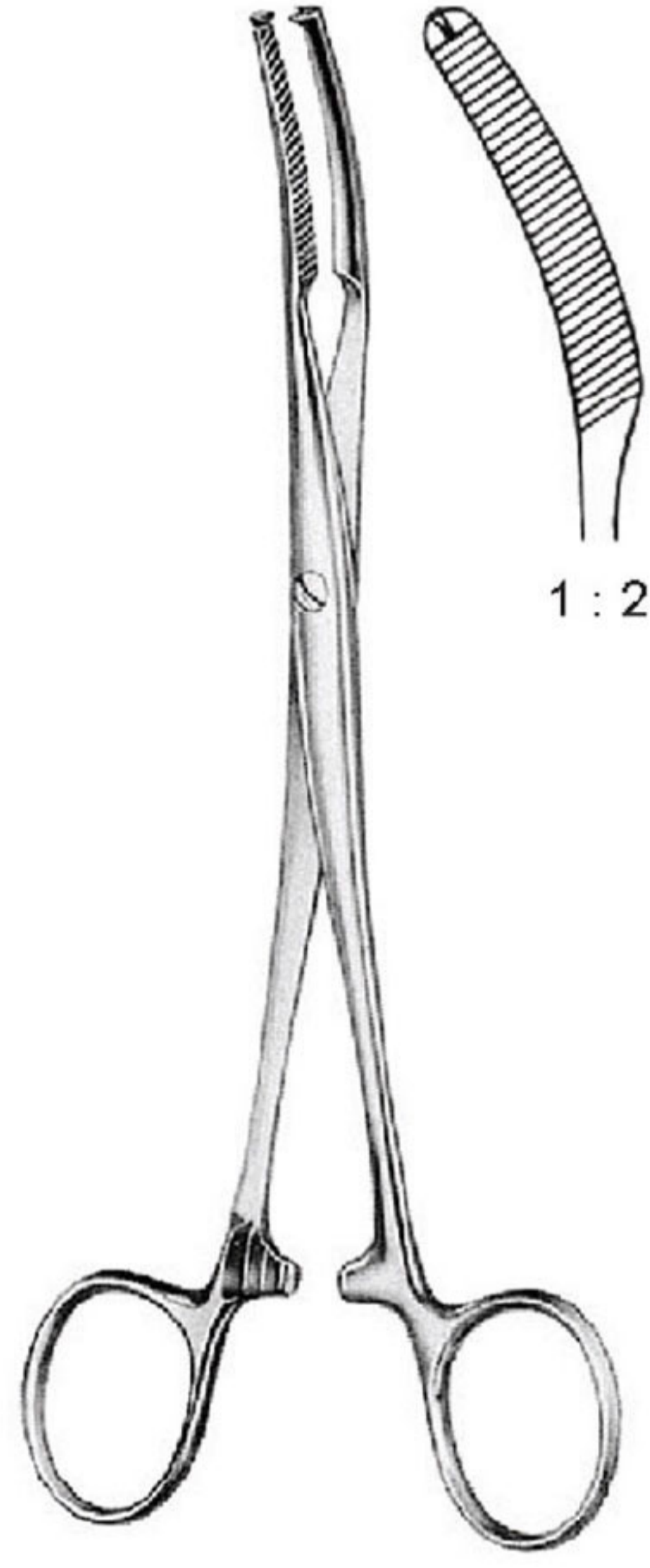

MIKULICZ
OI 11-2725-18 18 cm/7 1/8"
OI 11-2725-20 20 cm/7 7/8"

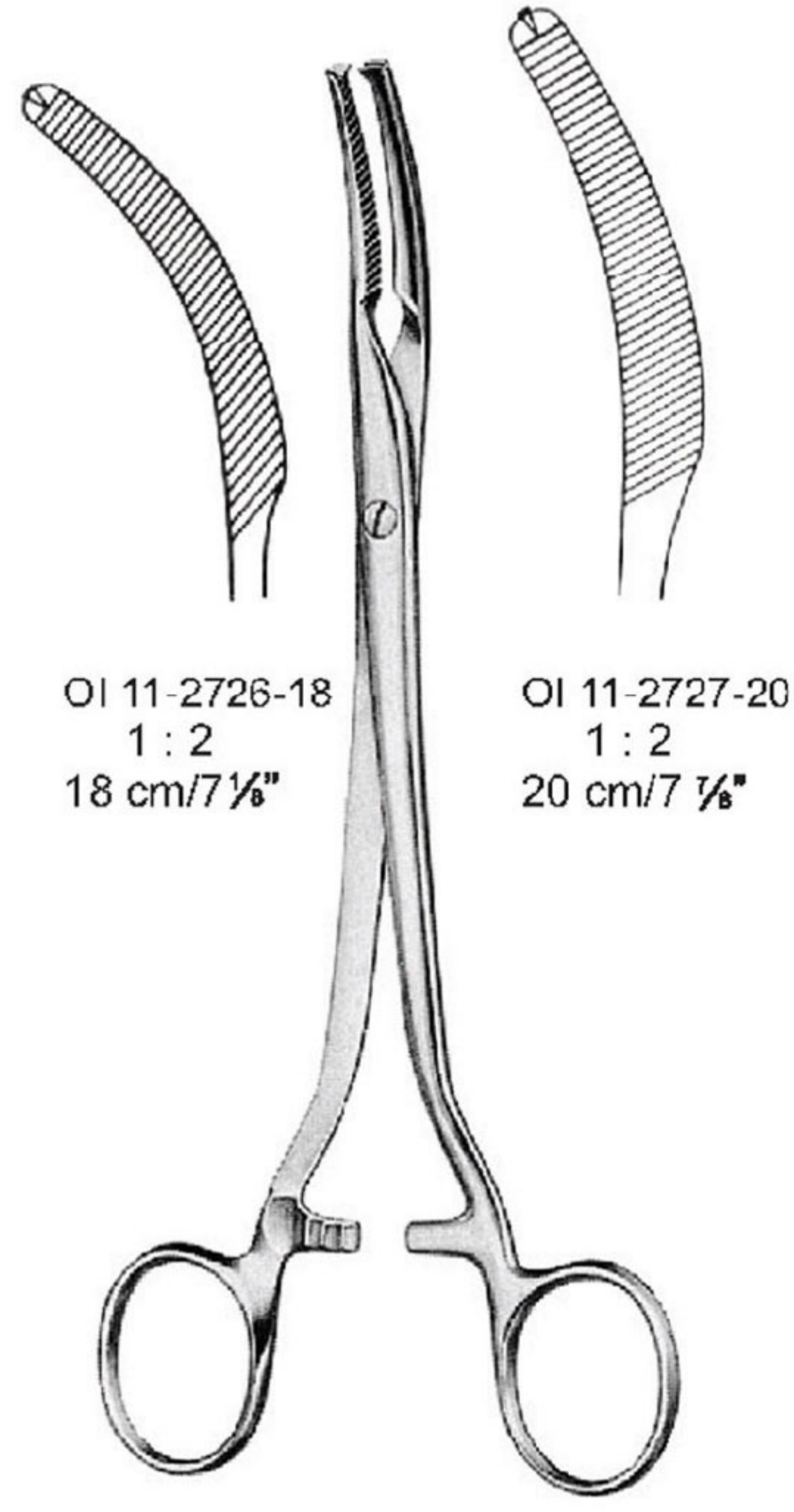

OI 11-2726-18
1: 2
18 cm/7 1/8"

OI 11-2727-20
1: 2
20 cm/7 7/8"

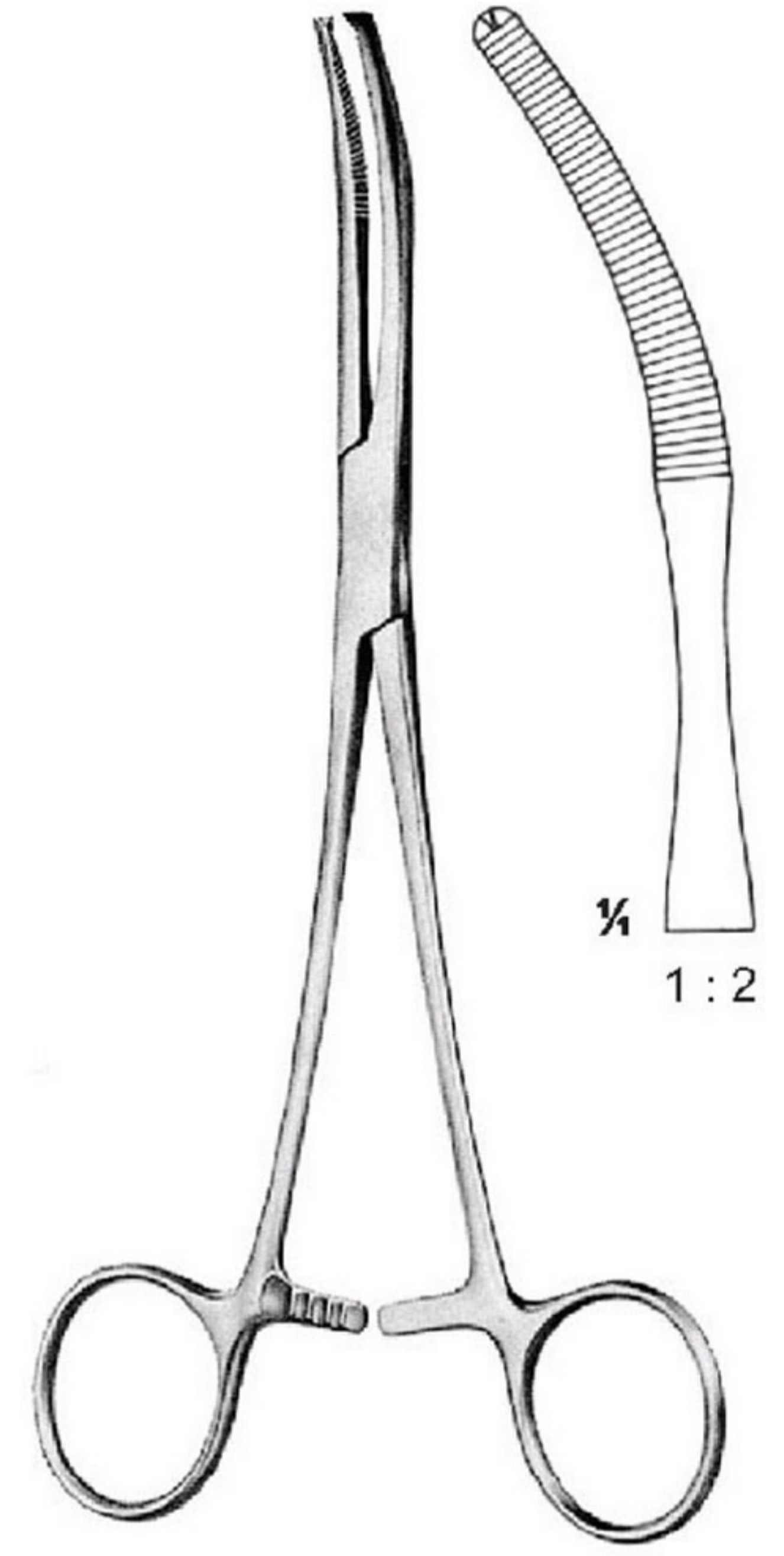

MIKULICZ
OI 11-2728-20 20 cm/7 7/8"

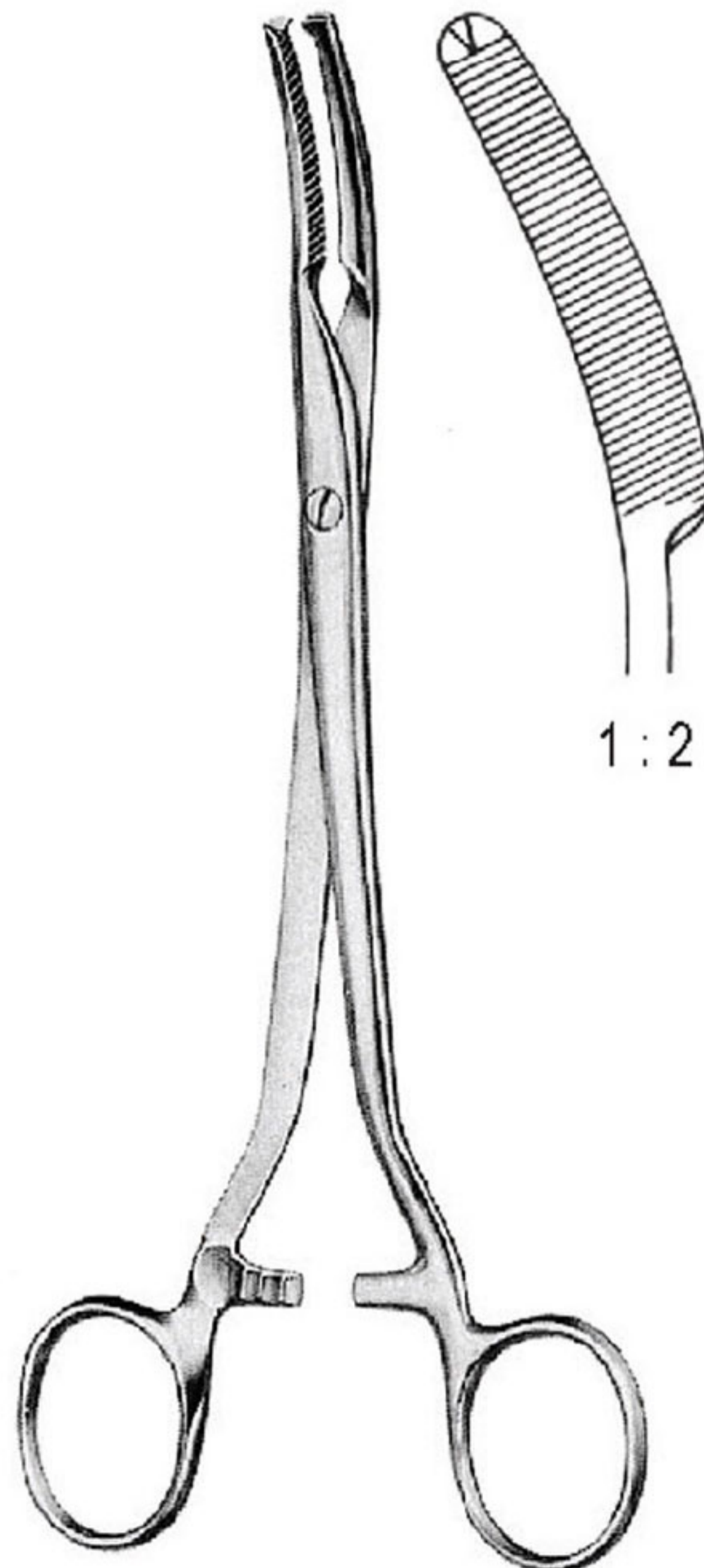

MIKULICZ
OI 11-2729-20
20.5 cm/8 1/8"

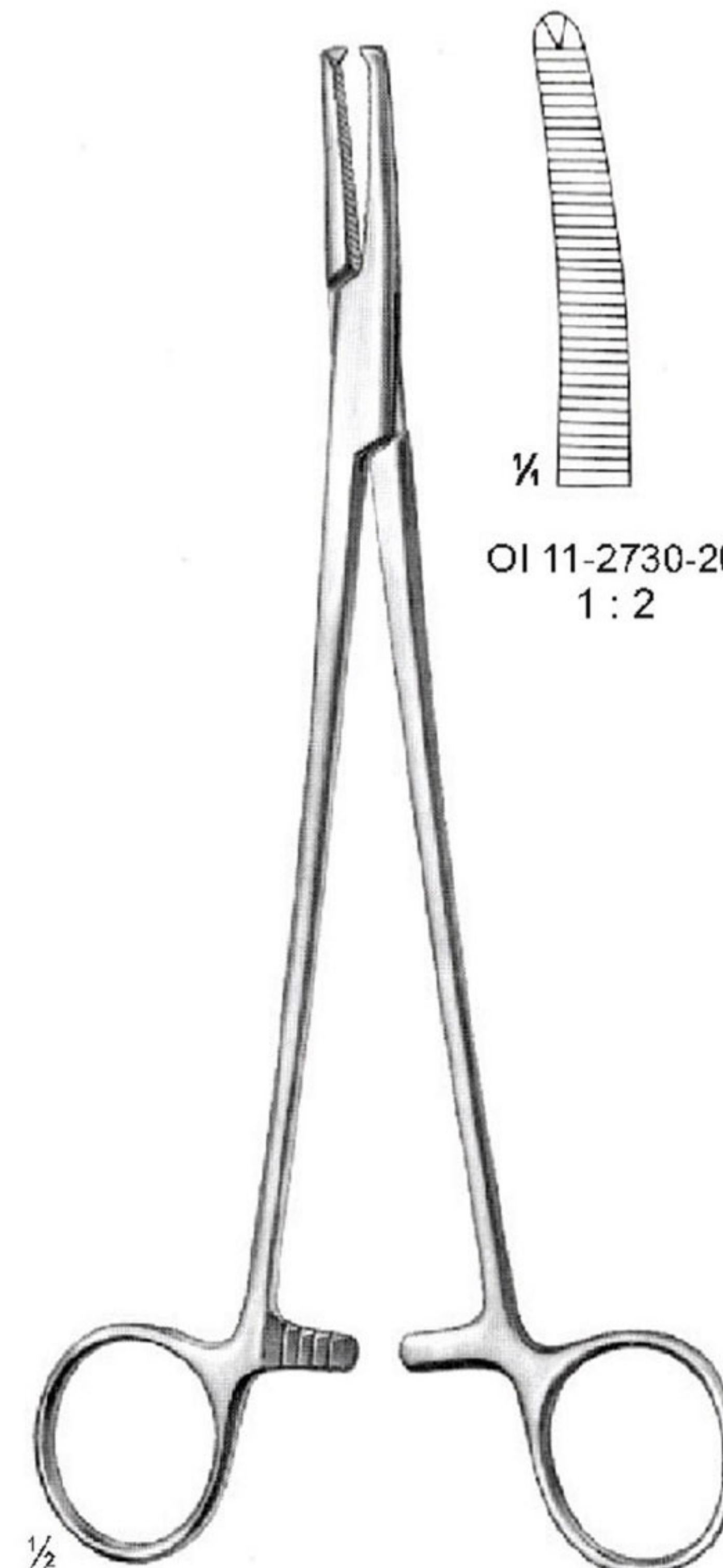

FAURE
20 cm/7 7/8"

OI 11-2730-20
1: 2

OI 11-2731-20
1: 2



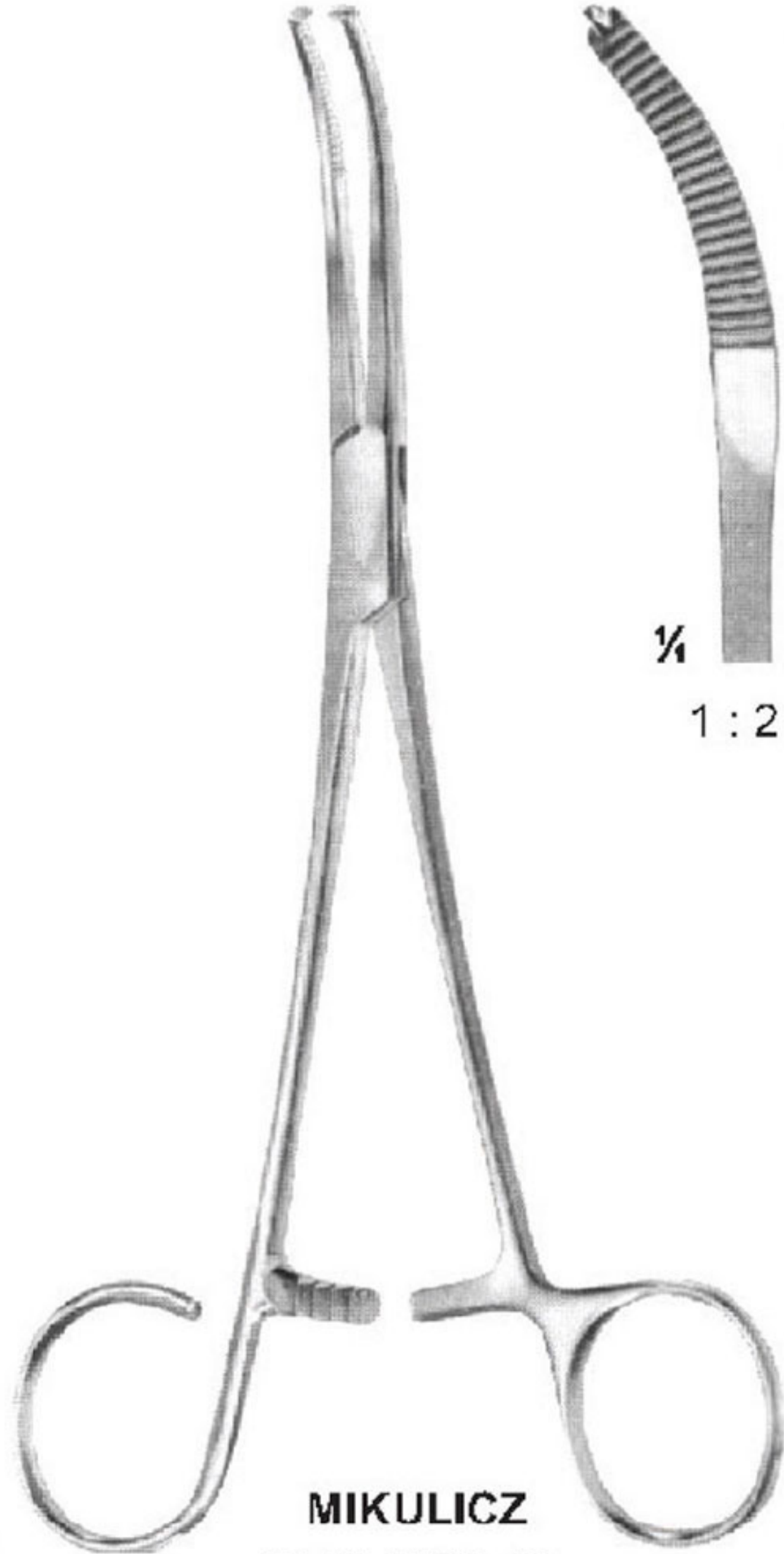
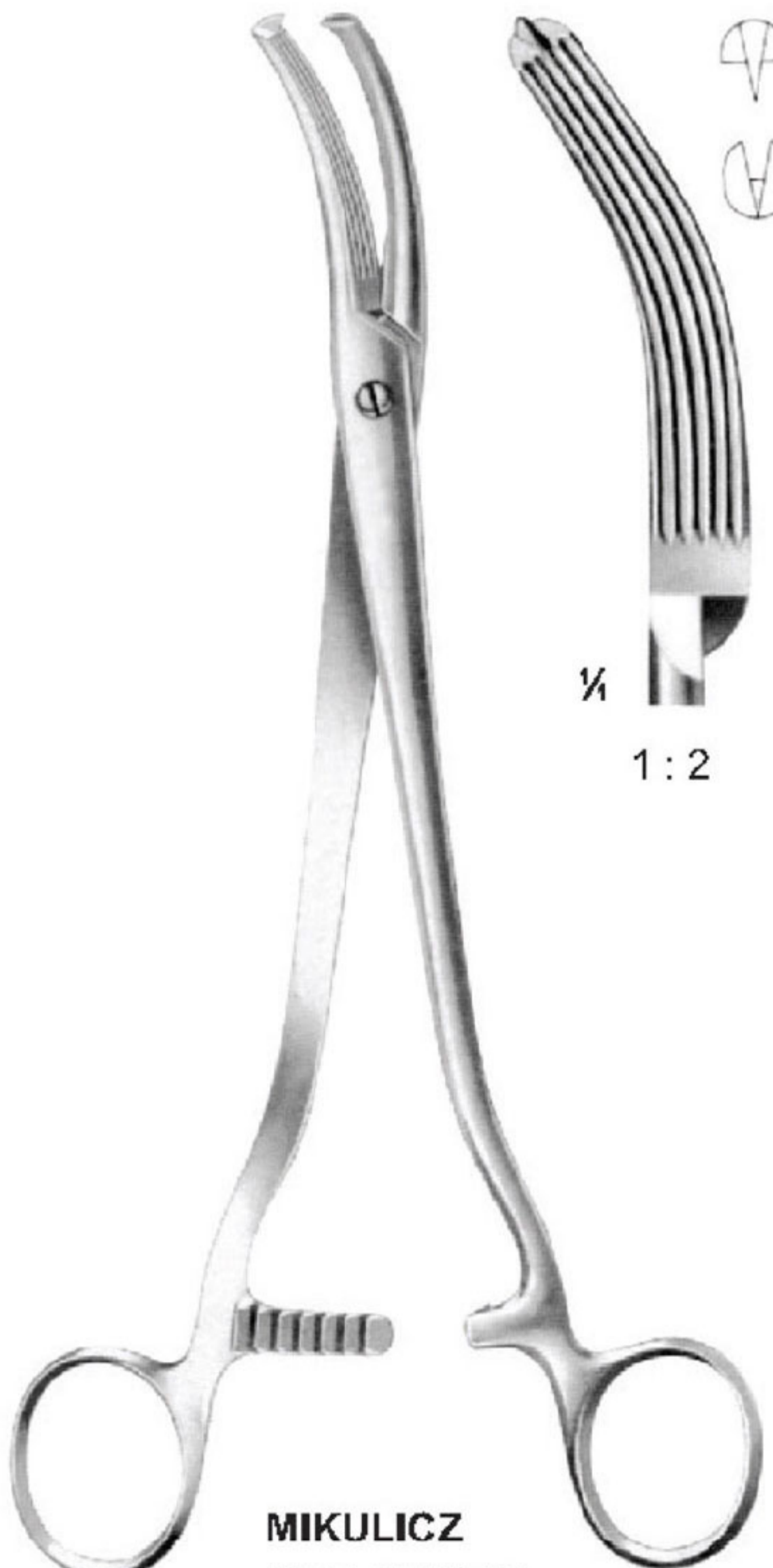
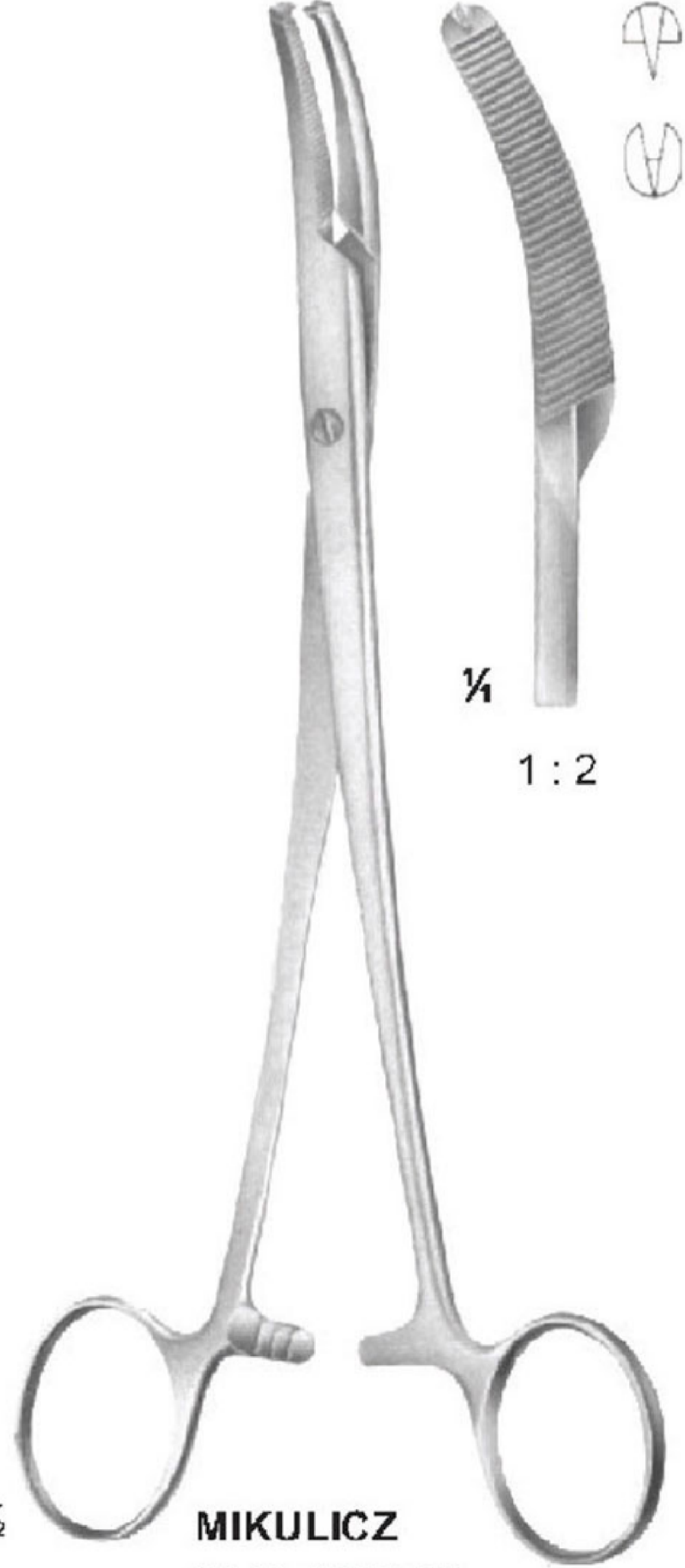

<p>½</p> <p>MIKULICZ OI 11-2732-18 18 cm/7 ¼"</p>	<p>½</p> <p>MIKULICZ OI 11-2733-20 20 cm/7 ⅞"</p>	<p>½</p> <p>MIKULICZ OI 11-2734-20 20.5 cm/8 ⅛"</p>
<p>½</p>  <p>¼ 1:2</p> <p>MIKULICZ OI 11-2735-18 18.5 cm/7 ¼"</p>	<p>½</p>  <p>¼ 1:2</p> <p>MIKULICZ OI 11-2736-24 24.5 cm/9 ⅝"</p>	<p>½</p>  <p>¼ 1:2</p> <p>MIKULICZ OI 11-2737-20 20 cm/7 ⅞"</p>

ARTERY FORCEPS

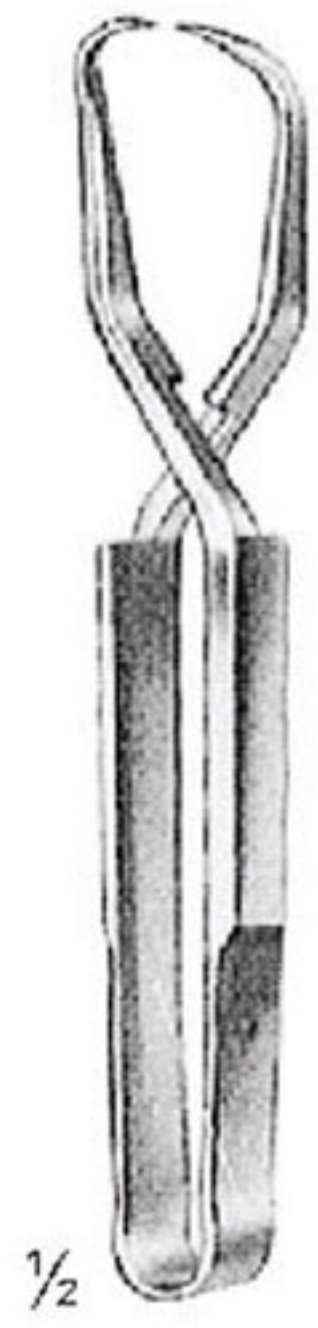

SCHAEDEL
OI 11-2738-09 9 cm/3 1/2"

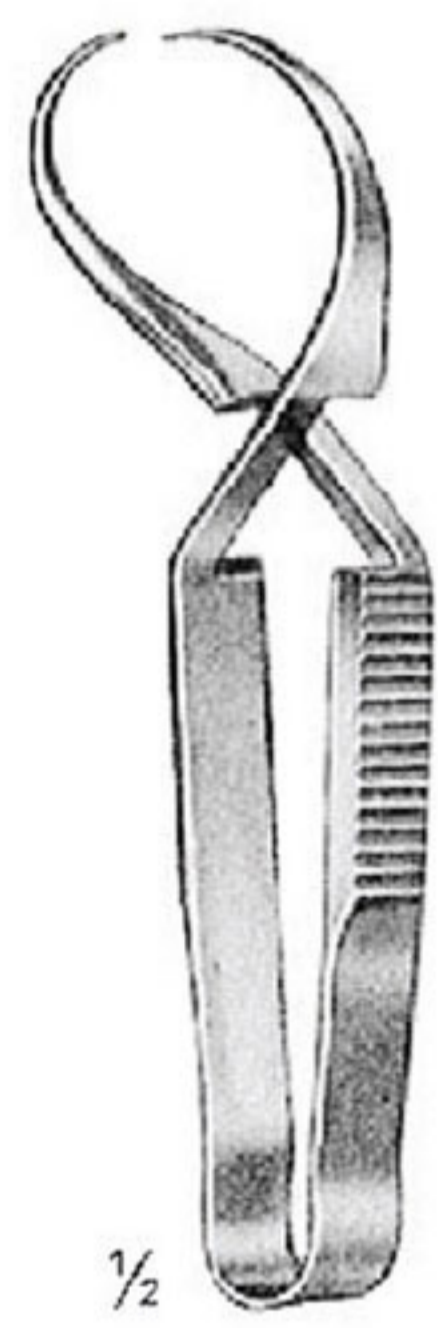

ENGL. MODELL
OI 11-2739-09 9 cm/3 1/2"

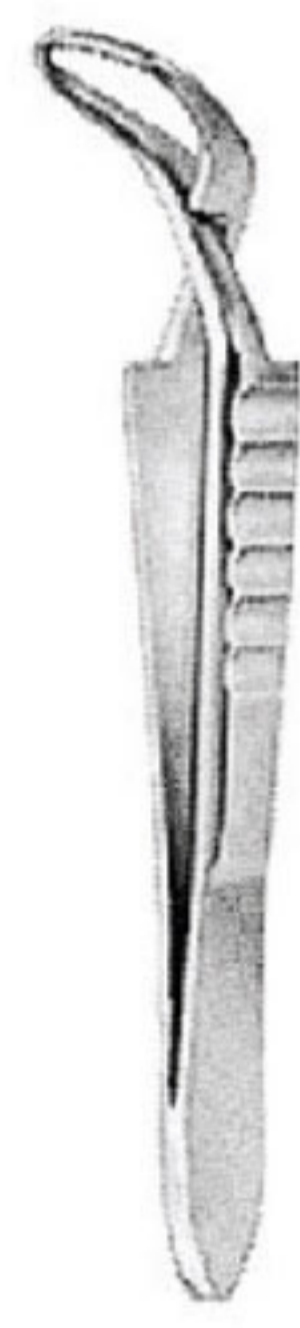

JONES
OI 11-2740-05 5 cm/2"
OI 11-2740-09 9 cm/3 1/2"



JONES
OI 11-2741-09 9 cm/3 1/2"



DOYEN
OI 11-2742-11 11 cm/4 3/8"



DOYEN
OI 11-2743-18 18 cm/7 1/8"



With Clip for Tubing or Cable



BACKHAUS
OI 11-2744-11 11 cm/4 3/8"
OI 11-2744-13 13 cm/5 1/8"
Delicate pattern, sharp



BACKHAUS
OI 11-2745-11 11 cm/4 3/8"
With Clip for Tubing or Cable

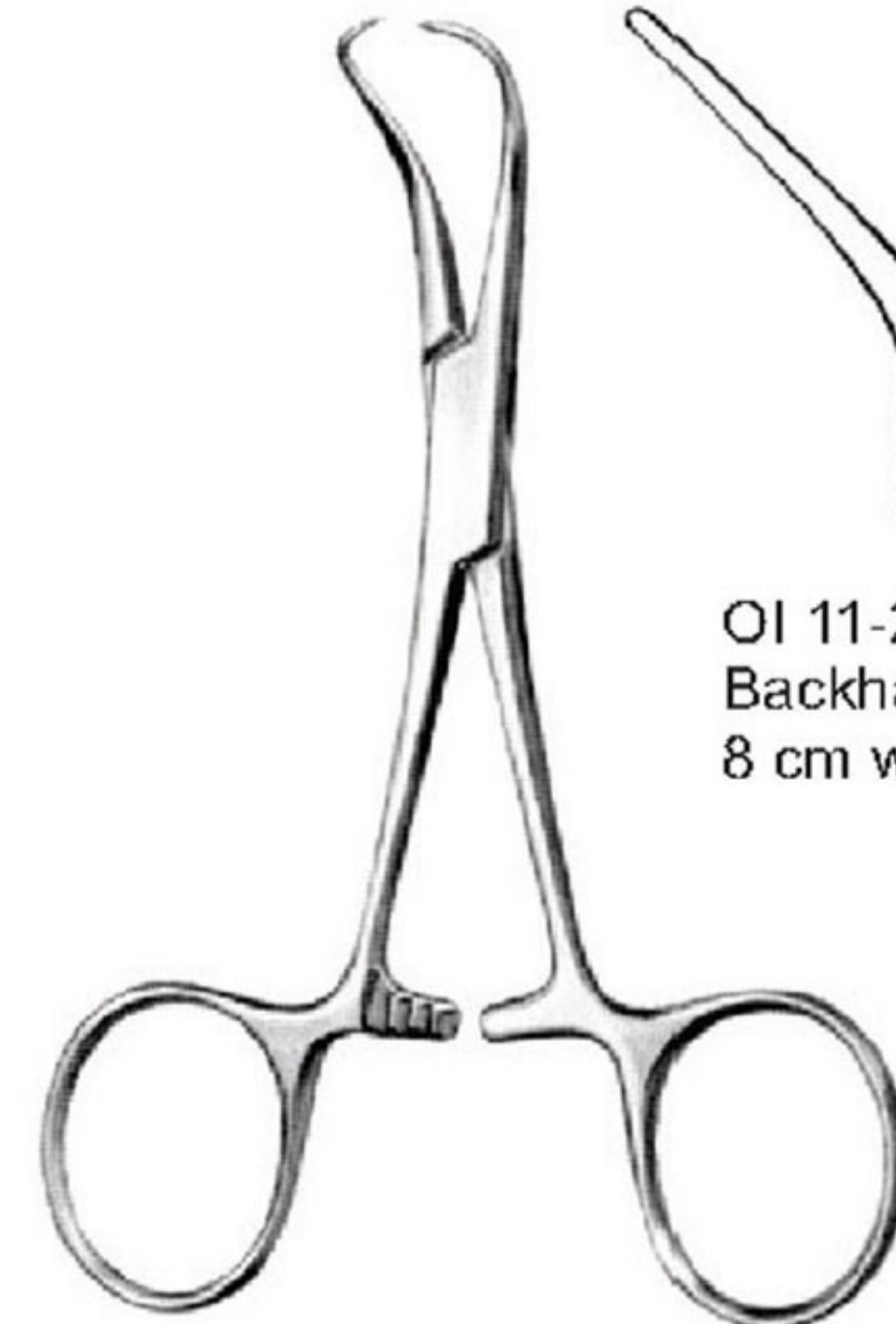

BACKHAUS
OI 11-2746-08 8 cm/3 1/4"
OI 11-2746-08 11 cm/4 3/8"
OI 11-2746-08 13 cm/5 1/8"
OI 11-2746-08 15 cm/5 7/8"

OI 11-2747-08
Backhaus Towel
8 cm with open jaws



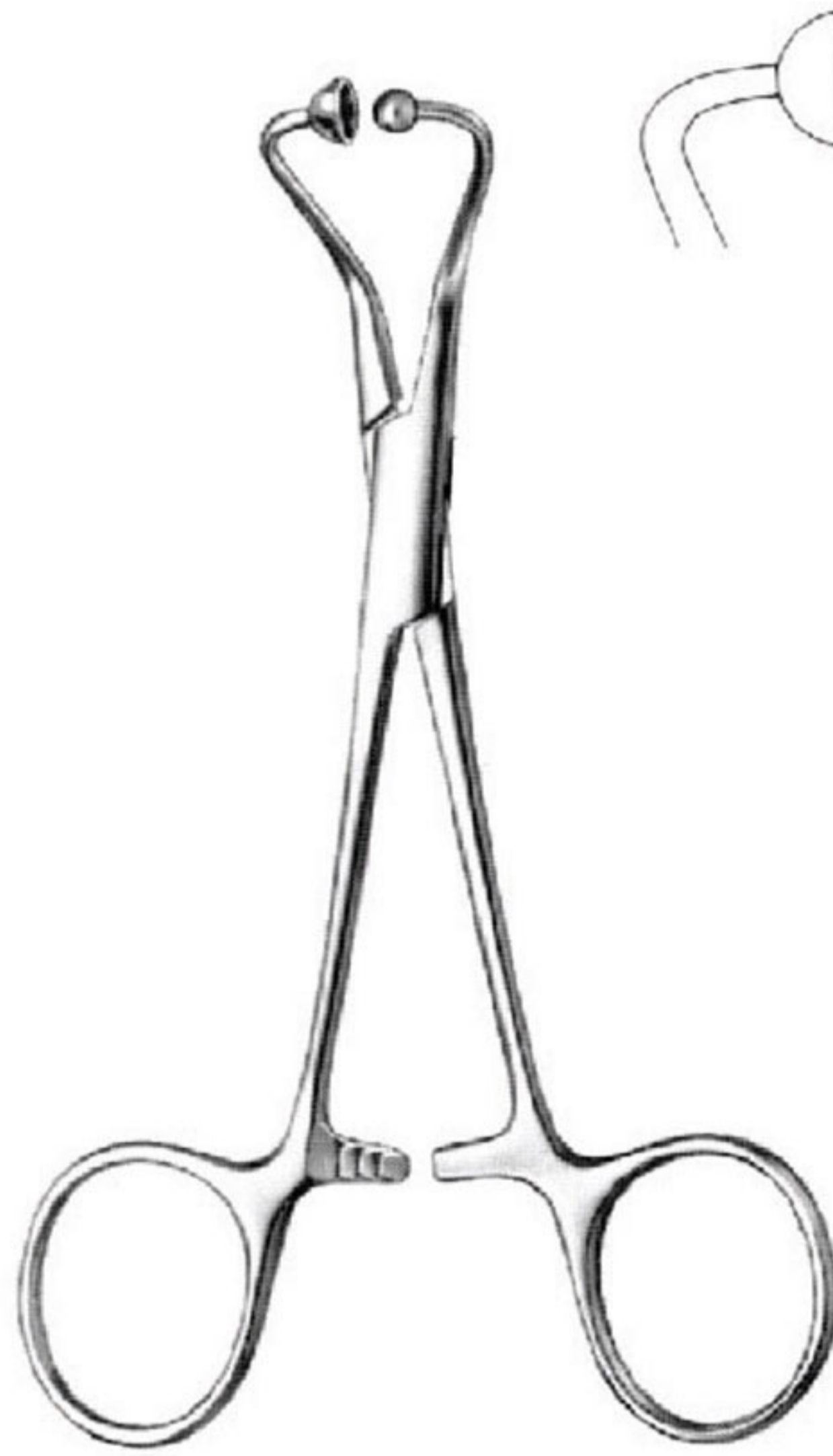

BALL & SOCKET
OI 11-2748-11 11.5 cm/4 1/2"
OI 11-2748-14 14 cm/5 1/2"

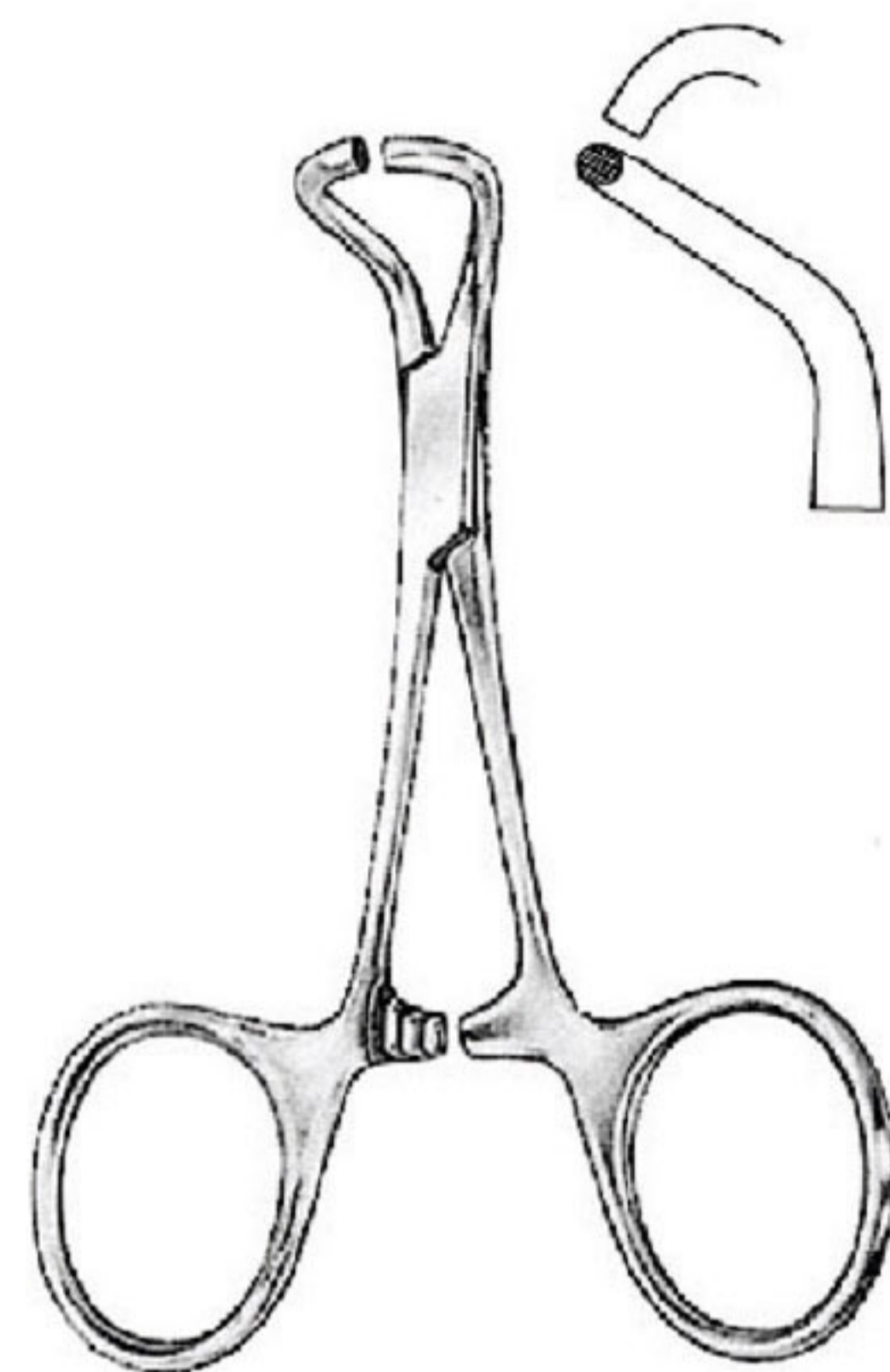
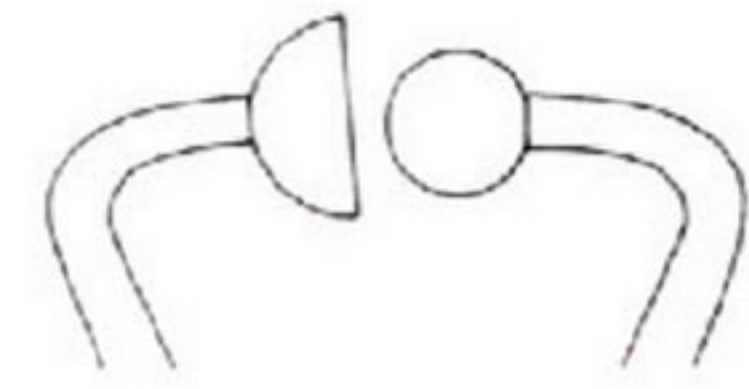

TOHOKU
OI 11-2749-10 10.5 cm/4 1/8"
OI 11-2749-13 13.5 cm/5 3/8"

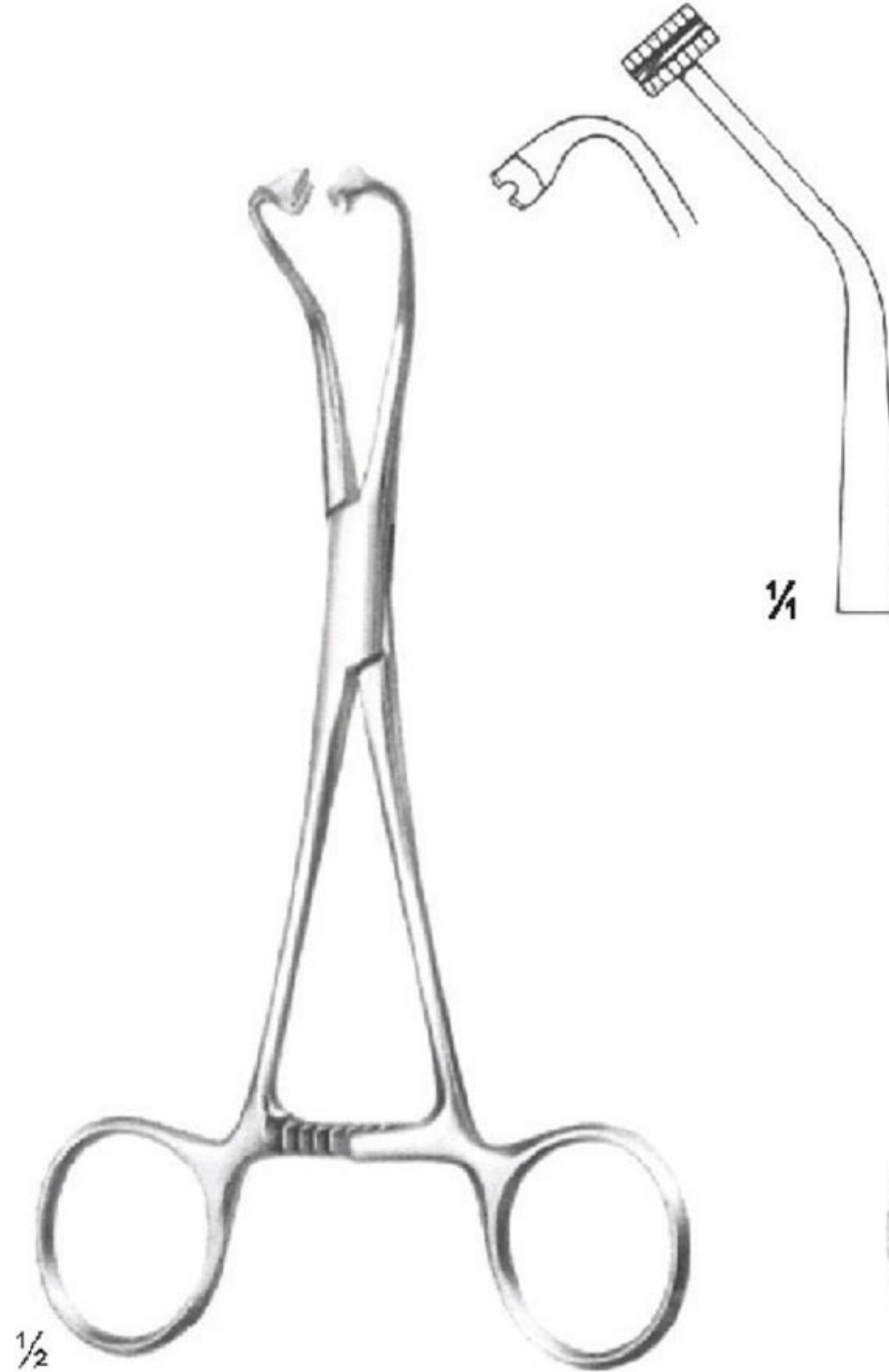

PEERS BERTRAM
OI 11-2750-14 14.5 cm/5 3/4"

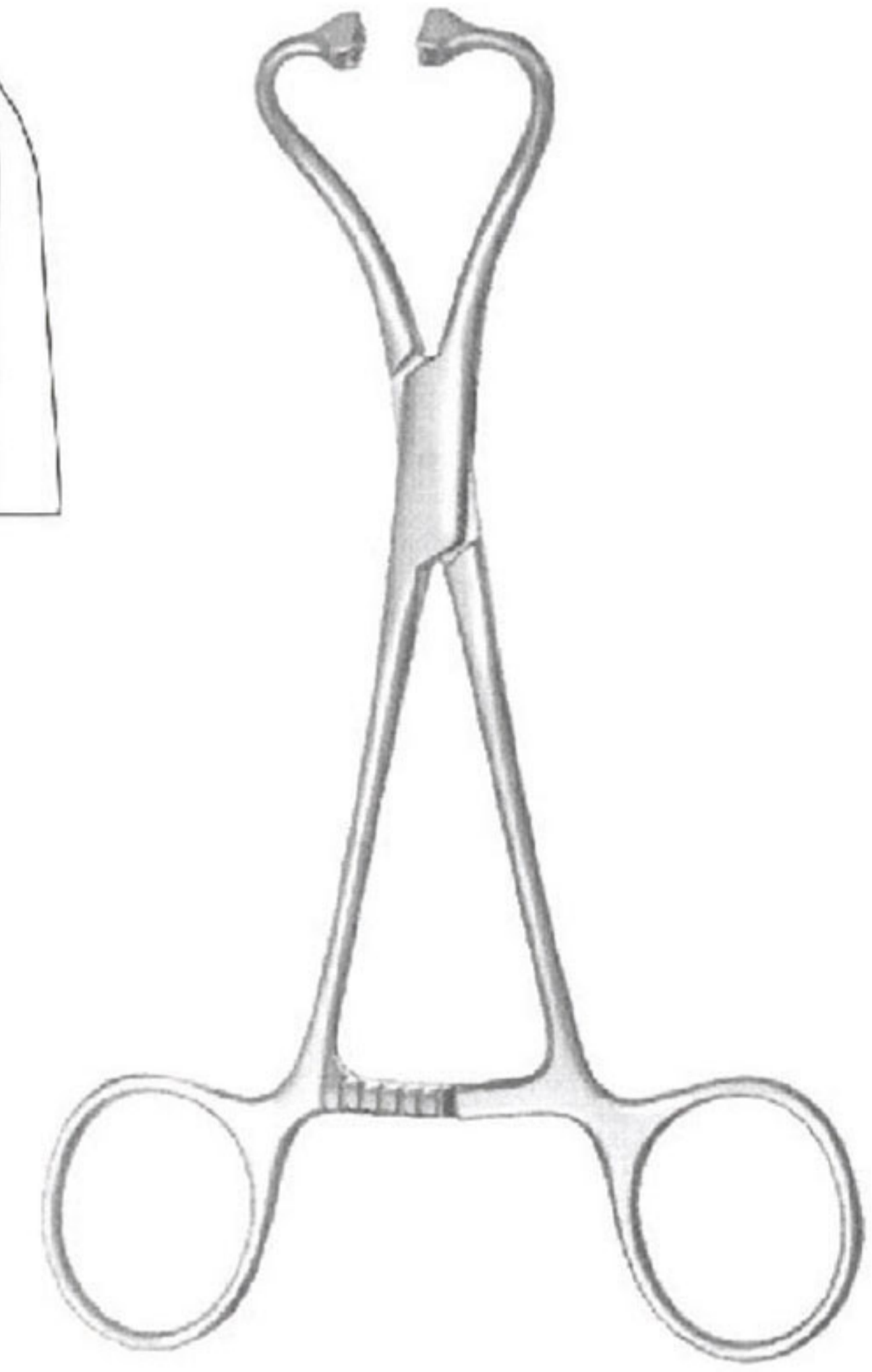
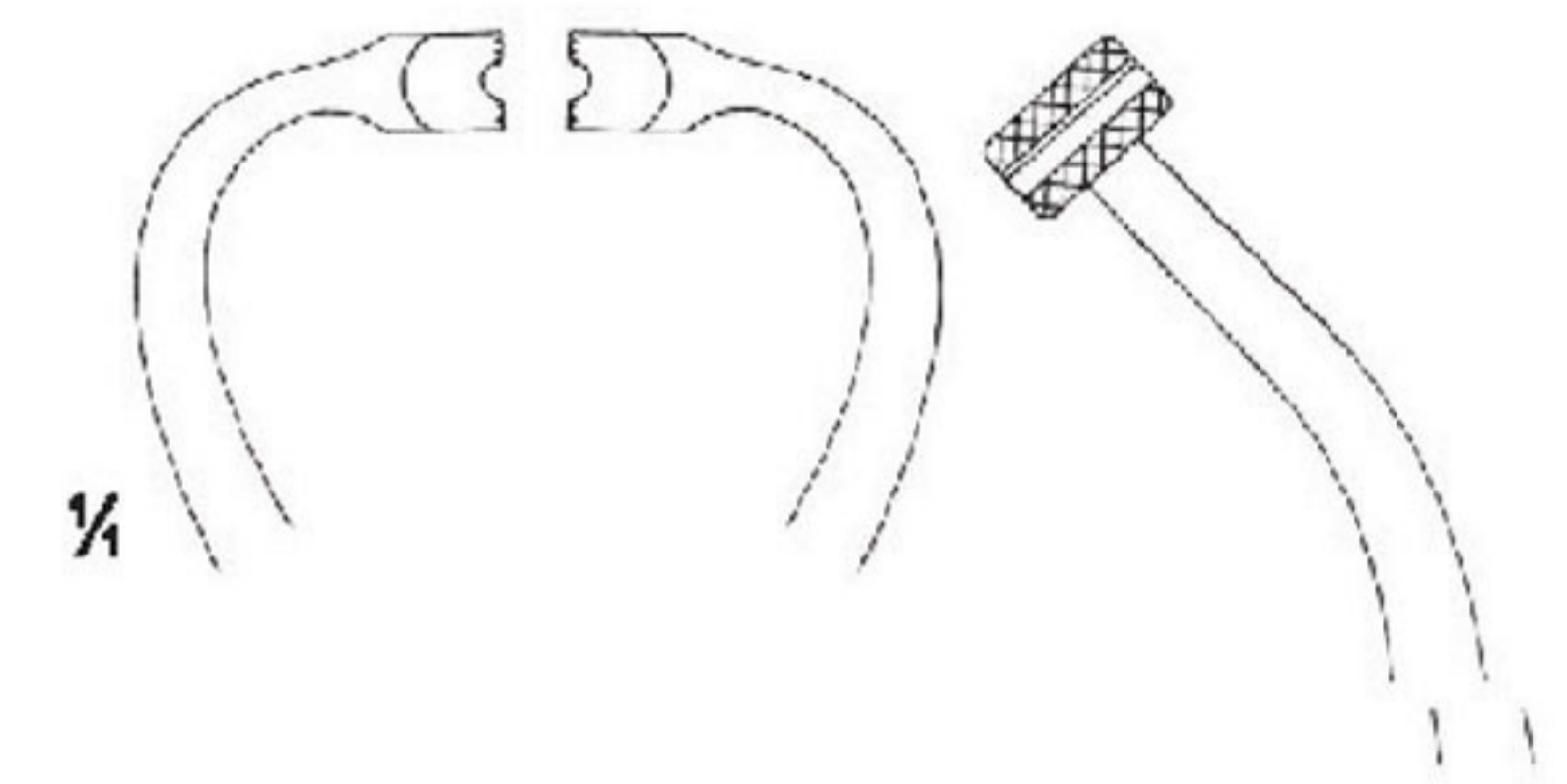
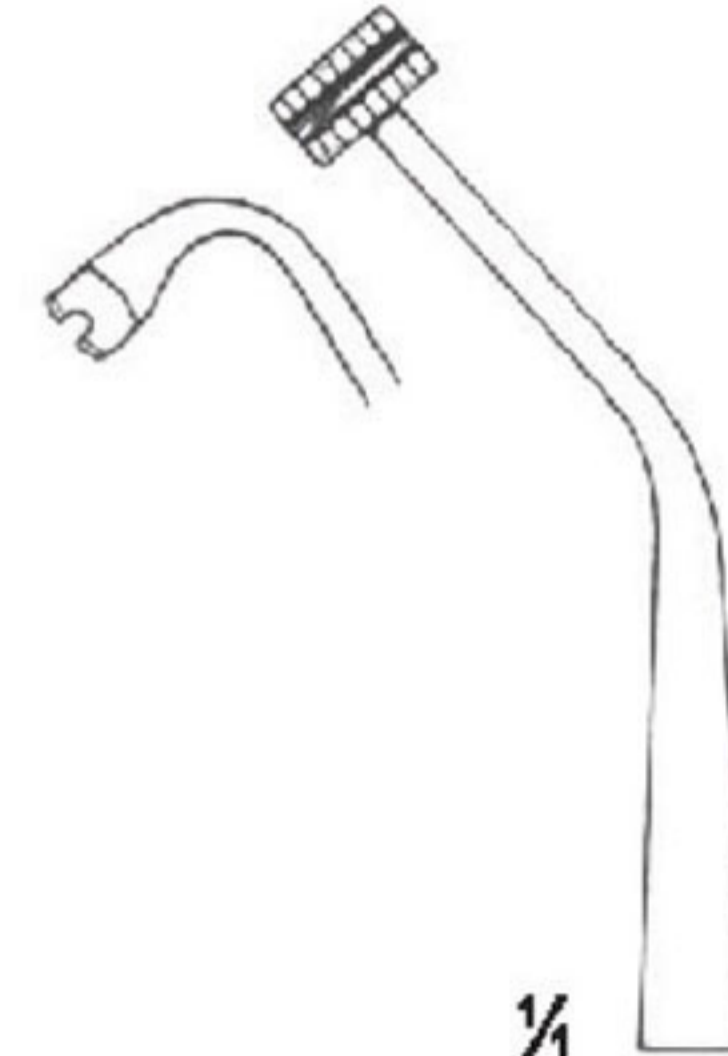

PEERS-BERTRAM MODIF.
OI 11-2751-15 15.5 cm/6 1/8"

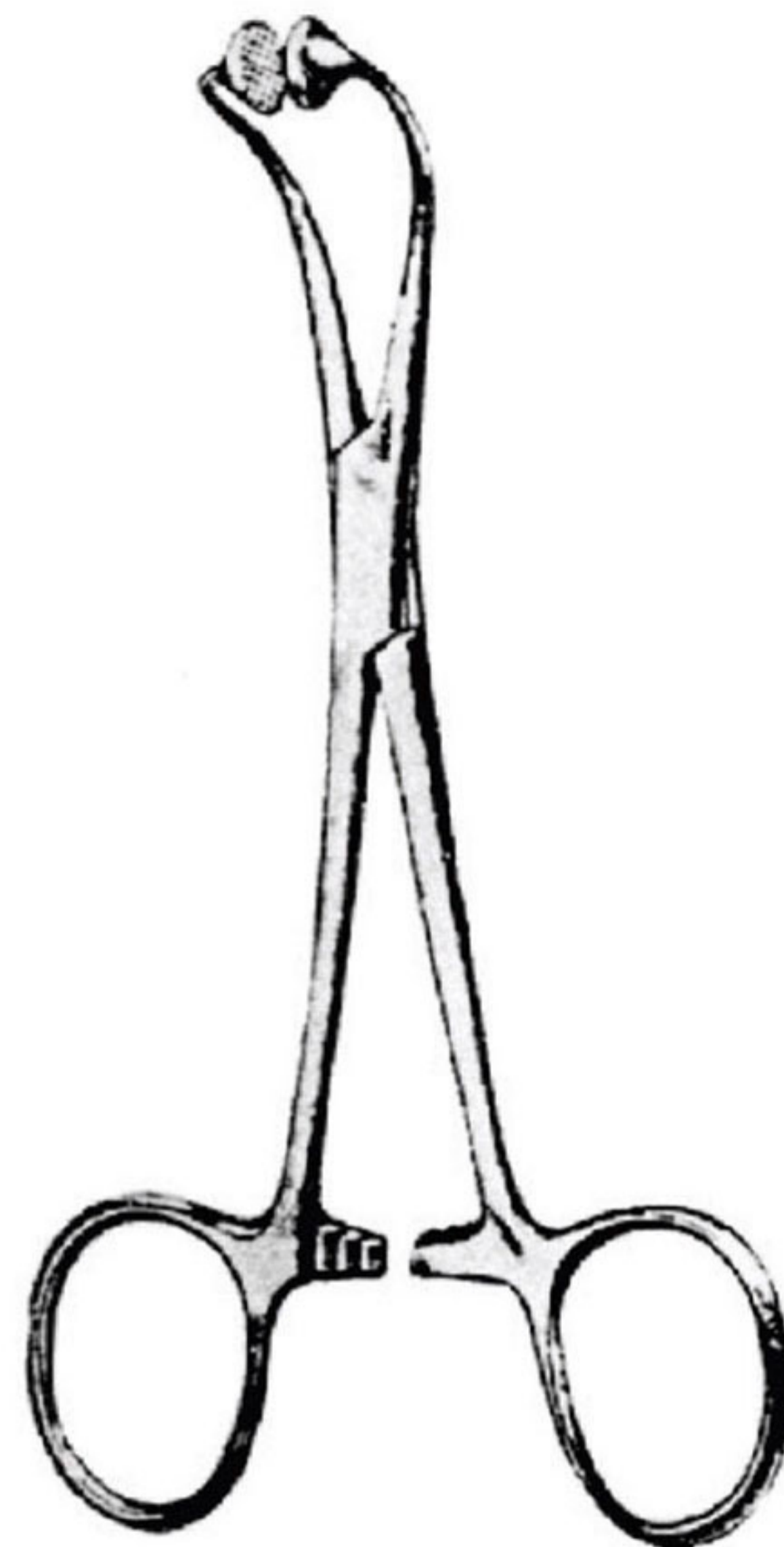

HOFF
OI 11-2752-11 11 cm/4 3/8"
OI 11-2752-14 14.5 cm/5 3/4"



ROBIN
OI 11-2753-13 13.5 cm/5 3/8"
with holder for cable up to 5 mm

1/2



ROBIN
OI 11-2754-13 13.5 cm/5 3/8"
with holder for cable up to 13 mm tubing

1/2

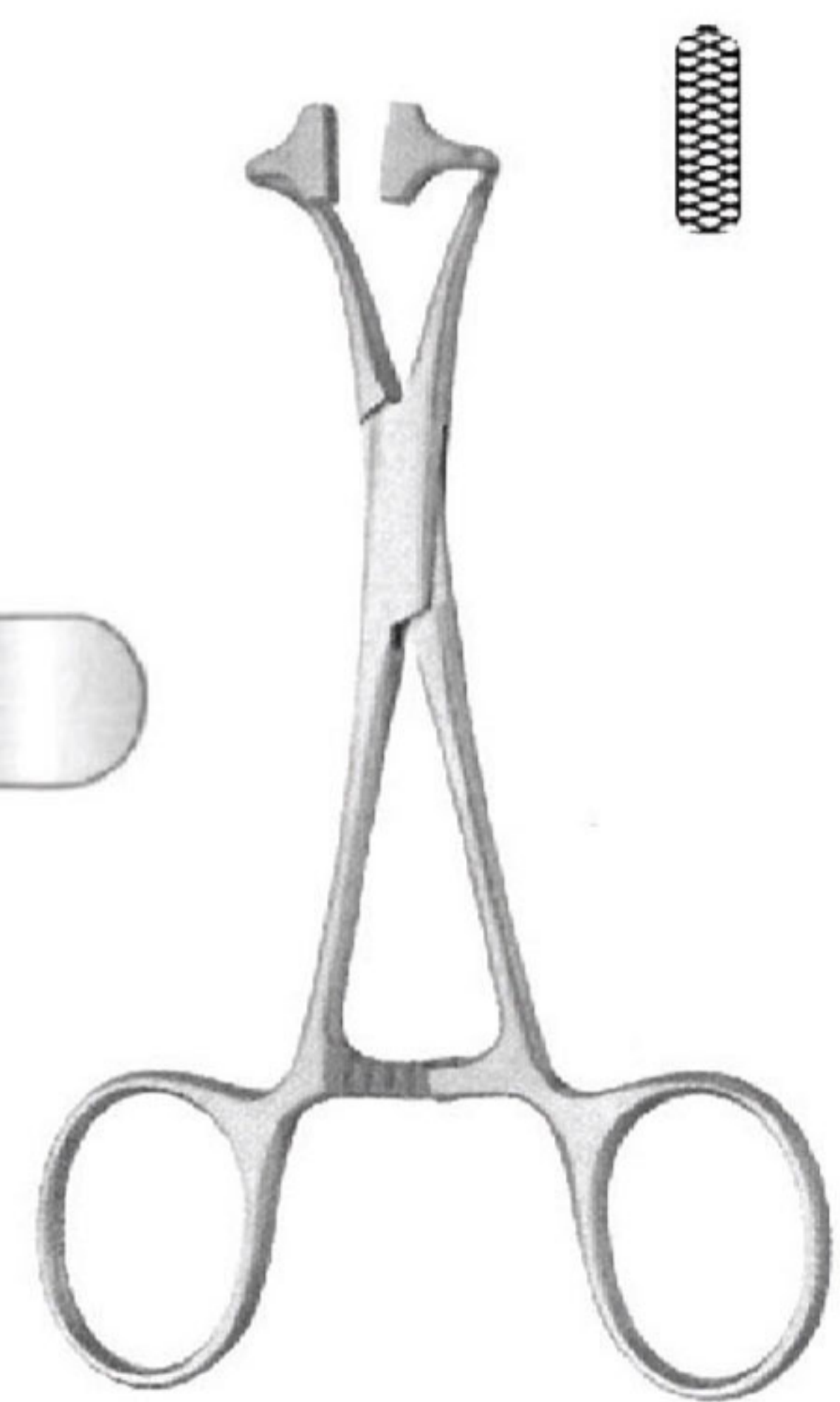

PAPER TOWEL FORCEPS
OI 11-2755-10 10 cm/3 7/8"
OI 11-2755-13 13 cm/5 1/8"

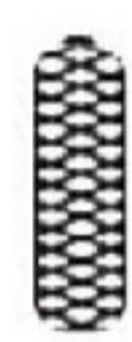

ARTERY FORCEPS



ROEDER
 OI 11-2756-13 13 cm/5 1/8"
 OI 11-2756-15 15 cm/5 7/8"



LORNA
 OI 11-2757-10 10 cm/3 7/8"
 OI 11-2757-13 13 cm/5 1/8"



BERNHARD
 OI 11-2758-16
 16.5 cm/6 1/2"



LANE
 OI 11-2759-20
 20 cm/7 7/8"

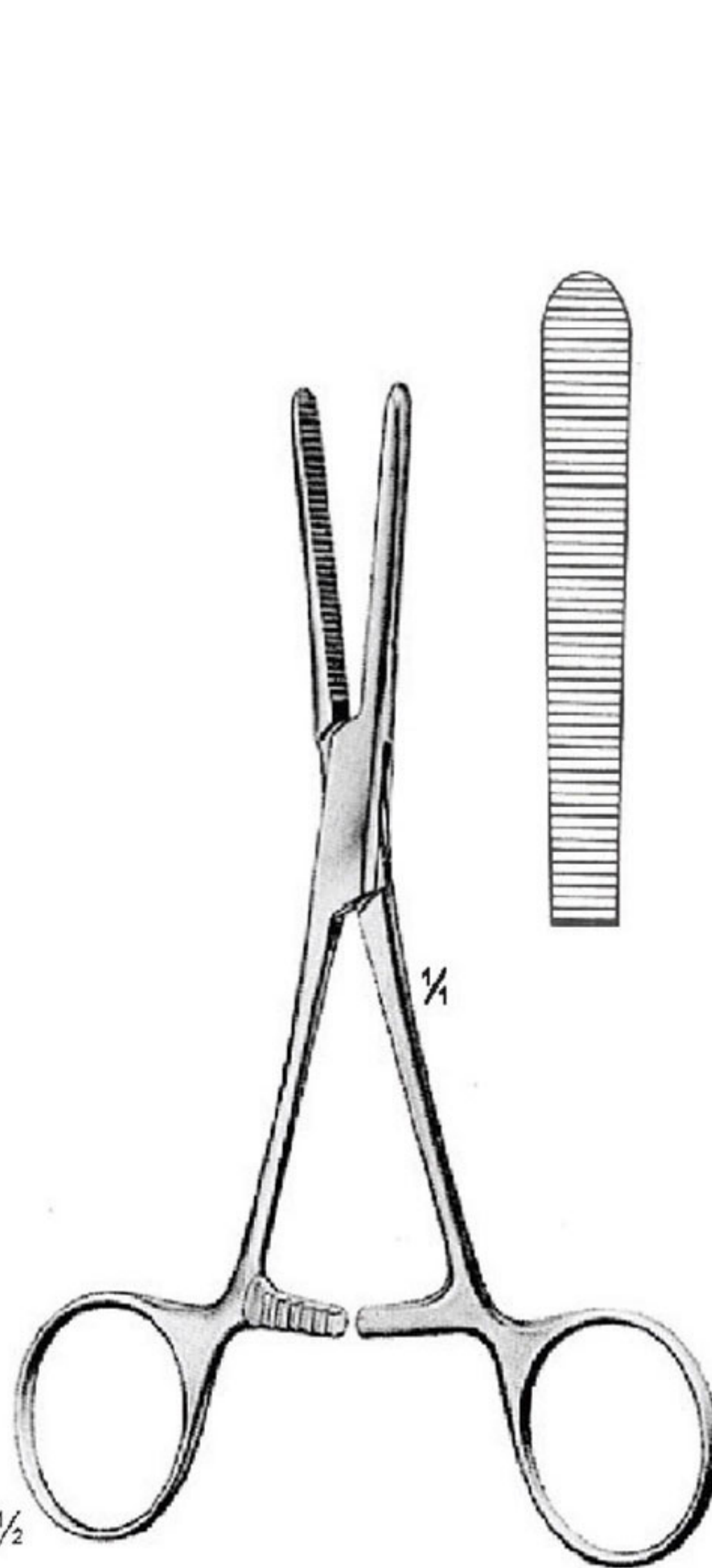
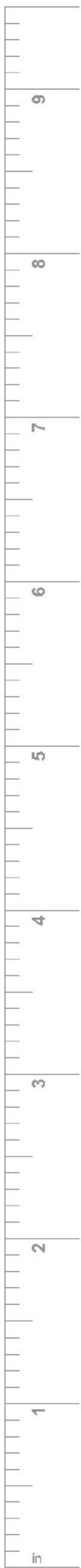

OI 11-2760-14
 14.5 cm/5 3/4"
 with extra long ratchet

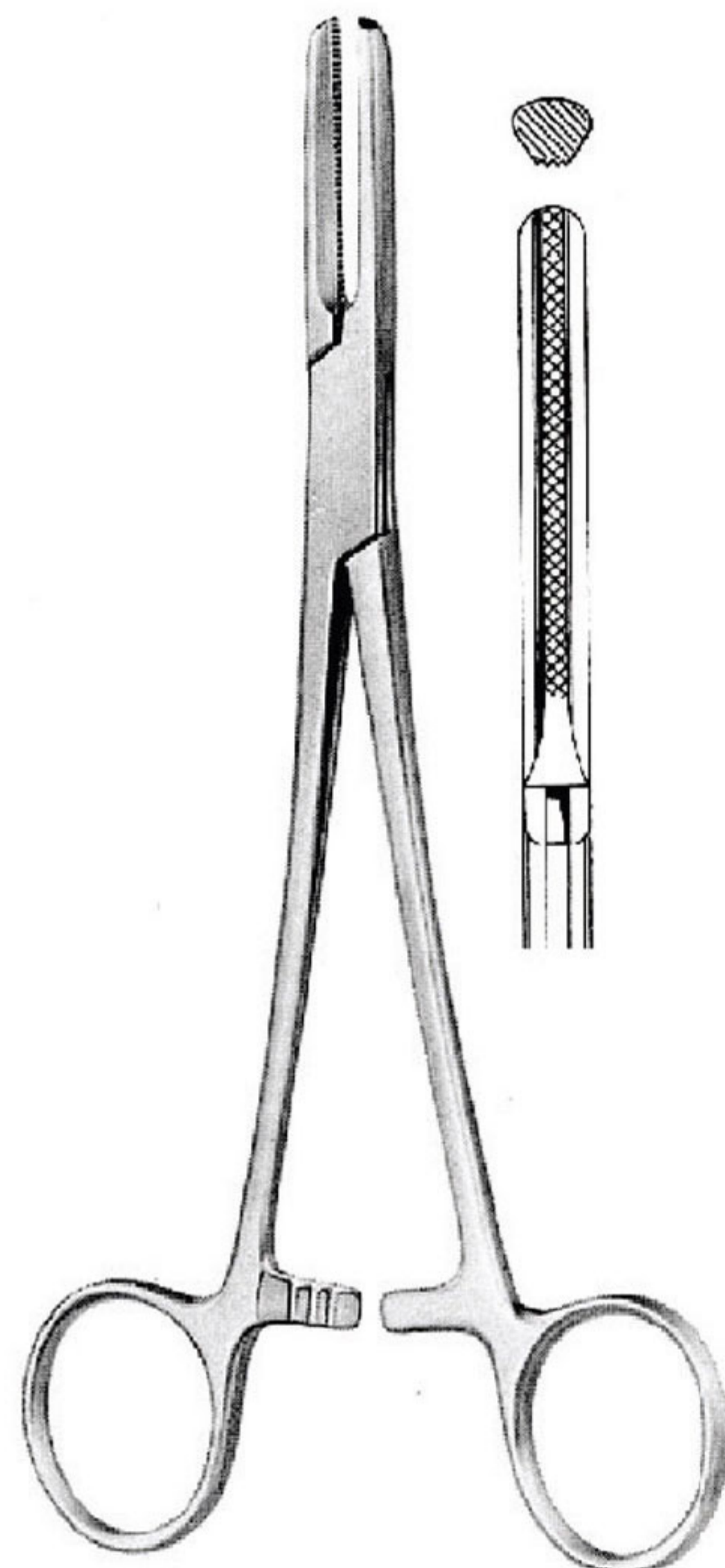

SCHOENBERG
 OI 11-2761-15 15.5 cm/6 1/8"
 OI 11-2761-19 19 cm/7 1/2"
 OI 11-2761-20 20 cm/7 7/8"



SCHOENBERG
 OI 11-2762-15 15.5 cm/6 1/8"
 OI 11-2762-19 19 cm/7 1/2"
 OI 11-2762-20 20 cm/7 7/8"
 with safety guard

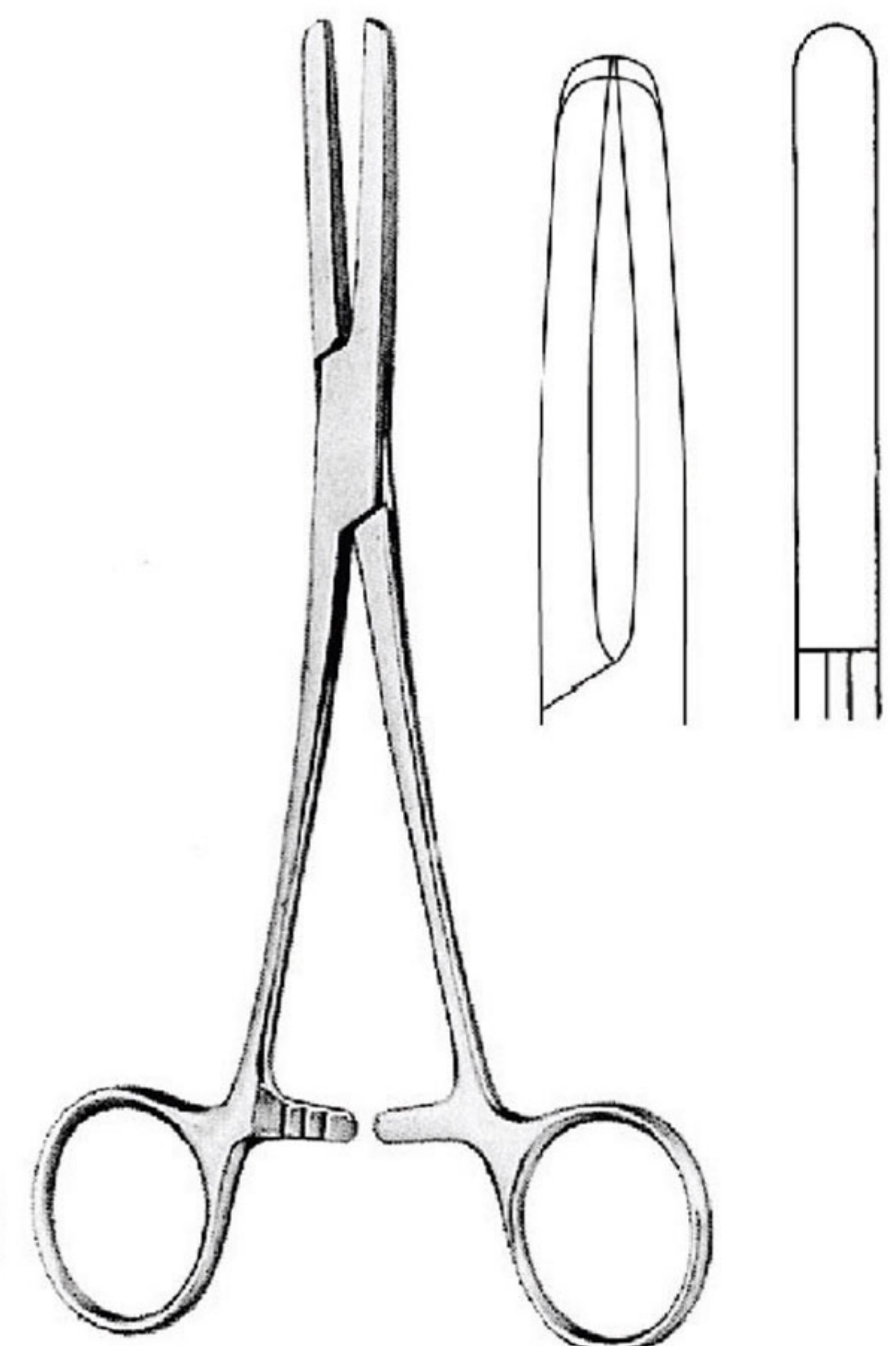

PRESBYTERIAN-HOSPITAL
 OI 11-2763-15 15.5 cm/6 1/8"
 OI 11-2763-19 19 cm/7 1/2"
 OI 11-2763-20 20 cm/7 7/8"



LISTER
OI 11-2764-20
20 cm / 7 7/8"



OI 11-2764-13
13 cm / 5 1/8"



OI 11-2764-15
15 cm / 5 7/8"



OI 11-2764-18
18 cm / 7 1/8"

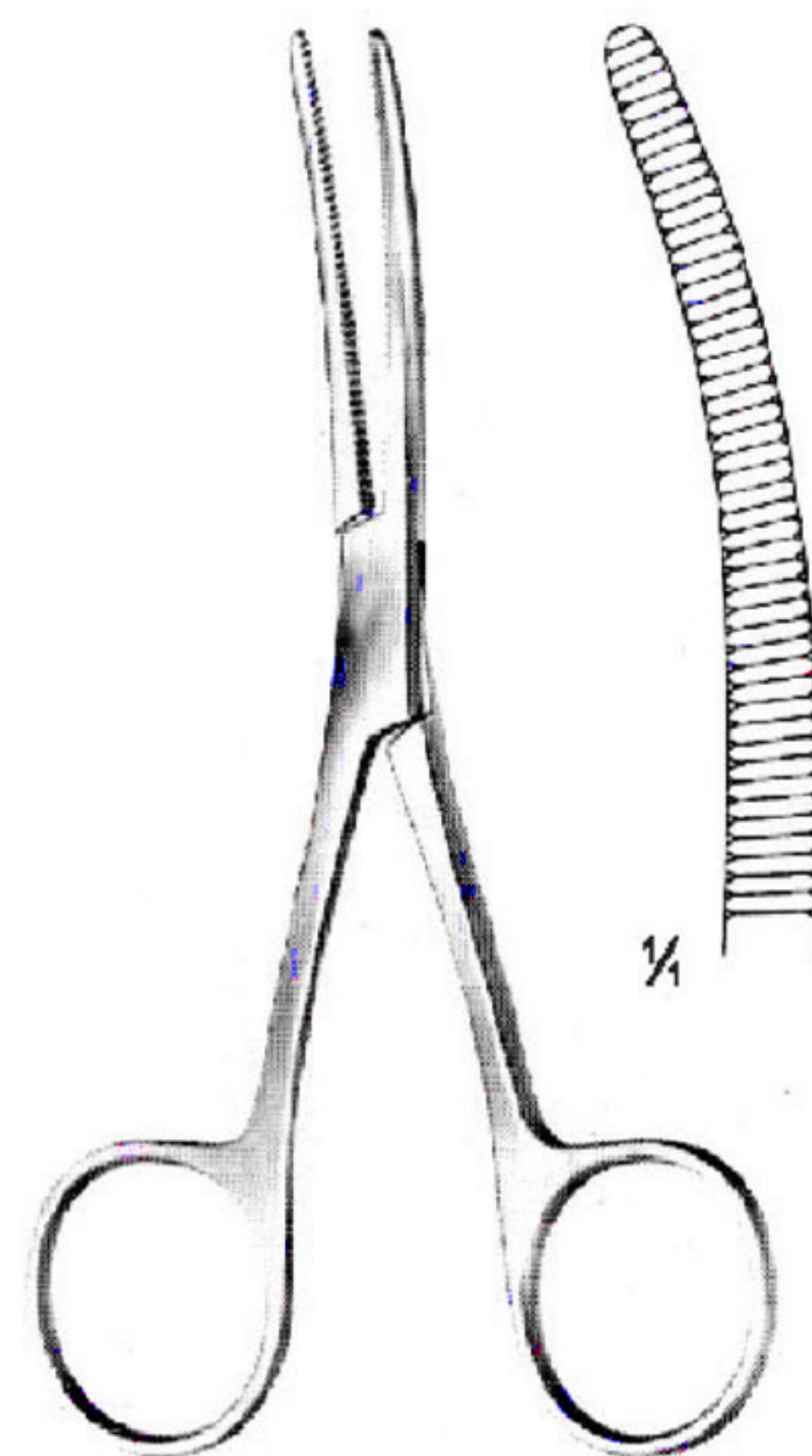

BRYANT
OI 11-2765-13
13 cm / 5 1/8"