

Patient Return Plate (Reusable)

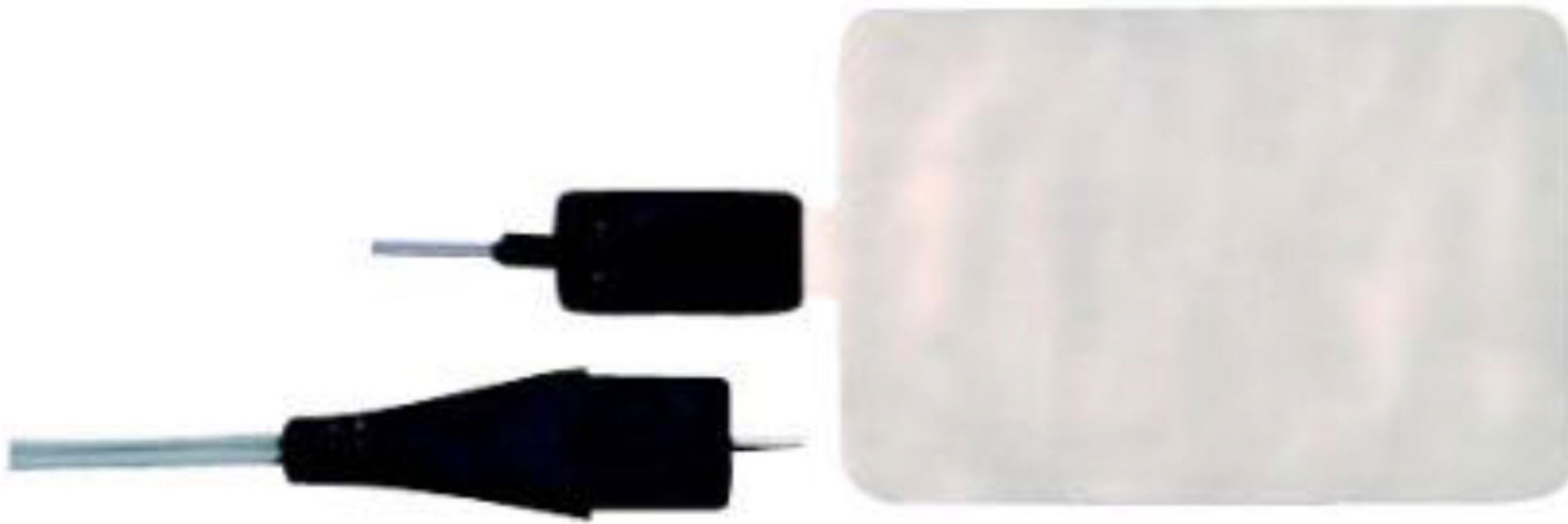

LC - 150-640 5 m Cable



LC - 150-650 5 m Cable

S.S. Patient Return Plate



LC - 150-655

Lateral Vaginal Retractor



LC - 130-120 : Insulated

Kogan Endocervical Speculum



LC - 130-133 3mm

Kogan Endocervical Speculum



LC - 130-134 4 mm



LC - 130-135 5 mm

Polypectomy Snare (Single Use)



LC - 150-500

Holster

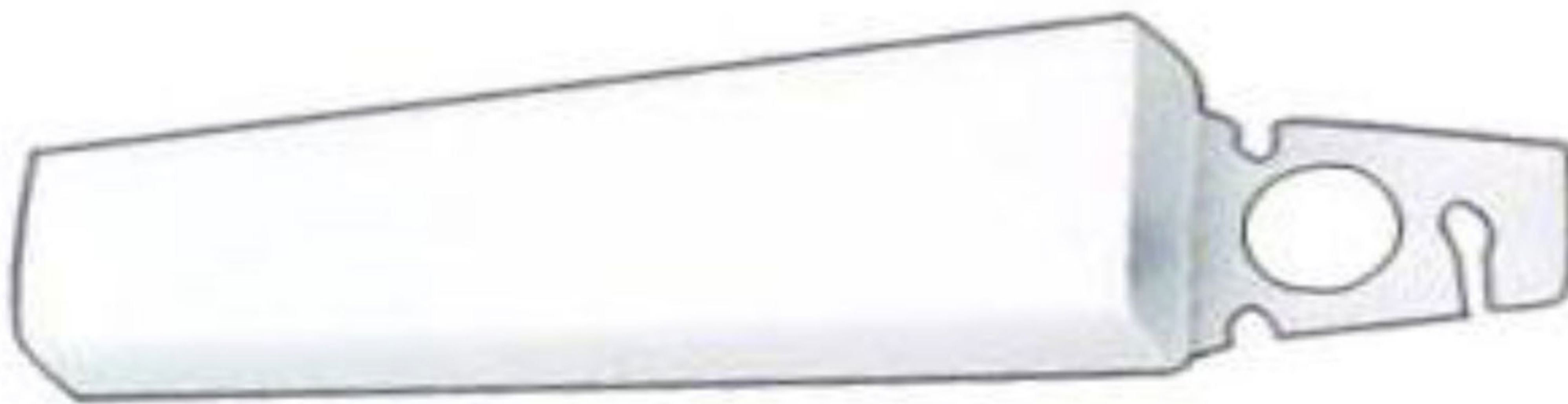

LC - 150-108

Tip Cleaner



LC - 150-109

Square Loop Electrode(Insulated)



13.0 cm length with tip (1.0x0.4cm)

LC - 150-170 -04 2.4 mm



13.0 cm length with tip (1.0x0.5cm)

LC - 150-170 -05 2.4 mm



13.0 cm length with tip (1.0x0.7cm)

LC - 150-170 -07 2.4 mm

Square Loop Electrode (Insulated)



13.0 cm length with tip (1.0x0.8cm)

LC - 150-170 -08 2.4 mm



13.0 cm length with tip (1.0x1.0cm)

LC - 150-170 -10 2.4 mm

Loop Electrode (Insulated)



13.0 cm length with tip (1.0x0.5cm)

LC - 150-175 -05 2.4 mm



13.0 cm length with tip (1.0x0.7cm)

LC - 150-175 -07 2.4 mm



13.0 cm length with tip (1.0x0.8cm)

LC - 150-175 -08 2.4 mm

Loop Electrode (Insulated)



13.0 cm length with tip (1.0x1.0cm)

LC - 150-175 -10 2.4 mm



13.0 cm length with tip (1.0x1.5cm)

LC - 150-175 -15 2.4 mm

Half Round Electrode (Insulated)



13.0 cm length with tip (1.5x0.5cm)

LC - 150-180-05 2.4 mm



13.0 cm length with tip (1.5x0.7cm)

LC - 150-180-07 2.4 mm



13.0 cm length with tip (1.5x0.8cm)

LC - 150-180-08 2.4 mm

Half Round Electrode (Insulated)



13.0 cm length with tip (1.5x1.0cm)

LC - 150-180-10 2.4 mm

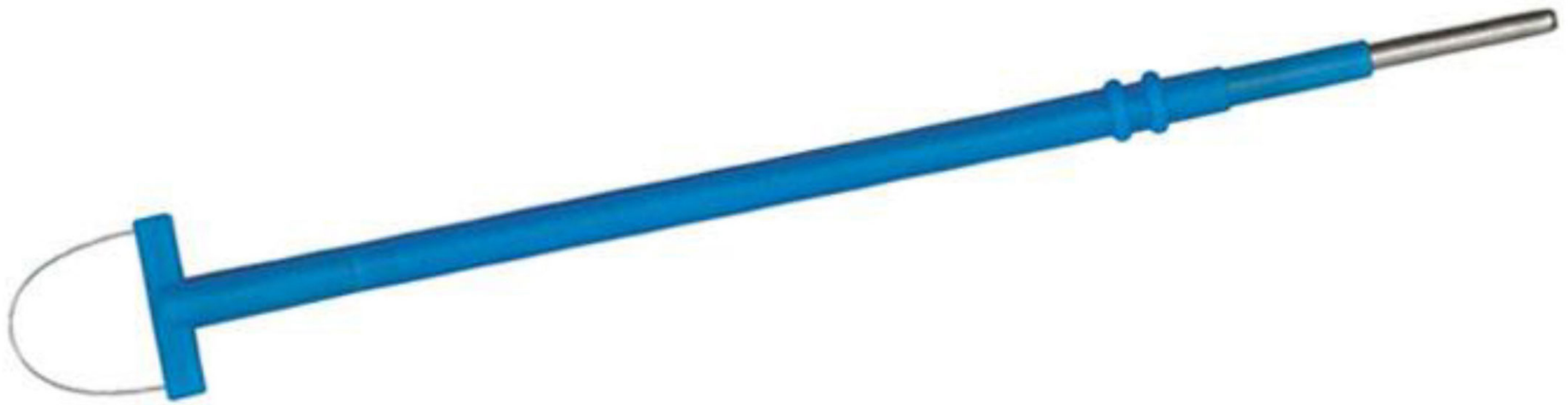

13.0 cm length with tip (1.5x1.2cm)

LC - 150-180-12 2.4 mm



13.0 cm length with tip (1.5x1.5cm)

LC - 150-180-15 2.4 mm

Large Half Round Electrode (Insulated)



13.0 cm length with tip (2.0x0.8cm)

LC - 150-190-08 2.4 mm



13.0 cm length with tip (2.0x1.0cm)

LC - 150-190-10 2.4 mm



13.0 cm length with tip (2.0x1.2cm)

LC - 150-190-12 2.4 mm

Large Half Round Electrode (Insulated)



13.0 cm length with tip (2.0x1.3cm)

LC - 150-190-13 2.4 mm



13.0 cm length with tip (2.0x1.5cm)

LC - 150-190-15 2.4 mm



13.0 cm length with tip (2.0x2.0cm)

LC - 150-190-20 2.4 mm

Ball Electrode (Insulated)



Straight Shafts with 7.0 cm length

LC - 150-110 2.4 mm



Curved Shafts with 7.0 cm length

LC - 150-112 2.4 mm



Straight Shafts with 7.0 cm length

LC - 150-120 2.4 mm



Curved Shafts with 7.0 cm length

LC - 150-122 2.4 mm

Ball Electrode (Insulated)



Straight Shafts with 2 mm tip, 7.0 cm length

LC - 150-130 2.4 mm



Curved Shafts with 2 mm tip, 7.0 cm length

LC - 150-132 2.4 mm



Straight Shafts with 3mm tip, 7.0 cm length

LC - 150-140 2.4 mm



Curved Shafts with 3mm tip, 7.0 cm length

LC - 150-142 2.4 mm

Ball Electrode (Insulated)



Straight Shafts with 4 mm tip, 7.0 cm length LC - 150-150 2.4 mm



Curved Shafts with 4 mm tip, 7.0 cm length LC - 150-152 2.4 mm



Straight Shafts with 5 mm tip, 7.0 cm length LC - 150-160 2.4 mm



Curved Shafts with 5 mm tip, 7.0 cm length LC - 150-162 2.4 mm

Blade Electrode (Insulated)



Shafts with 13.0cm length

LC - 150-115 2.4 mm



Shafts with 13.0cm length

LC - 150-125 2.4 mm



13.0 cm length with tip 3 mm

LC - 150-145 2.4 mm

Blade Electrode (Insulated)



13.0 cm length with tip 5 mm

LC - 150-165 2.4 mm

Conization Electrode (Insulated)



Shafts with 13.0 cm length

LC - 150-195 2.4 mm

Square Loop Electrode (Insulated)



13.0 cm long with tip Size (1.0x0.4cm)

LC - 152-170 -04 2.4 mm
LC - 162-170 -04 4.0 mm



13.0 cm long with tip Size (1.0x0.5cm)

LC - 152-170 -05 2.4 mm
LC - 162-170 -05 4.0 mm

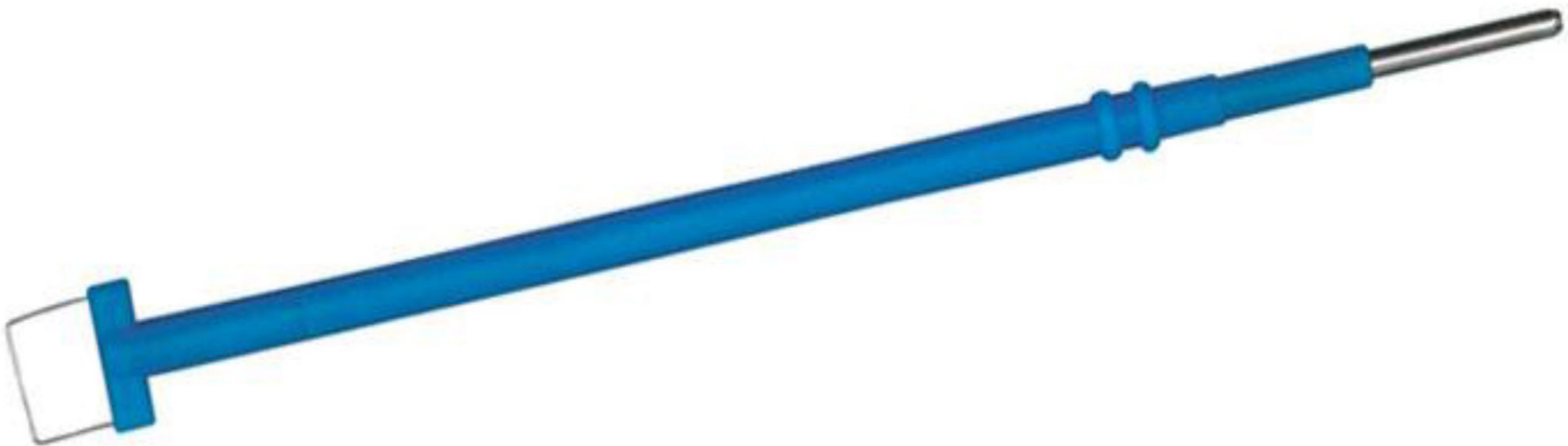

13.0 cm long with tip Size (1.0x0.7cm)

LC - 152-170 -07 2.4 mm
LC - 162-170 -07 4.0 mm

Square Loop Electrode (Insulated)



13.0 cm long with tip Size (1.0x0.8cm)

LC - 152-170 -08 2.4 mm
LC - 162-170 -08 4.0 mm



13.0 cm long with tip Size (1.0x1.0cm)

LC - 152-170 -10 2.4 mm
LC - 162-170 -10 4.0 mm

Loop Electrode (Insulated)



13.0 cm long with tip Size (1.0x0.5cm)

LC - 152-175 -05 2.4 mm
LC - 162-175 -05 4.0 mm



13.0 cm long with tip Size (1.0x0.7cm)

LC - 152-175 -07 2.4 mm
LC - 162-175 -07 4.0 mm



13.0 cm long with tip Size (1.0x0.8cm)

LC - 152-175 -08 2.4 mm
LC - 162-175 -08 4.0 mm

Loop Electrode (Insulated)



13.0 cm long with tip Size (1.0x1.0cm)

LC - 152-175 -10 2.4 mm
LC - 162-175 -10 4.0 mm



13.0 cm long with tip Size (1.0x1.5cm)

LC - 152-175 -15 2.4 mm
LC - 162-175 -15 4.0 mm

Half Round Electrode(Insulated)



13.0 cm long with tip Size (1.5x0.5cm)

LC - 152-180-05 2.4 mm
LC - 162-180 -05 4.0 mm



13.0 cm long with tip Size (1.5x0.7cm)

LC - 152-180-07 2.4 mm
LC - 162-180 -07 4.0 mm



13.0 cm long with tip Size (1.5x0.8cm)

LC - 152-180-08 2.4 mm
LC - 162-180 -08 4.0 mm

Half Round Electrode (Insulated)



13.0 cm long with tip Size (1.5x1.0cm)

LC - 152-180-10 2.4 mm
LC - 162-180 -10 4.0 mm



13.0 cm long with tip Size (1.5x1.2cm)

LC - 152-180-12 2.4 mm
LC - 162-180 -12 4.0 mm



13.0 cm long with tip Size (1.5x1.5cm)

LC - 152-180-15 2.4 mm
LC - 162-180 -15 4.0 mm

Large Half Round Electrode (Insulated)



13.0 cm long with tip Size (2.0x0.8cm)

**LC - 152-190-08 2.4 mm
LC - 162-190 -08 4.0 mm**



13.0 cm long with tip Size (2.0x1.0cm)

**LC - 152-190-10 2.4 mm
LC - 162-190 -10 4.0 mm**



13.0 cm long with tip Size (2.0x1.2cm)

**LC - 152-190-12 2.4 mm
LC - 162-190 -12 4.0 mm**

Large Half Round Electrode(Insulated)



13.0 cm long with tip Size (2.0x1.3cm)

**LC - 152-190-13 2.4 mm
LC - 162-190 -13 4.0 mm**



13.0 cm long with tip Size (2.0x1.5cm)

**LC - 152-190-15 2.4 mm
LC - 162-190 -15 4.0 mm**



13.0 cm long with tip Size (2.0x2.0cm)

**LC - 152-190-20 2.4 mm
LC - 162-190 -20 4.0 mm**

Conization Electrode (Insulated)



LC - 152-195 13.0 cm

Ball Electrode(Insulated)



Straight Shafts with 7.0 cm length

LC - 152-110 2.4 mm

LC - 162-110 4.0mm



Curved Shafts with 7.0 cm length

LC - 152-112 2.4 mm

LC - 162-112 4.0mm

Ball Electrode (Insulated)



LC - 152-120 2.4 mm
LC - 162-120 4.0mm

Straight Shafts with 7.0 cm length



LC - 152-122 2.4 mm
LC - 162-122 4.0mm

Curved Shafts with 7.0 cm length



Straight Shafts with 2 mm tip, 7.0 cm length

LC - 152-130 2.4 mm
LC - 162-130 4.0mm

Ball Electrode (Insulated)



Curved Shafts with 2 mm tip, 70. cm length

LC - 152-132 2.4 mm
LC - 162-132 4.0mm



Straight Shafts with 3 mm tip, 7.0 cm length

LC - 152-140 2.4 mm
LC - 162-140 4.0mm



Curved Shafts with 3 mm tip, 7.0 cm length

LC - 152-142 2.4 mm
LC - 162-142 4.0mm

Ball Electrode (Insulated)



Straight Shafts with 4 mm tip, 7.0 cm length

**LC - 152-150 2.4 mm
LC - 162-150 4.0mm**



Curved Shafts with 4 mm tip, 7.0 cm length

**LC - 152-152 2.4 mm
LC - 162-152 4.0mm**



Straight Shafts with 5 mm tip, 7.0 cm length

**LC - 152-160 2.4 mm
LC - 162-160 4.0mm**

Ball Electrode (Insulated)



Curved Shafts with 5 mm tip, 7.0 cm length

LC - 152-162 2.4 mm
LC - 162-162 4.0mm

Blade Electrode (Insulated)



Shafts with 13.0cm length

LC - 152-115 2.4 mm
LC - 162-115 4.0 mm



Shafts with 13.0cm length

LC - 152-125 2.4 mm
LC - 162-125 4.0 mm

Blade Electrode (Insulated)



13.0 cm length with tip 3 mm

LC - 152-145 2.4 mm
LC - 162-145 4.0 mm



13.0 cm length with tip 5 mm

LC - 152-165 2.4 mm
LC - 162-165 4.0 mm

Circle Loop Electrode (Insulated)



7.0 cm length with tip 4.0 mm

LC - 152-510 2.4 mm
LC - 162-510-04 4.0 mm



7.0 cm length with tip 6.0 mm

LC - 152-520 2.4 mm
LC - 162-510-06 4.0 mm



7.0 cm length with tip 8.0 mm

LC - 152-530 2.4 mm
LC - 162-510-08 4.0 mm

Circle Loop Electrode (Insulated)



7.0 cm length with tip 10.0 mm

LC - 162-510-10 4.0 mm

Diamond Loop Electrode (Insulated)



LC - 152-540 2.4 mm

Fine Needle Electrodes (Insulated)



LC - 152-550 2.4 mm

Plate Electrode



LC - 162-560

Small

LC - 162-570

Large

Graves Vaginal Speculum



Large	LC - 130-100	: Insulated
Medium	LC -130-102	: Insulated
Small	LC -130-103	: Insulated

with Smoke Evacuation tube

Pederson Vaginal Speculum



Large	LC - 130-200	: Insulated
Medium	LC -130-202	: Insulated
Small	LC -130-203	: Insulated

With Smoke Evacuation tube

Vu-Max



Medium	LC -130-105	: Insulated
Medium	LC -130-115 *	: Insulated

Notes

* Speculum with disposable tubing Pederson

Vu-More (Graves)



Large	LC -130-117	: Insulated
Medium	LC -130-118	: Insulated

Speculum with Disposable Tubing

Cusco



Large	LC - 130-108	: Insulated
Medium	LC -130-109	: Insulated
Small	LC -130-110	: Insulated

Collin Speculum



Large	LC - 130-111	: Insulated
Medium	LC -130-112	: Insulated
Small	LC -130-113	: Insulated

McPherson



Straight Shafts with 0.5 mm tip, 9.0 cm long

LC - 110-100 : Insulated
LC - 120-100 : Non-insulated



Angled Shafts with 0.5 mm tip, 9.0 cm long

LC - 110-110 : Insulated
LC - 120-110 : Non-insulated

Coaptation Nadler



Curved Shafts with 0.5 mm tip, 10.2 cm long

LC - 110-120 : Insulated
LC - 120-120 : Non-insulated

Coaptation



Angled Shafts with 0.5 mm tip, 10.8 cm long

LC - 110-130 : Insulated
LC - 120-130 : Non-insulated

Janson Bayonet



Straight Shafts with 1.5 mm tip, 13.3 cm long

LC - 110-560 : Insulated



Straight Shafts with 1.5 mm tip, 15.9 cm long

LC - 110-570 : Insulated



Curved Shafts with 2.0 mm tip, 19.1 cm long

LC - 110-580 : Insulated



Curved Shafts with 2.0 mm tip, 21.0 cm long

LC - 110-590 : Insulated

Lateral Retractor (Wide Open)



LC - 130-122 : Insulated

Gelpi Retractor



LC - 130-140 : Insulated

Rigby Retractor



LC - 130-150: Insulated

Schroeder Tenaculum



LC - 130-160: Insulated

Campion Forceps Insulated



LC - 130-168 22 cm

Single Tooth Tenaculum Insulated



LC - 130-162 24 cm

Ring Forceps Insulated



LC - 130-165 22 cm

Dressing Forceps Insulated



LC - 130-180 21 cm

LC - 130-181 25 cm

Tissue Forceps Insulated

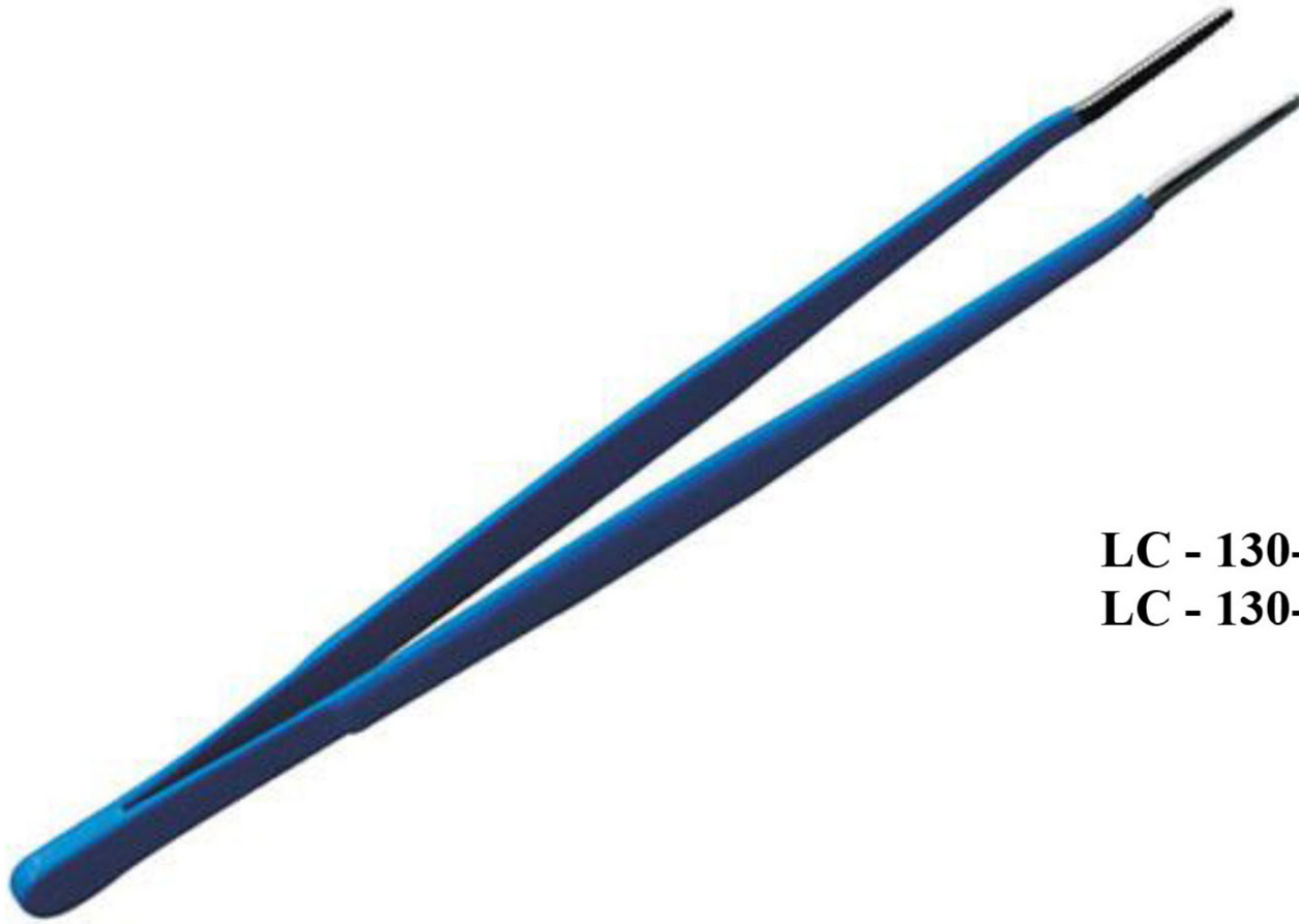

LC - 130-185 21 cm
LC - 130-186 25 cm

Iris Hook Insulated

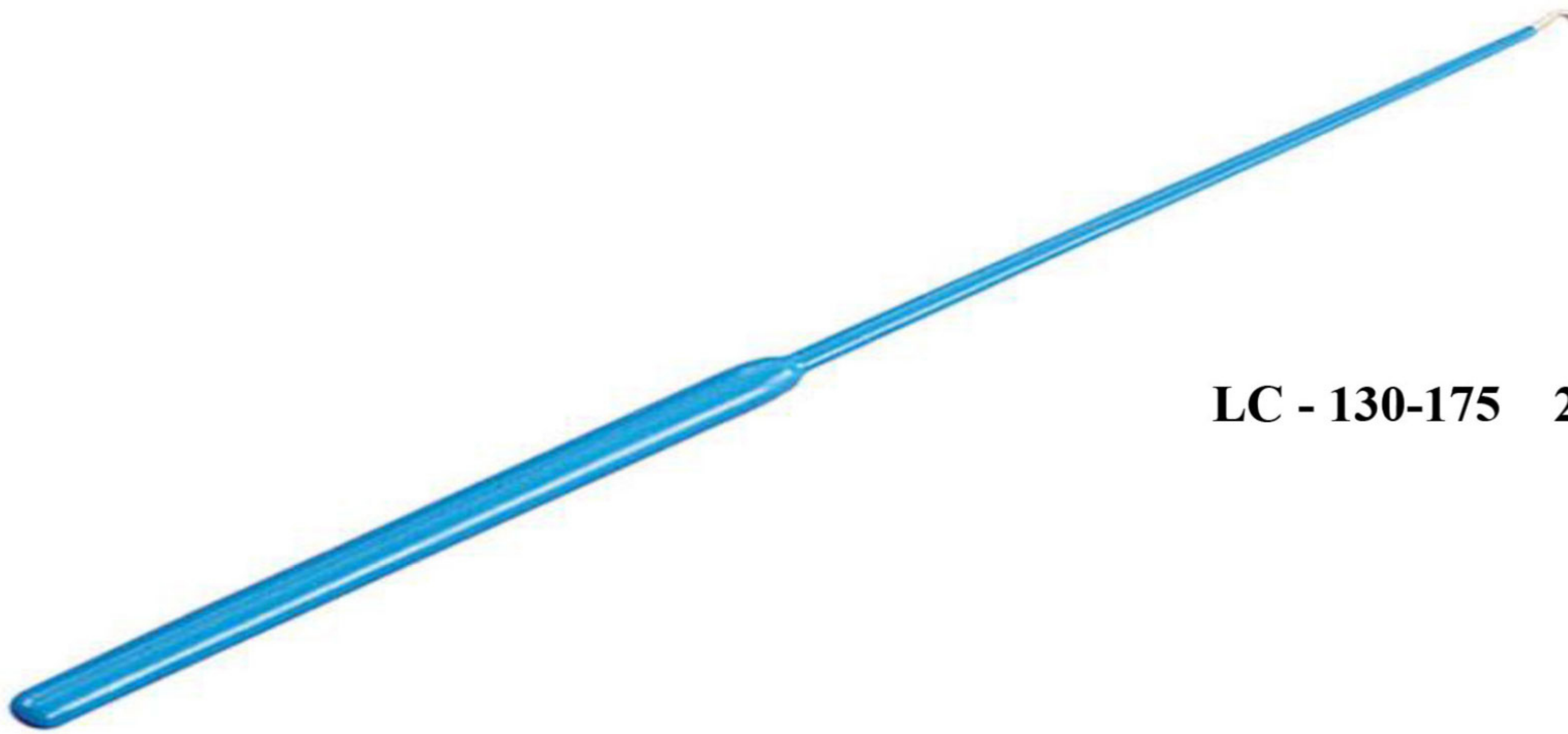

LC - 130-175 25 cm

Emmett Hook Insulated

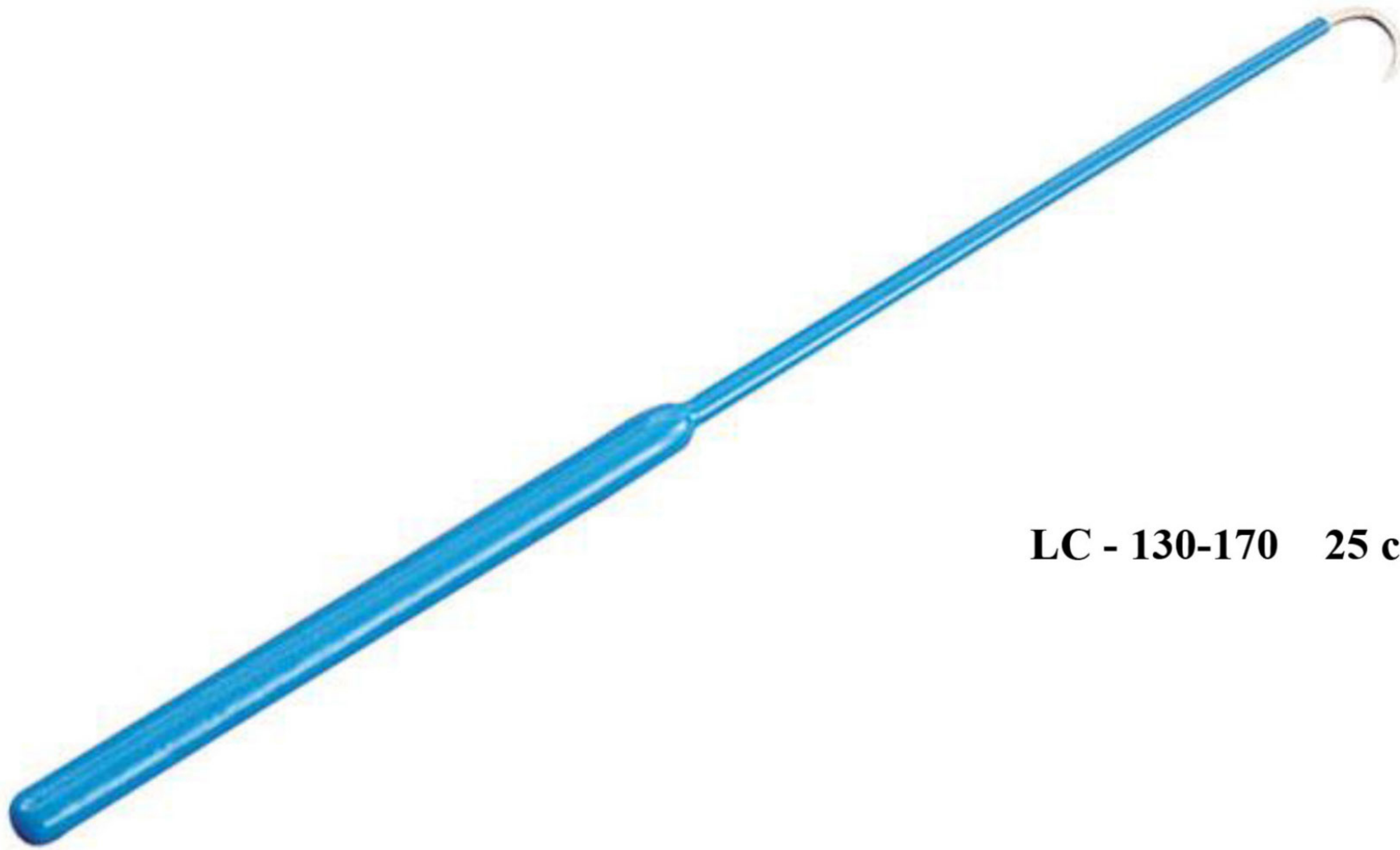

LC - 130-170 25 cm

Straight Hook Insulated

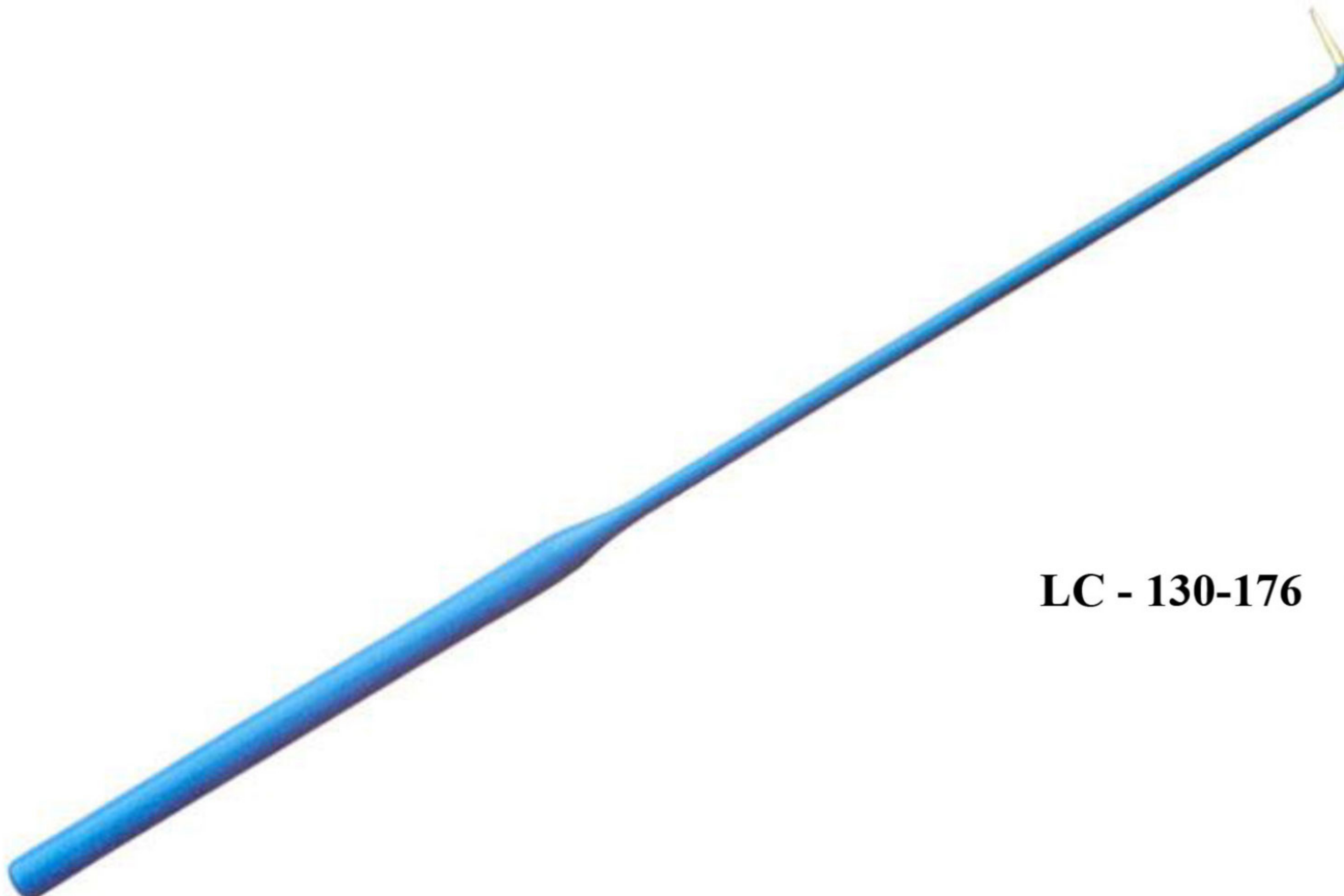

LC - 130-176 25 cm

Two-Prong Hook Insulated

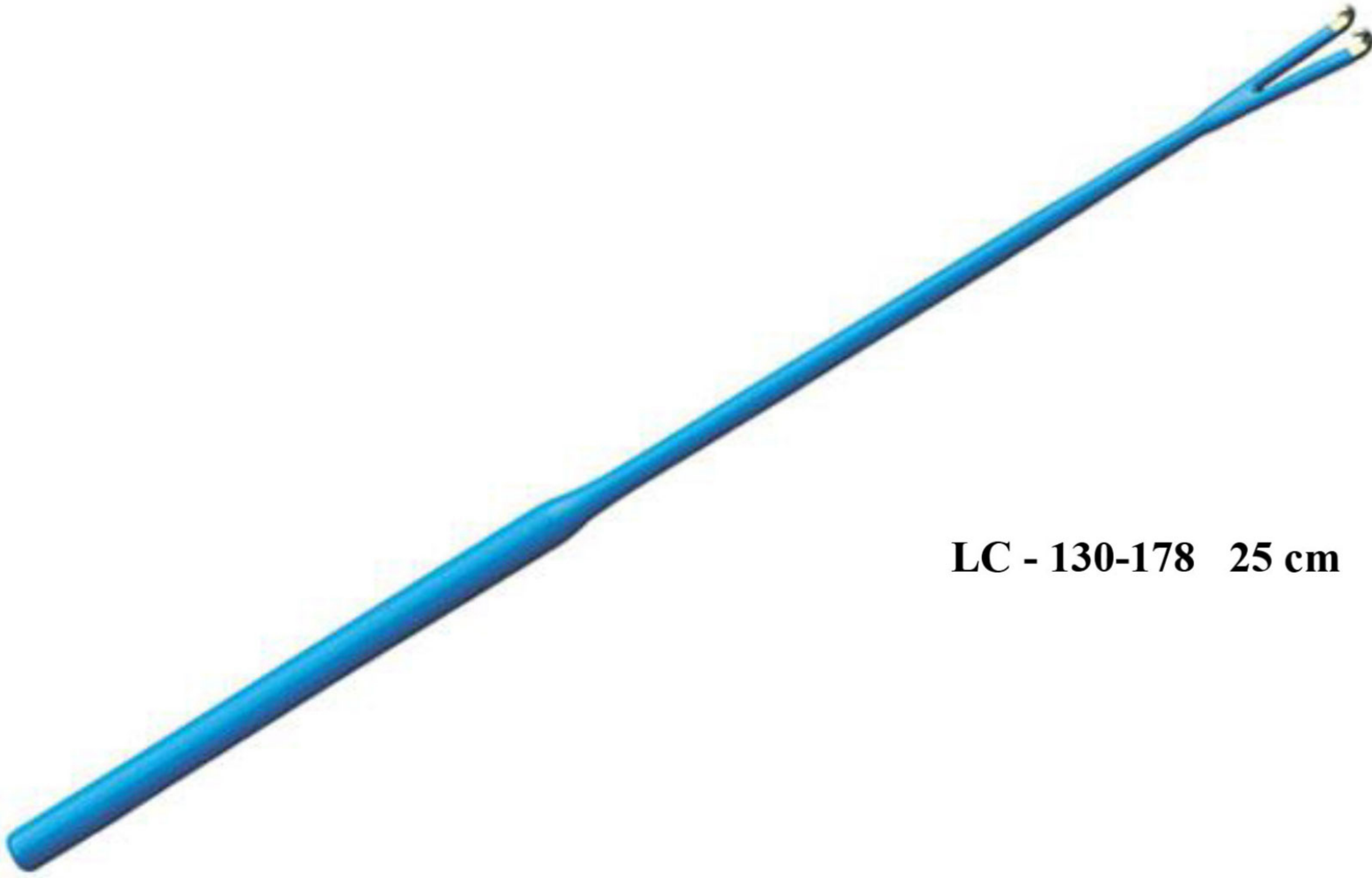

LC - 130-178 25 cm

Three-Prong Hook Insulated

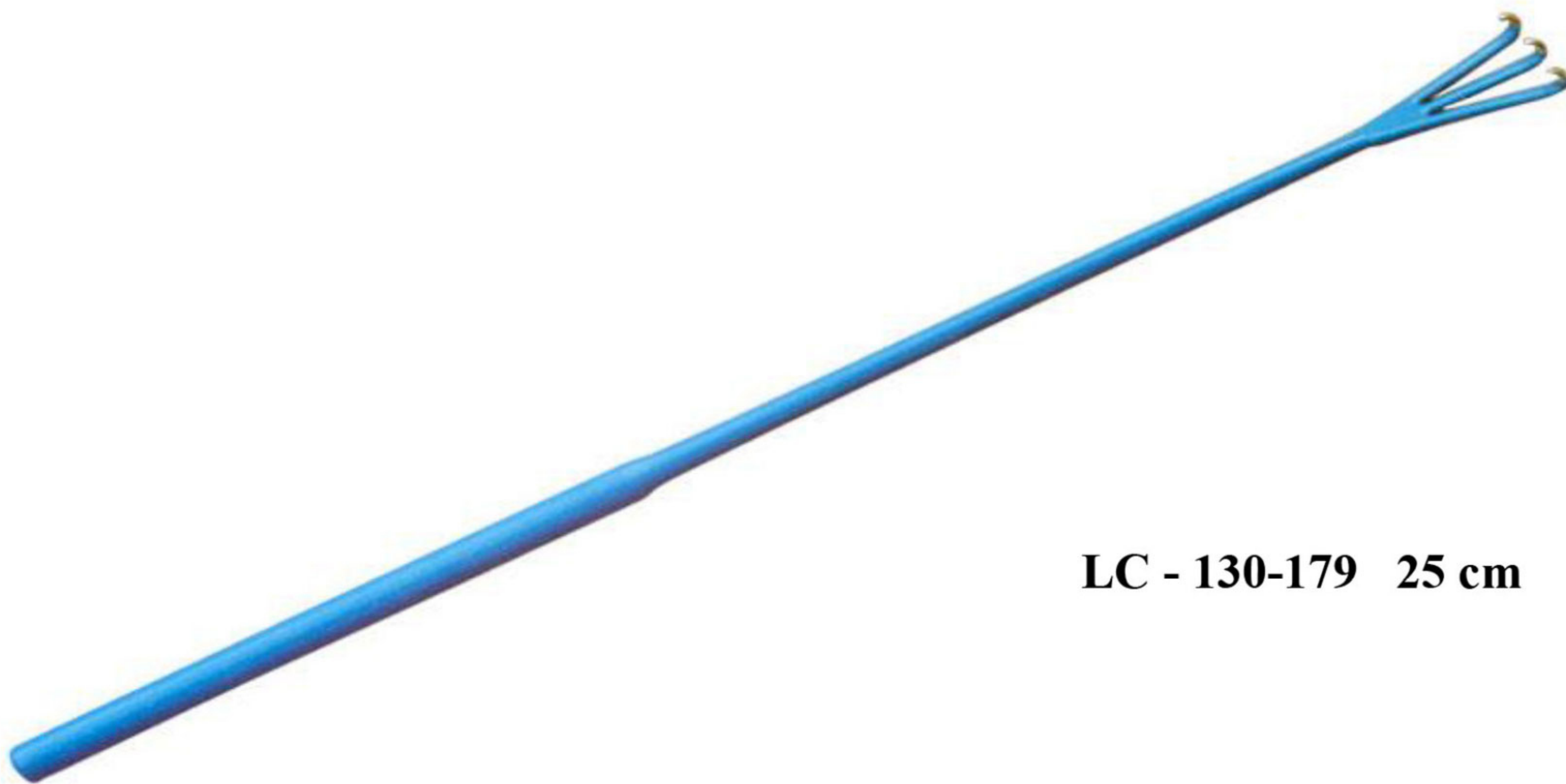

LC - 130-179 25 cm

Weisman Speculum (Left Open)



Large	LC - 130-220	: Insulated
Medium	LC -130-224	: Insulated

Weisman Speculum (Right Open)



Large	LC - 130-221	: Insulated
Medium	LC -130-225	: Insulated

Janson Bayonet



Angled up Shafts with 2.0 mm tip, 19.1 cm long LC - 110-582 : Insulated



Angled up Shafts with 2.0 mm tip, 21.0 cm long LC - 110-592 : Insulated

Graves Vaginal Speculum



Large	LC - 140-100	: Insulated
Medium	LC -140-102	: Insulated
Small	LC -140-103	: Insulated

Pederson Vaginal Speculum



Large	LC - 140-200	: Insulated
Medium	LC -140-202	: Insulated
Small	LC -140-203	: Insulated

Collin Speculum



Large	LC - 140-111	: Insulated
Medium	LC -140-112	: Insulated
Small	LC -140-113	: Insulated

Lateral Vaginal Retractor



LC - 140-120 : Insulated

Kogan Endocervical Speculum



Straight Shafts with 3 mm tip

LC - 140-133 : Insulated

Kogan Endocervical Speculum

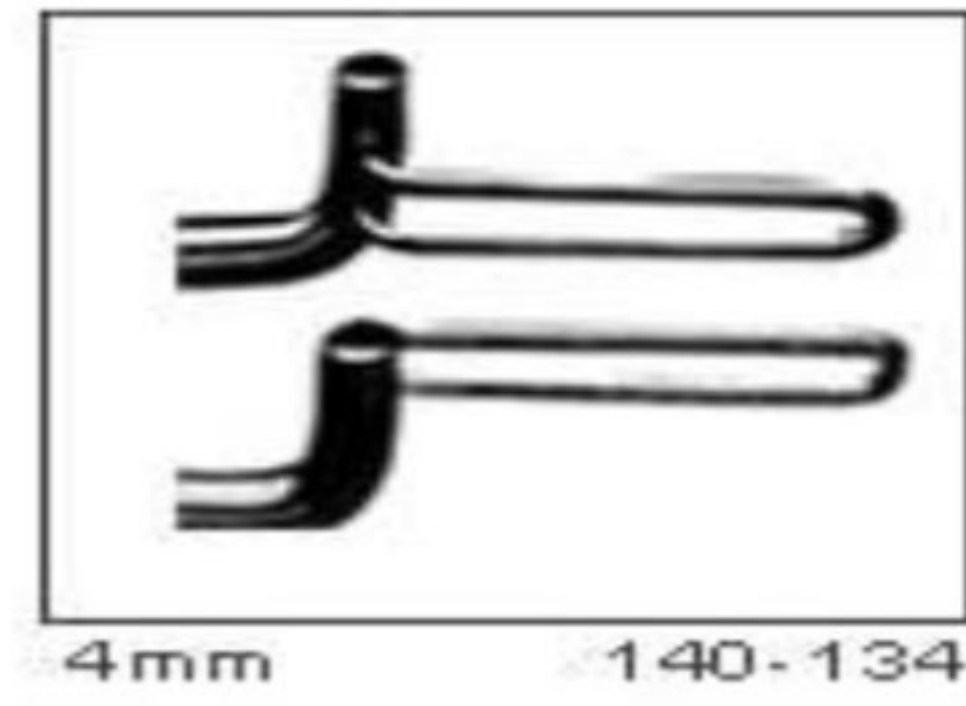

Straight Shafts with 4 mm tip

LC - 140-134 : Insulated

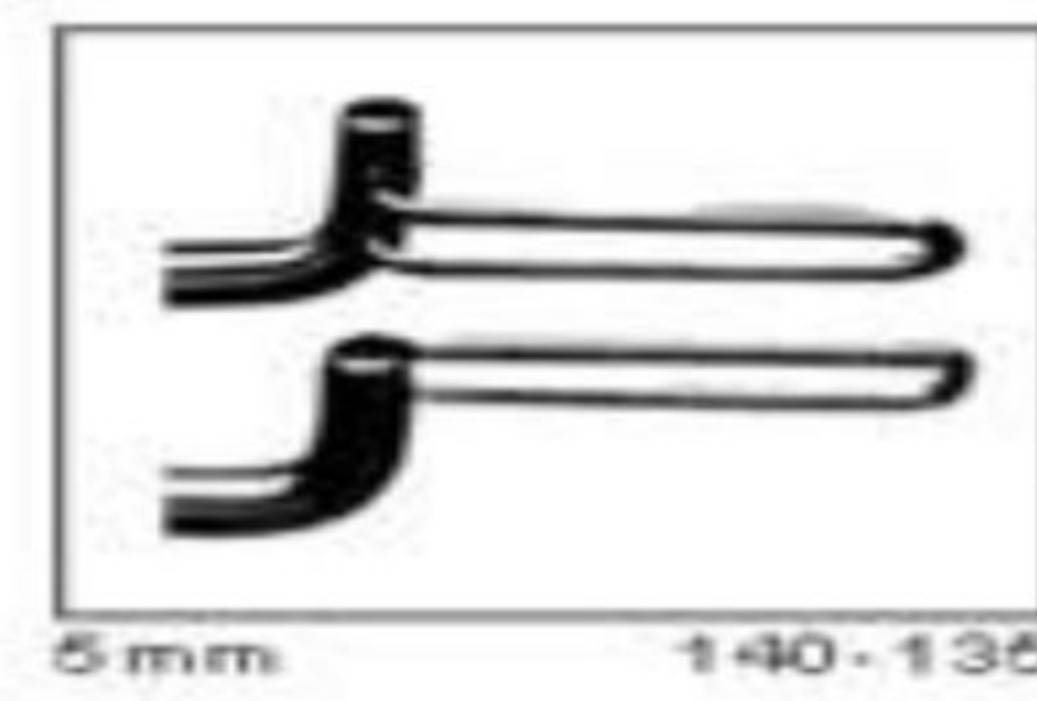

Straight Shafts with 5 mm tip

LC - 140-135 : Insulated

Gelpi Retractor



LC - 140-140 : Insulated

Rigby Retractor



LC - 140-150 : Insulated

Schroeder Tanaculum



LC - 140-160 : Insulated

Emmet Hook



LC - 140-170 : Insulated

Lris Hook



LC - 140-175 : Insulated

Straight Hook



Angled Shafts with 25 cm long

LC - 140-176 : Insulated

Two - Prong Hook



Curved Shafts with 25 cm long

LC - 140-178 : Insulated

Three - Prong Hook



Curved Shafts with 25 cm long

LC - 140-179 : Insulated

Silicone Bipolar Cable



Shafts with 3.0 m, 5.0m tip

LC - 190-100 10cm
LC - 190-105 16.5 cm

Silicone European Bipolar Cable



Shafts with 3.0 m, 5.0m tip

LC - 190-110 10cm
LC - 190-115 16.5 cm

Silicone European Bipolar Cable (Martin)

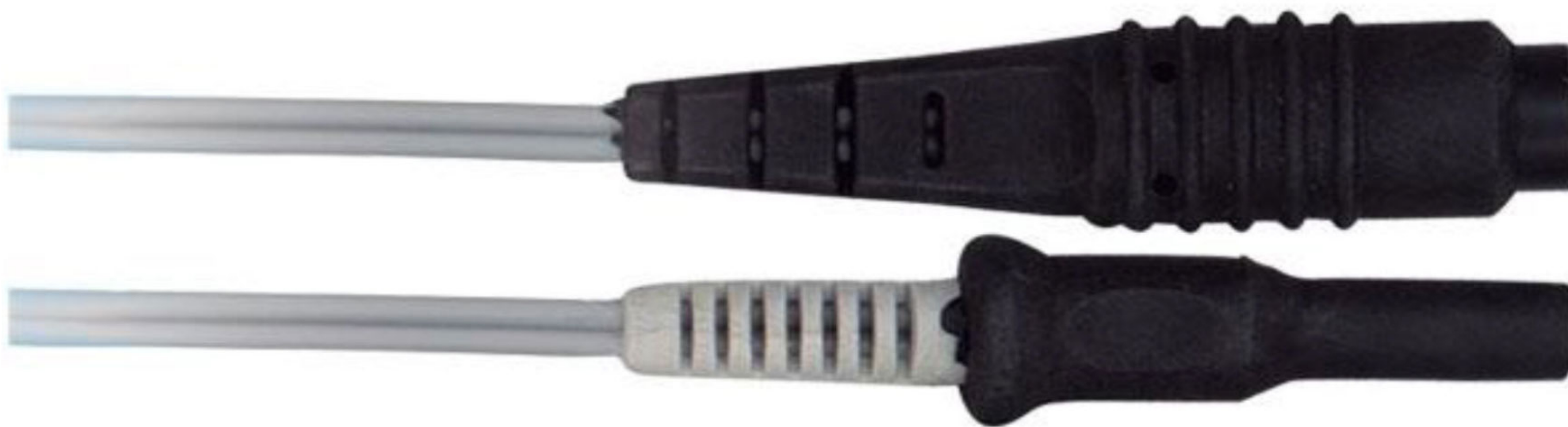

Shafts with 3.0 m, 5.0m tip

LC - 190-120 10cm
LC - 190-125 16.5 cm

Silicone Bipolar Cable



Shafts with 3.0 m, 5.0m tip

LC - 190-130 10cm

LC - 190-135 16.5 cm

Silicone European Bipolar Cable (Erbe)



Shafts with 3.0 m, 5.0m tip

LC - 190-140 10cm

LC - 190-145 16.5 cm

Silicone Bipolar Cable (Erbe)



Shafts with 3.0 m, 5.0m tip

LC - 190-150 10cm

LC - 190-155 16.5 cm

Silicone European Bipolar Cable (Valleylab)

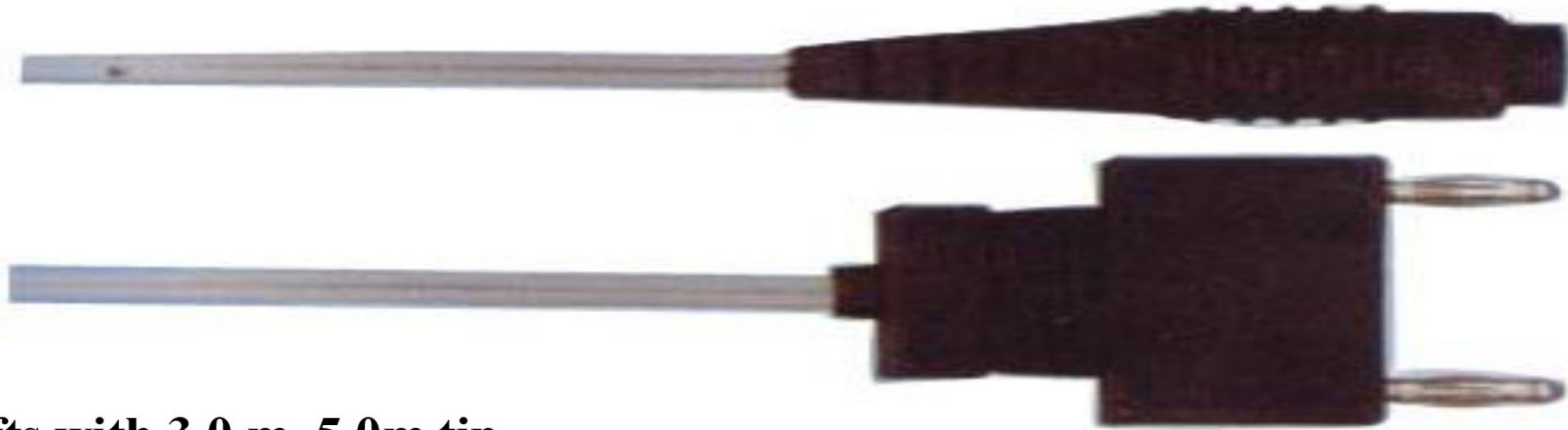

Shafts with 3.0 m, 5.0m tip

LC - 190-160 10cm
LC - 190-165 16.5 cm

Silicone Bipolar Cable (Valleylab)

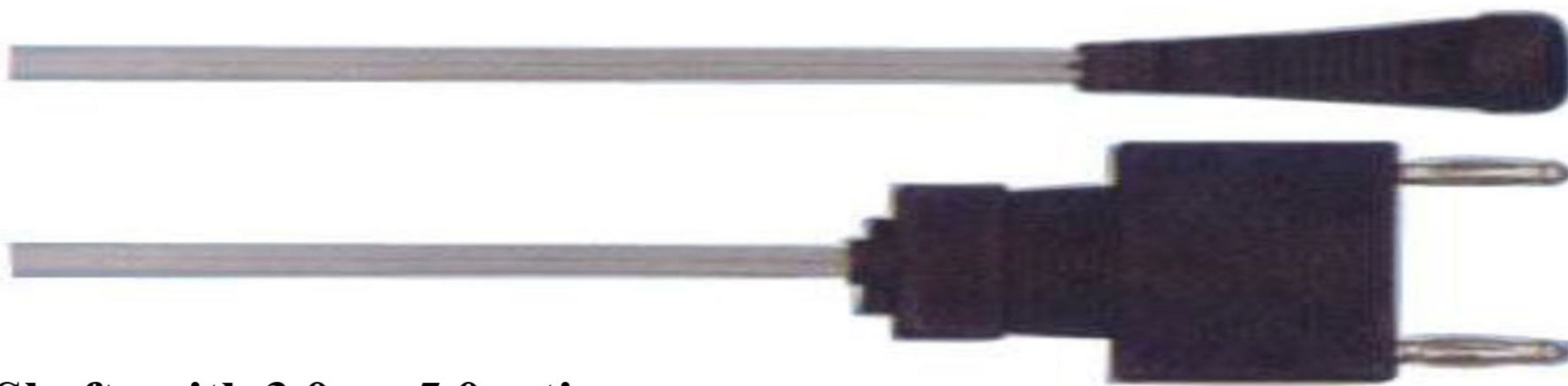

Shafts with 3.0 m, 5.0m tip

LC - 190-170 10cm
LC - 190-175 16.5 cm

Silicone Bipolar Artery Sealer Cables

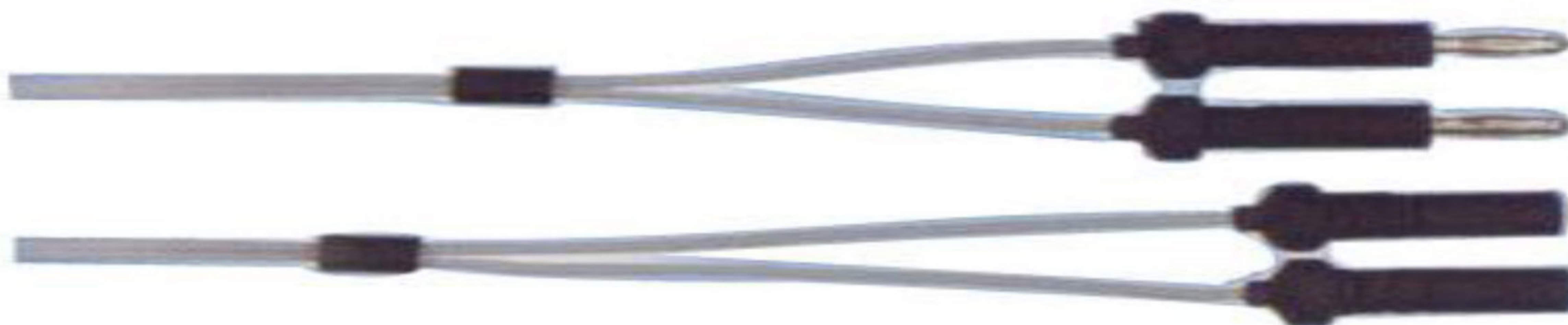

Shafts with 3.0 m tip

LC - 190-180 10cm

Silicone Monopolar Cable



Shafts with 3 m tip, 10cm long

LC - 190-230

(Instrument Connector: Screw Type Pin Plug Generator Connector Standar Bovie 8 mm Type)

Silicone Monopolar Endoscopic Cable



Shafts with 3 m tip, 10cm long

LC - 190-240

(Instrument Connector: 4 mm Female Fitting Generator Connector Standar Bovie 8 mm Plug)



Shafts with 10cm long

LC - 190-250

(Instrument Connector: 4 mm Female Fitting Generator Connector Standar Bovie 4 mm Banana Plug)

Jeweler



Fig. #4 Straight Shafts with 0.5mm tip, 11.5 cm long LC - 110-150 HS: Insulated

Semkin



Straight Shafts with 0.75mm tip, 14.0 cm long LC - 110-220 HS: Insulated

Janson Bayonet



Straight Shafts with 0.75mm tip, 19.1 cm long LC - 110-370 HS: Insulated

Silicone Diathermy Cable



Shafts with 10cm long

LC - 190-260

(Instrument Connector: 4 mm Male(European Diathermy) Generator Connector Standar Bovie 4 mm Banana Plug)



Shafts with 10cm long

LC - 190-270

(Instrument Connector: 4.8 mm Female (English Diathermy) Generator Connector Standar Bovie 4 mm Banana Plug)



Shafts with 10cm long

LC - 190-280

(Instrument Connector: 4.8 mm Female(English Diathermy) Generator Connector Standar Standar 4 mm Banana Plug)

Scoville-Greenwood



Straight Shafts with 1.5mm tip, 19.7 cm long

LC - 110-430 HS: Insulated

Cushing



Straight Shafts with 1.0 mm tip, 15.9 cm long

LC - 110-230 IR : Insulated

Gerald Bayonet



Straight Shafts with 1.0 mm tip, 18.4 cm long

LC - 110-320 IR : Insulated

Jansen Bayonet



Straight Shafts with 1.5 mm tip, 19.1 cm long

LC - 110-370 IR : Insulated

Scoville-Greenwood



Straight Shafts with 1.5 mm tip, 19.7 cm long LC - 110-430 IR : Insulated

Hardy Bayonet



Straight Shafts with 1.5 mm tip, 21.6 cm long LC - 110-460 IR : Insulated

Potts-Smith



Curved Shafts with 2.0 mm tip, 18.0 cm long

LC - 110-530 HS : Insulated



Curved Shafts with 2.0 mm tip, 21.0 cm long

LC - 110-540 HS : Insulated



Curved Shafts with 2.0 mm tip, 24.0 cm long

LC - 110-550 HS : Insulated

Jansen Bayonet

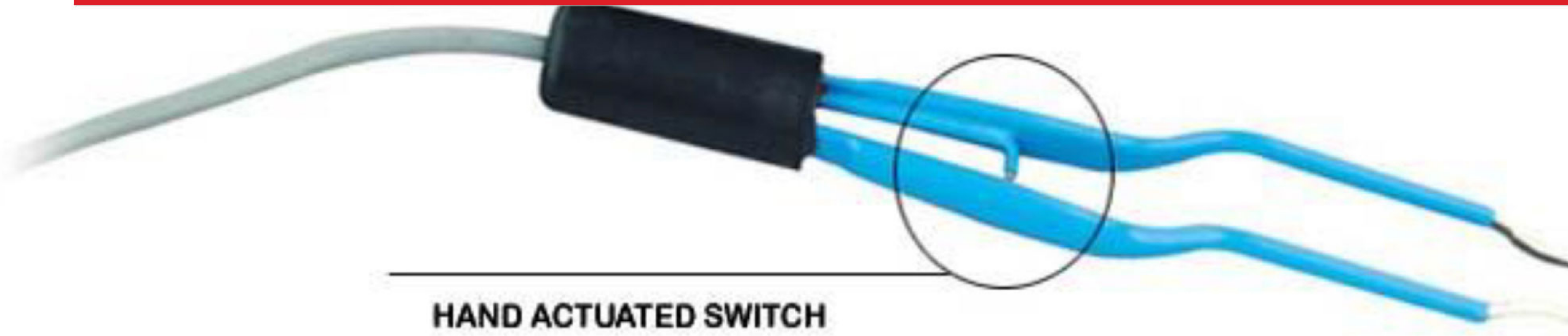

Curved Shafts with 2.0 mm tip, 14.0 cm long

LC - 110-560 HS : Insulated



Curved Shafts with 2.0 mm tip, 19.0 cm long

LC - 110-580 HS : Insulated



Curved Shafts with 2.0 mm tip, 21.0 cm long

LC - 110-590 HS : Insulated

Mc Pherson



Straight Shafts with 0.5 mm tip, 10.2 cm long

LC - 310-100 : Insulated



Angled Shafts with 0.5 mm tip, 10.2 cm long

LC - 310-102 : Insulated

Jeweler



Fig. #5 Straight Shafts with micro, 0.7 mm tip, 11.5 cm long

LC - 310-110 : Insulated

Jeweler



Fig. #5 Angled Shafts with micro, 0.7 mm tip, 11.5cm long

LC - 310-112 : Insulated



Fig. #7 Angled Shafts with micro, 0.7 mm tip, 11.5cm long

LC - 310-115 : Insulated

Adson



Straight Shafts with 1.0 mm tip, 12.1cm long

LC - 310-300 : Insulated

Jeweler



Fig. # 4 straight Shafts with micro 0.5 mm tip,11.5 cm long

LC - 110-150 : Insulated
LC - 120-150 : Non-insulated



Fig. # 5 straight Shafts with micro 0.5 mm tip,11.5 cm long

LC - 110-140 : Insulated
LC - 120-140 : Non-insulated



Fig. # 7 Curved Shafts with micro 0.5 mm tip,11.5 cm long

LC - 110-170 : Insulated
LC - 120-170 : Non-insulated

Adson



Straight Shafts with 1.0 mm tip, 15.0cm long

LC - 310-310 : Insulated

Forceps With Straight Shafts



0.5, 1.0, 2.0mm tip, 15.0cm long

LC - 310-120 : Insulated



0.5, 1.0, 2.0mm tip, 18.0cm long

LC - 310-130 : Insulated

Forceps with straight shafts



0.5, 1.0, 2.0mm tip, 20.0cm long

LC - 310-140 : Insulated



0.5, 1.0, 2.0mm tip, 22.0cm long

LC - 310-150 : Insulated



0.5, 1.0, 2.0mm tip, 24.0cm long

LC - 310-260 : Insulated

Forceps with angled shafts



0.5, 1.0, 2.0mm tip, 15.0cm long

LC - 310-122: Insulated



0.5, 1.0, 2.0mm tip, 18.0cm long

LC - 310-132: Insulated



0.5, 1.0, 2.0mm tip, 20.0cm long

LC - 310-142: Insulated

Forceps with angled shafts



0.5, 1.0, 2.0mm tip, 22.0cm long

LC - 310-152: Insulated



0.5, 1.0, 2.0mm tip, 24.0cm long

LC - 310-262: Insulated

Bayonet Forceps



Straight Shafts with 0.5, 1.0, 2.0mm tip, 16.5cm long

LC - 310-160: Insulated

Bayonet Forceps



Straight Shafts with 0.5, 1.0, 2.0mm tip, 18.0cm long **LC - 310-170: Insulated**



Straight Shafts with 0.5, 1.0, 2.0mm tip, 20.0cm long **LC - 310-180: Insulated**

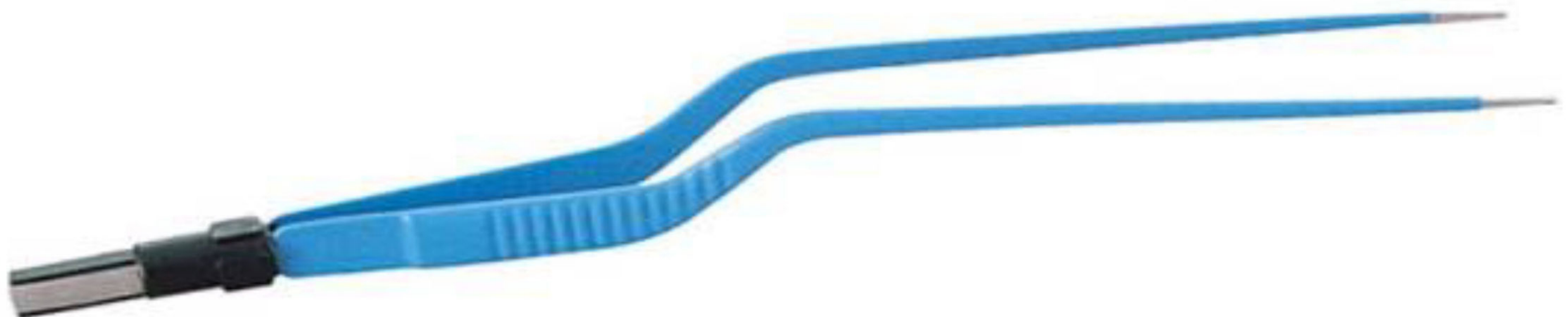

Straight Shafts with 0.5, 1.0, 2.0mm tip, 22.0cm long **LC - 310-190: Insulated**



Straight Shafts with 0.5, 1.0, 2.0mm tip, 24.0cm long

LC - 310-200: Insulated

Angled Bayonet Forceps



Angled up Shafts with 0.5, 1.0, 2.0 mm tip, 16.5cm long

LC - 310-162: Insulated



Angled up Shafts with 0.5, 1.0, 2.0 mm tip, 18.0cm long

LC - 310-172: Insulated



Angled up Shafts with 0.5, 1.0, 2.0 mm tip, 20.0cm long

LC - 310-182: Insulated



Angled up Shafts with 0.5, 1.0, 2.0 mm tip, 22.0cm long

LC - 310-192: Insulated

Angled Bayonet Forceps



Angled up Shafts with 0.5, 1.0, 2.0 mm tip, 24.0cm long

LC - 310-202: Insulated



Angled down Shafts with 0.5, 1.0, 2.0 mm tip, 16.5cm long

LC - 310-165: Insulated



Angled down Shafts with 0.5, 1.0, 2.0 mm tip, 18.0cm long

LC - 310-175: Insulated

Angled Bayonet Forceps



Angled down Shafts with 0.5, 1.0, 2.0 mm tip, 20.0cm long

LC - 310-185: Insulated



Angled down Shafts with 0.5, 1.0, 2.0 mm tip, 22.0cm long

LC - 310-195: Insulated



Angled down Shafts with 0.5, 1.0, 2.0 mm tip, 24.0cm long

LC - 310-205: Insulated

Straight (Insulated)



LC - 310-120IR 15 cm
LC - 310-130IR 18cm
LC - 310-140IR 20 cm



LC - 310-150IR 22cm
LC - 310-200IR 24cm

Bayonet (Insulated)



LC - 310-160IR 16.5 cm
LC - 310-170IR 18cm



LC - 310-180IR 20 cm
LC - 310-190IR 22cm
LC - 310-200IR 24 cm

Tenzel



Curved Shafts with micro 0.5 mm tip, 10.2 cm long

LC - 110-160 : Insulated
LC - 120-160 : Non-insulated

Iris



Straight Shafts with 1.0 mm tip, 10.8 cm long

LC - 110-180 : Insulated
LC - 120-180 : Non-insulated



Curved Shafts with 1.0 mm tip, 10.8 cm long

LC - 110-190 : Insulated
LC - 120-190 : Non-insulated

Adson (Insulated)



Straight Shafts with 0.7mm, 1.0mm, 1.5mm, 2.0mmtip, 12.1 cm long LC - 110-200 NS

Semkin (Insulated)



Straight Shafts with 0.7mm, 1.0mm, 1.5mm, 2.0mmtip, 15.9 cm long LC - 110-230 NS

Gerald Bayonet (Insulated)



Straight Shafts with 0.7mm, 1.0mm, 1.5mm, 2.0mmtip, 18.4 cm long LC - 110-320 NS

Scoville-Greenwood (Insulated)



Straight Shafts with 0.7mm, 1.0mm, 1.5mm, 2.0mmtip, 19.1 cm long LC - 110-430 NS

Yasargil (Insulated)



Straight Shafts with 0.7mm, 1.0mm, 1.5mm, 2.0mmtip, 19.7 cm long LC - 110-440 NS

Straight (Insulated)



15.0 cm long with tip 0.5 mm, 1.0mm, 2.0mm .

LC - 310-120 NS



20.0 cm long with tip 0.5 mm, 1.0mm, 2.0mm .

LC - 310-140 NS



Angled Shafts with 0.5 mm, 1.0mm, 2.0mm tip, 20.0 cm long

LC - 310-142 NS

Bayonet (Insulated)



16.5 cm long with tip 0.5 mm, 1.0mm, 2.0mm .

LC - 310-160 NS



20.0 cm long with tip 0.5 mm, 1.0mm, 2.0mm .

LC - 310-180 NS



Large	LC - 110-750	: Insulated
Small	LC -110-755	: Insulated

Silicone Bipolar Artery Sealer Cables



LC - 190-180 : Insulated

Straight



LC - 310-500	18.0 cm
LC - 310-510	20cm
LC - 310-520	22 cm
LC - 310-530	27 cm

Angled



LC - 310-540	18.0 cm
LC - 310-550	20cm
LC - 310-560	22 cm



LC - 310-570	16.5 cm
LC - 310-580	20cm

Angled (Upward Tip)



LC - 310-590 19 cm

Angled 45

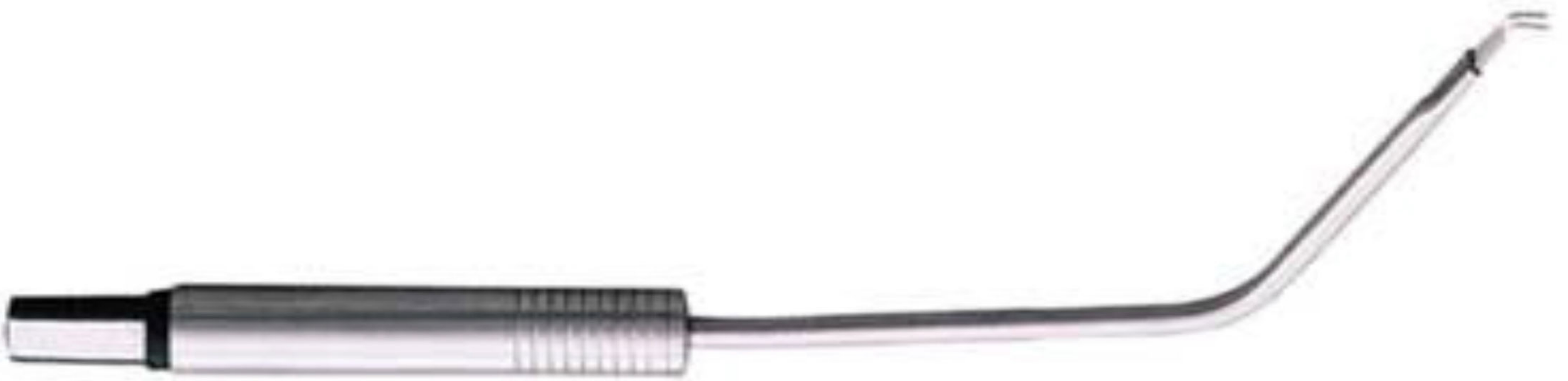

LC - 310-600 16 cm

Angled 90

Jeweler #5 (Insulated)



LC - 210-140 11.5 cm



LC - 410-110 11.5 cm

Straight (Insulated)

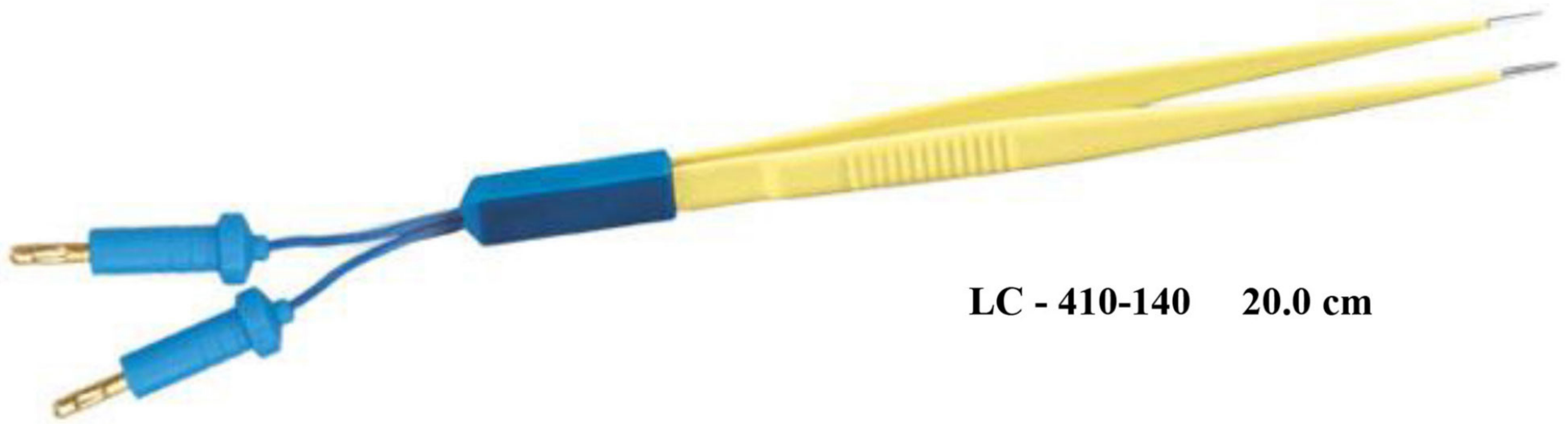

LC - 410-140 20.0 cm

Bayonet (Insulated)



LC - 410-180 20.0 cm

Adson (Insulated)



LC - 210-200 12.1 cm

Gerald (Insulated)



LC - 210-300 17.8 cm

Jansen Bayonet (Insulated)



LC - 210-370 20.4 cm

Irrigation Shafts



LC - 210-360 IR 17.8 cm

Adson



Straight Shafts with 2.0 mm tip, 12.0 cm long

LC - 320-100 : Insulated

McIndoe



Straight Shafts with 2.0 mm tip, 15.0 cm long

LC - 320-110 : Insulated

Gillies (1x2) (Insulated)



- LC - 320-120 15 .0cm**
- LC - 320-122 17.8cm**
- LC - 320-124 20.0 cm**
- LC - 320-126 24.0 cm**

Adson



Straight Shafts with 1.0 mm tip, 12.1 cm long

LC - 110-200 : Insulated

LC - 120-200 : Non-insulated

Semkin



Straight Shafts with 0.5 mm tip, 14.0 cm long

LC - 110-220 : Insulated

LC - 120-220 : Non-insulated

Semkin



Straight Shafts with 1.0, 1.5 mm tip, 15.9 cm long

LC - 110-230 : Insulated

LC - 120-230 : Non-insulated



Straight Shafts with 1.0, 2.0 mm tip, 17.8 cm long

LC - 110-235 : Insulated

LC - 120-235 : Non-insulated

Dissecting Forceps (Insulated)



Straight Shafts with 2.0 mm tip.

LC - 320-130	15 .0cm
LC - 320-132	17.8cm
LC - 320-134	21.0 cm
LC - 320-136	24.1 cm

Gerald (1×2)



Straight Shafts with 2.0 mm tip, 17.8 cm long

LC - 320-140 : Insulated

Adson Bayonet (Insulated)



Straight Shafts with 2.0 mm tip.

LC - 320-150	16 .0cm
LC - 320-152	19.1cm
LC - 320-154	21.0 cm

Adson Bayonet (Insulated)



Angled up Shafts with 2.0 mm tip.

- LC - 320-160 16.0cm
- LC - 320-162 19.1cm
- LC - 320-164 21.0 cm

Remington Hob



Shafts with 2.0 mm tip, 24.1 cm long

LC - 320-170 : Insulated

Turner-Warwick Scissors (Insulated)



Straight Shafts

- LC - 320-200 17.8 cm
- LC - 320-210 23.0 cm

Turner-Warwick Scissors (Insulated)



Curved Shafts

LC - 320-202 17.8 cm
LC - 320-212 23.0 cm

Surgical Scissors(Insulated)



Straight Shafts

LC – 320-220 17.8 cm
LC – 320-230 23.0 cm



Curved Shafts

LC – 320-222 17.8 cm
LC – 320-232 23.0 cm

Wilson Hey Forceps (Insulated)



Straight Shafts

LC – 320-240	17.8 cm
LC – 320-250	23.0 cm



Curved Shafts

LC – 320-242	17.8 cm
LC – 320-252	23.0 cm

Artery Forceps (Insulated)

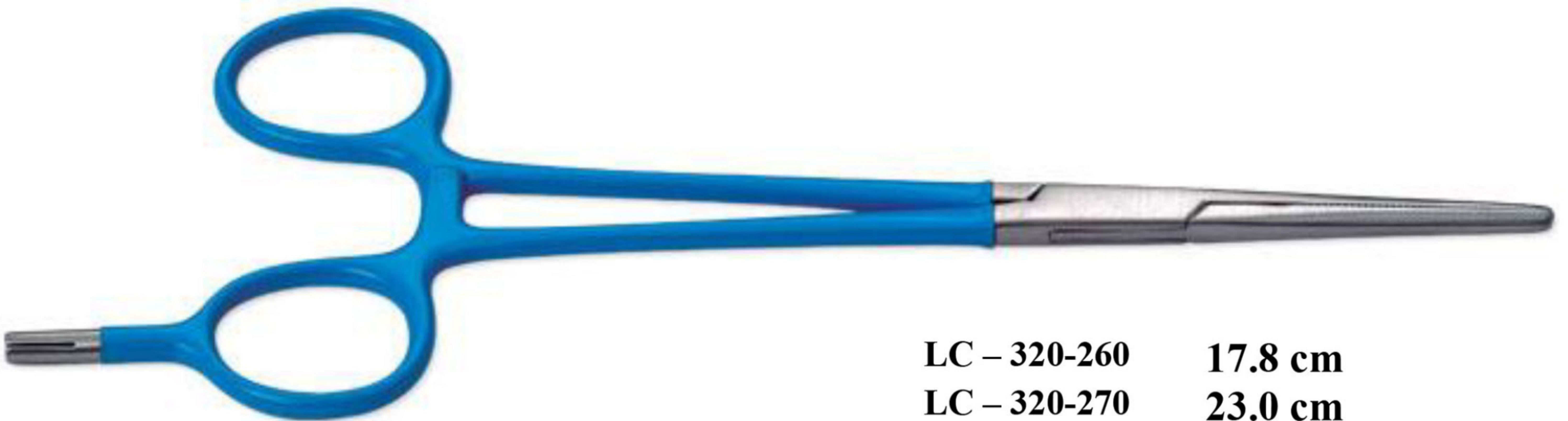

Straight Shafts

LC – 320-260	17.8 cm
LC – 320-270	23.0 cm

Artery Forceps(Insulated)



Curved Shafts

LC – 320-262	17.8 cm
LC – 320-272	23.0 cm

Richie Forceps (Insulated)



LC – 320-290	17.8 cm
LC – 320-292	20.0 cm
LC – 320-296	23.0 cm

Adson



Straight Shafts with 1.0 mm tip, 12 cm long

LC - 330-100 : Insulated

McIndoe



Straight Shafts with 2.0 mm tip, 21cm long

LC - 330-110 : Insulated

Gillies(1x2)(Insulated)



- LC – 330-120 15 cm**
- LC - 330-122 17cm**
- LC - 330-124 20 cm**
- LC - 330-126 24 cm**

Dissecting Forceps(Insulated)



LC – 330-130	15 cm
LC - 330-132	17.8cm
LC - 330-134	20 cm
LC - 330-136	24 cm

Gerald (1x2)(Insulated)



LC – 330-140	17.8 cm
--------------	---------

Adson Bayonet(Insulated)



LC – 330-150	16 cm
LC - 330-152	19.1cm
LC - 330-154	21.0 cm

Adson Bayonet (Insulated)



Angled Up Shafts

LC – 330-160	16 cm
LC - 330-162	19.1cm
LC - 330-164	21.0 cm

Remington Hob(Insulated)



LC – 330-170	24.1 cm
--------------	---------

Turner-Warwick Scissors (Insulated)



Straight Shafts

LC – 330-200	17.8 cm
LC – 330-210	23.0 cm

Turner-Warwick Scissors (Insulated)



Curved Shafts

LC – 330-202 17.8 cm
LC – 330-212 23.0 cm

Surgical Scissors(Insulated)



Straight Shafts

LC – 330-220 17.8 cm
LC – 330-230 23.0 cm



Curved Shafts

LC – 330-222 17.8 cm
LC – 330-232 23.0 cm

Wilson Hey Forceps (Insulated)

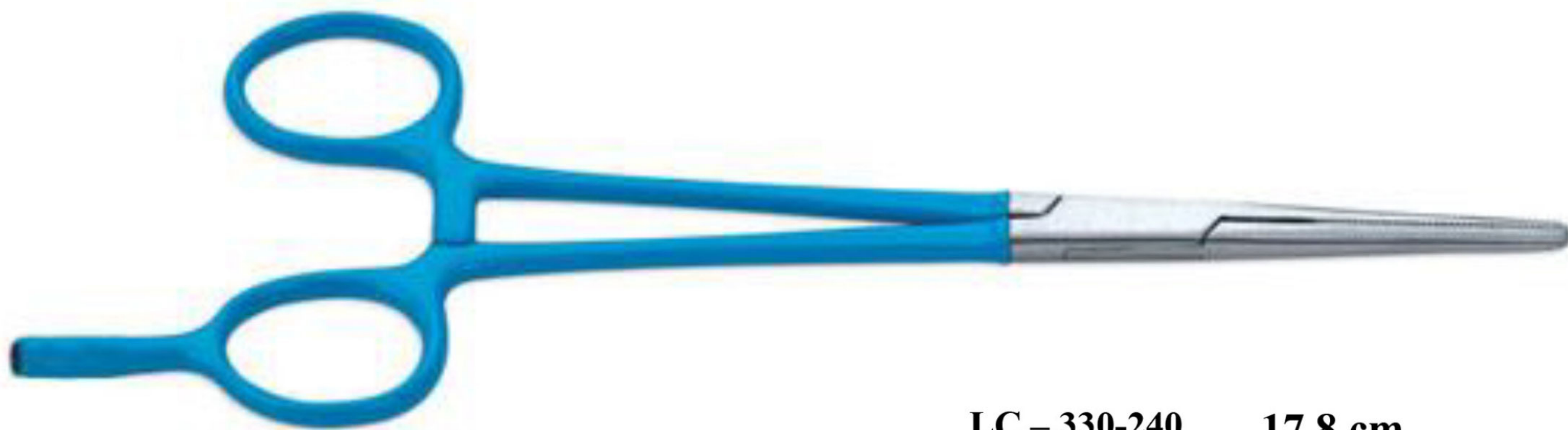

Straight Shafts

LC – 330-240 17.8 cm
 LC – 330-250 23.0 cm



Curved Shafts

LC – 330-242 17.8 cm
 LC – 330-252 23.0 cm

Artery Forceps (Insulated)



Straight Shafts

LC – 330-260 17.8 cm
 LC – 330-270 23.0 cm

Cushing (Gursh)



Straight Shafts with 2.0 mm tip, 17.8 cm long **LC - 110-240 : Insulated**
LC - 120-240 : Non-insulated

Gerald



Straight Shafts with 1.0, 1.5 mm tip, 17.8 cm long **LC - 110-300 : Insulated**
LC - 120-300 : Non-insulated



Angled Shafts with 1.0, 1.5 mm tip, 17.8 cm long **LC - 110-310 : Insulated**
LC - 120-310 : Non-insulated



Bayonet Straight Shafts with 1.0, 1.5 mm tip, 18.4 cm long **LC - 110-320 : Insulated**
LC - 120-320 : Non-insulated

Artery Forceps(Insulated)



Curved Shafts

LC – 330-262	17.8 cm
LC – 330-272	23.0 cm

Richie Forceps (Insulated)



LC – 330-290	17.8 cm
LC – 330-292	20.0 cm
LC – 330-296	23.0 cm

Adson



Straight Shafts with 1.0 mm tip, 12 cm long

LC - 340-100 : Insulated

McIndoe



Straight Shafts with 1.0 mm, 2.0mm tip, 15.0 cm long

LC - 340-110 : Insulated

Gillies (1x2) (Insulated)



- LC - 340-120 15.0 cm**
- LC - 340-122 17.8cm**
- LC - 340-124 20.0 cm**
- LC - 340-126 24 .0cm**

Dissecting Forceps (Insulated)



Straight Shafts with 1.0 mm, 2.0mm tip

LC – 340-130	15.0 cm
LC - 340-132	17.8cm
LC - 340-134	21.0 cm
LC - 340-136	24 .1cm

Gerald (1x2) (Insulated)



LC - 340-140	17.8cm
---------------------	---------------

Adson Bayonet (Insulated)



Straight Shafts with 1.0 mm, 2.0mm tip

LC – 340-150	16 .0cm
LC - 340-152	19.1cm
LC - 340-154	21.0 cm

Adson Bayonet(Insulated)



Angled Up Shafts

LC – 340-160 16.0 cm

LC - 340-162 19.1cm

LC - 340-164 21.0 cm

Remington Hob(Insulated)



LC – 340-170 24.1 cm

Adson



Straight Shafts with 1.0 mm tip, 12.0 cm long

LC - 350-100 : Insulated

McIndoe



Straight Shafts with 1.0, 2.0 mm tip, 15.0cm long

LC - 350-110 : Insulated

Gillies (1x2) Insulated



LC - 350-120	15.0 cm
LC - 350-122	17.8cm
LC - 350-124	20 cm
LC - 350-126	24 cm

Dissecting Forceps Insulated



Straight Shafts with 1.0, 2.0 mm tip

LC – 350-130	15.0 cm
LC - 350-132	17.8cm
LC - 350-134	21.0cm
LC - 350-136	24.1 cm

Gerald (1x2) Insulated



LC – 350-140	17.8 cm
--------------	---------

Adson Bayonet Insulated



LC – 350-150	16.0 cm
LC - 350-152	19.1cm
LC - 350-154	21.0cm

Adson Bayonet Insulated



Angled up Shafts with 1.0, 2.0 mm tip

LC – 350-160	16.0 cm
LC - 350-162	19.1cm
LC - 350-164	21.0cm

Remington Hob



Angled Shafts with 1.0, 2.0 mm tip, 24.1cm long

LC - 350-170 : Insulated

Without Suction



L-Hook Electrode

LC - 150-200 36 Cm



J-Hook Electrode

LC - 150-210 36 Cm



Needle Electrode

LC - 150-220 36 Cm



Spatula Electrode

LC - 150-230 36 Cm



Ball Electrode

LC - 150-240 36 Cm

With Suction



L-Hook Electrode

LC - 150-205 36 Cm



J-Hook Electrode

LC - 150-215 36 Cm



Needle Electrode

LC - 150-225 36 Cm



Spatula Electrode

LC - 150-235 36 Cm



Ball Electrode

LC - 150-245 36 Cm

Dagger



Hook



Jansen Bayonet

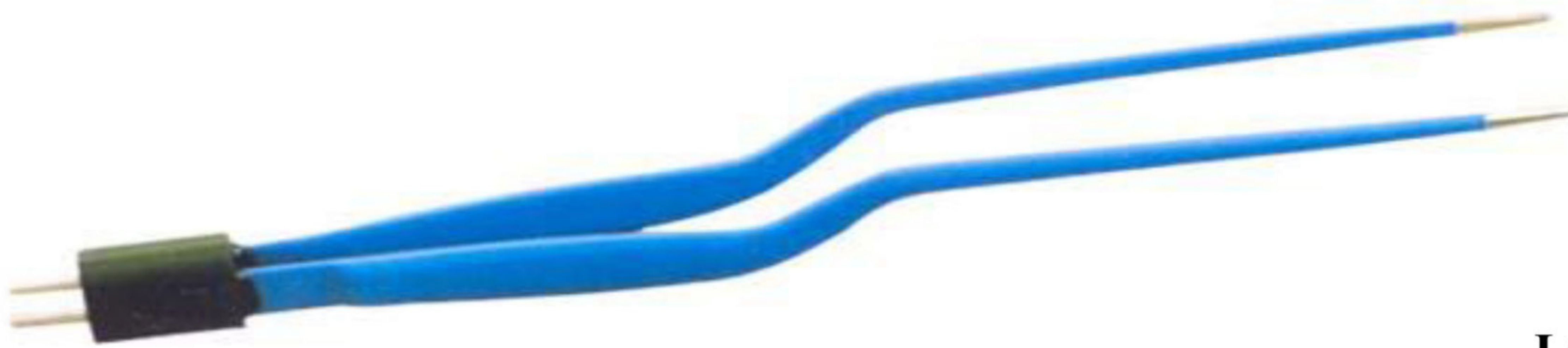

Straight Shafts with 0.5, 1.0, 1.5 mm tip, 15.2 cm long

LC - 110-350 : Insulated
LC - 120-350 : Non-insulated



Straight Shafts with 0.5, 1.0, 1.5 mm tip, 17.8 cm long

LC - 110-360 : Insulated
LC - 120-360 : Non-insulated



Straight Shafts with 1.0, 1.5, 2.0 mm tip, 20.4 cm long

LC - 110-370 : Insulated
LC - 120-370 : Non-insulated

Malis



Straight Shafts with 0.5, 1.0, 2.0 mm tip, 17.8 cm long

LC - 110-400 : Insulated
LC - 120-400 : Non-insulated

Hockey



LC - 150-280 12 Cm



LC - 150-282 18Cm

Frazier Suction Tube



LC - 150-300 13.5 Cm



LC - 150-310 20.5 Cm



LC - 150-320 40.6 Cm

Finger-switch Pencil (Single Use)



LC - 150-100 3 m Cable



LC - 150-101 5 m Cable

Foot Control Pencil (Single Use)



LC - 150-102 3 m Cable

Foot Control Pencil (Single Use)



LC - 150-103 5 m Cable

Rocker-switch Pencil (Single Use)



LC - 150-104 3 m Cable

Finger-switch Pencil (Reusable)



LC - 150-105

Electrode Handle (Reusable)



LC - 150-107

Patient Return Cable



LC - 150-600 5 m Cable
LC - 150-602 3 m Cable

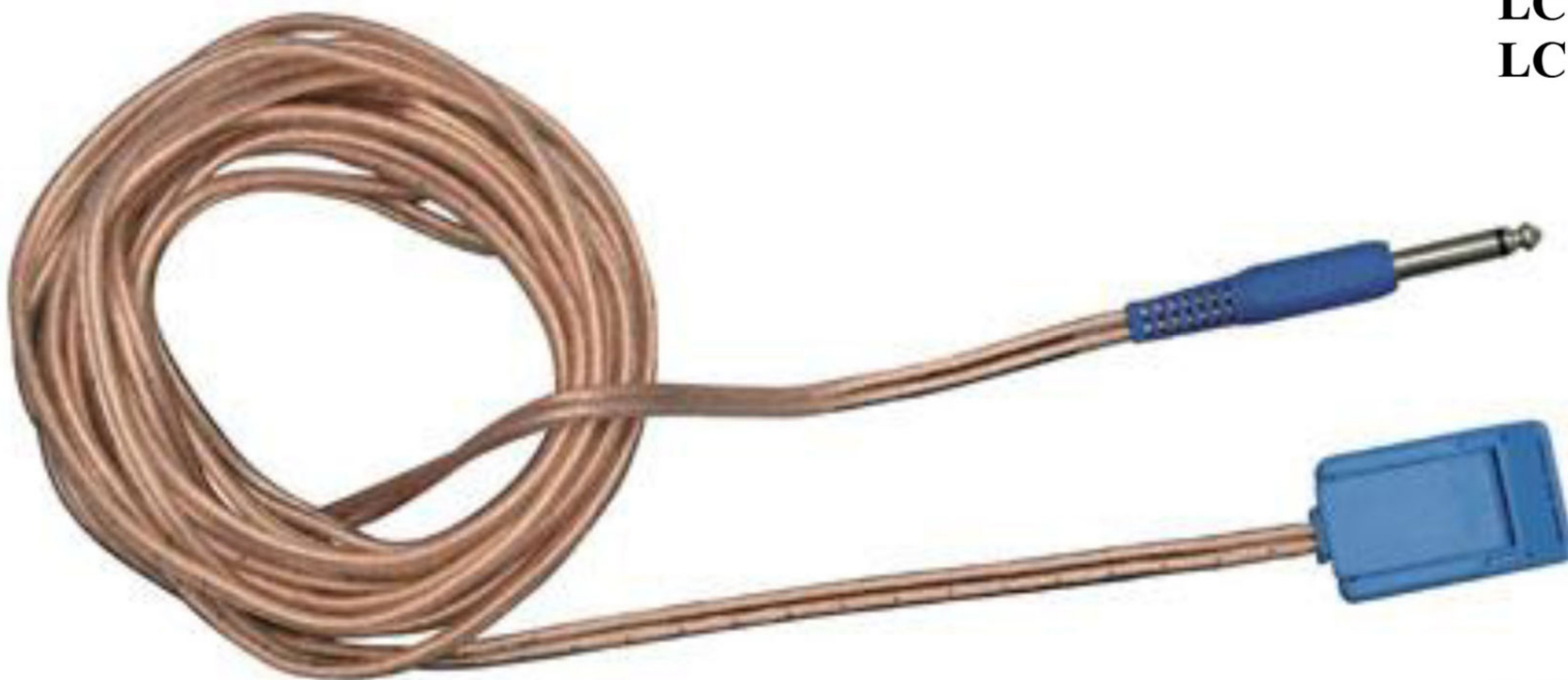

LC - 150-610 5 m Cable
LC - 150-612 3 m Cable

Scoville-Greenwood



Straight Shafts with 1.0, 2.0 mm tip, 19.1 cm long

LC - 110-430 : Insulated

LC - 120-430 : Non-insulated

Yasargil



Straight Shafts with 1.0, 1.5 mm tip, 19.7 cm long

LC - 110-440 : Insulated

LC - 120-440 : Non-insulated

Hardy Bayonet



Straight Shafts with 1.0 mm tip, 21.6 cm long

LC - 110-460 : Insulated

LC - 120-460 : Non-insulated



Angled Shafts with 1.0 mm tip, 21.6 cm long

LC - 110-470 : Insulated

LC - 120-470 : Non-insulated

Jeweler



Fig. #4 Straight Shafts with micro tip, 11.5 cm long

LC - 110-500 : Insulated



Fig. #7 Curved Shafts with micro tip, 11.5 cm long

LC - 110-510 : Insulated

Adson



Straight Shafts with 1.0 mm tip, 12.1 cm long

LC - 110-520 : Insulated

Potts-smith



Straight Shafts with 2.0 mm tip, 17.8 cm long

LC - 110-530 : Insulated



Straight Shafts with 2.0 mm tip, 21.0 cm long

LC - 110-540 : Insulated



Straight Shafts with 2.0 mm tip, 24.1 cm long

LC - 110-550 : Insulated