

- EN** Neurosurgery
- DE** Neurochirurgie
- ES** Neuro Cirugía

Page 373 to 387

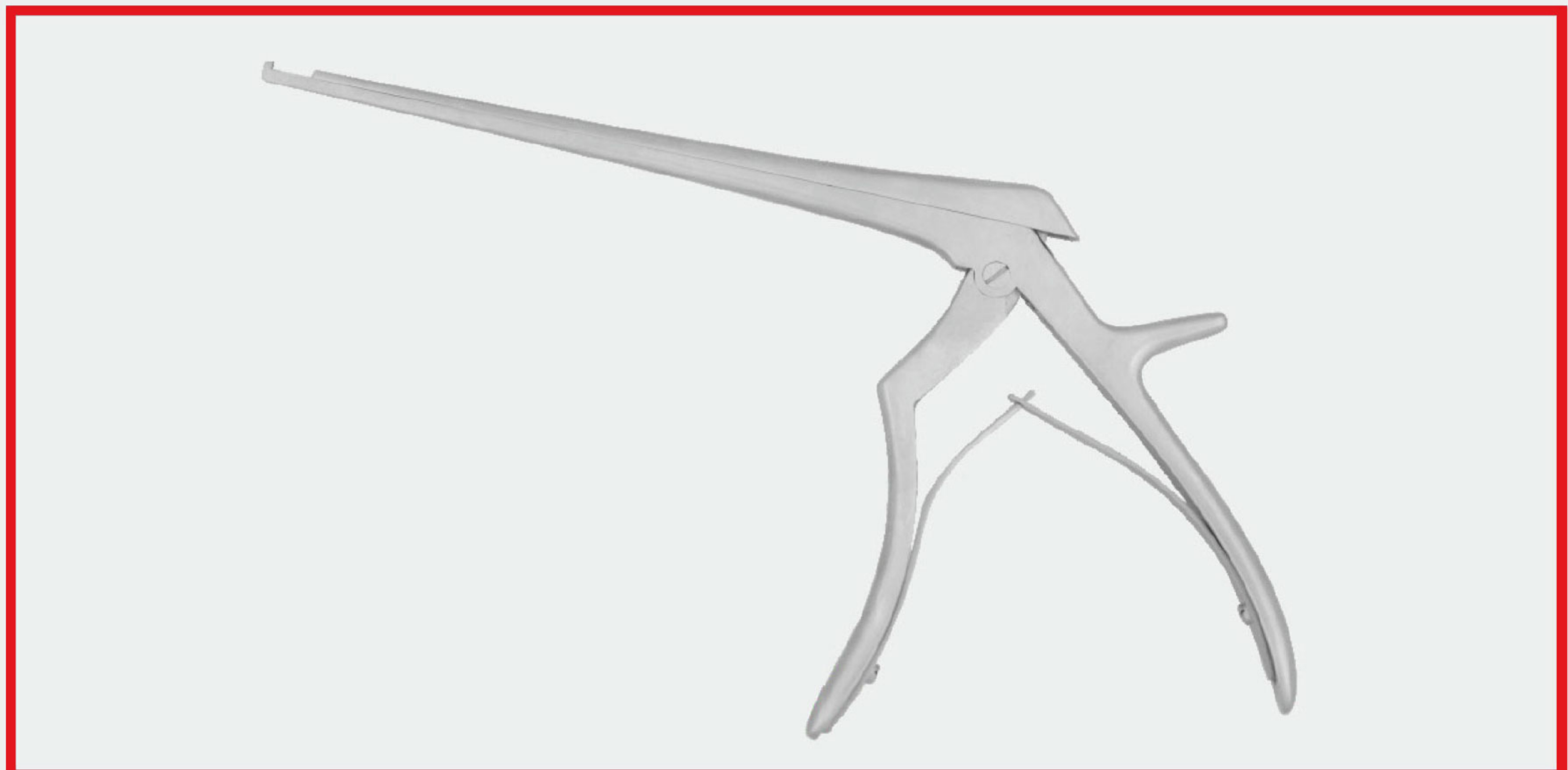

- EN** —● Dura Hooks, Nerve Hooks, Dura Dissectors
- DE** —● Durahaken, Nervhaken, Dura-Dissektoren
- ES** —● Ganchos para dura-madre, Ganchos para nervios, Disecadores de dura-madre



FRAZIER
OI 18-5301-15
15 cm/5 7/8"



HOEN
OI 18-5302-15
15 cm/5 7/8"



HOEN
OI 18-5303-15
15 cm/5 7/8"



SACHS
OI 18-5304-21
21 cm/8 1/4"

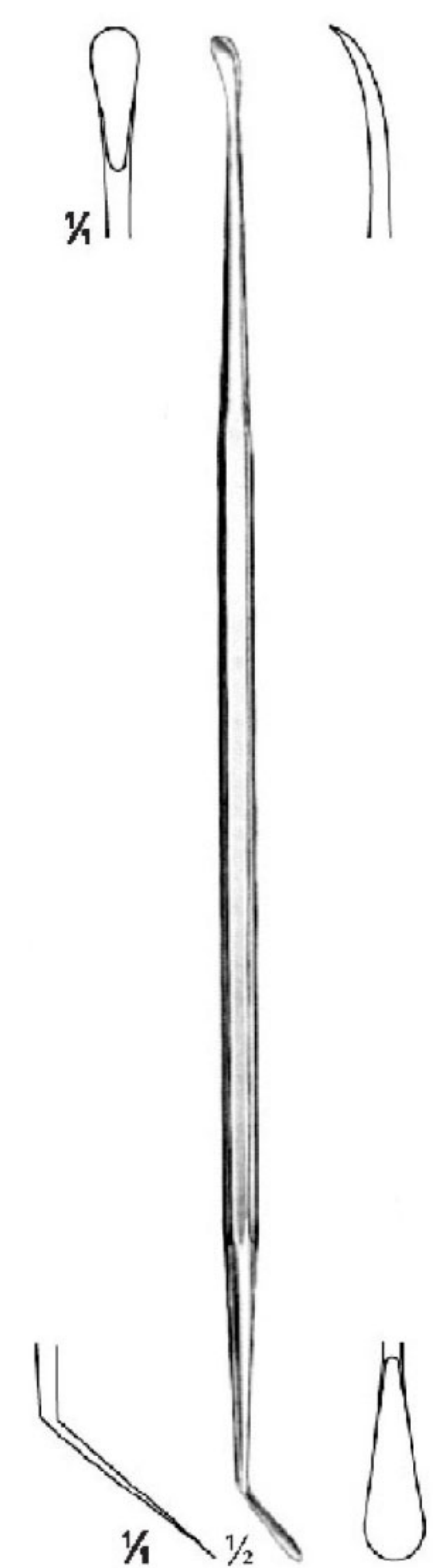

MILLIGAN
OI 18-5305-21
21 cm/8 1/4"

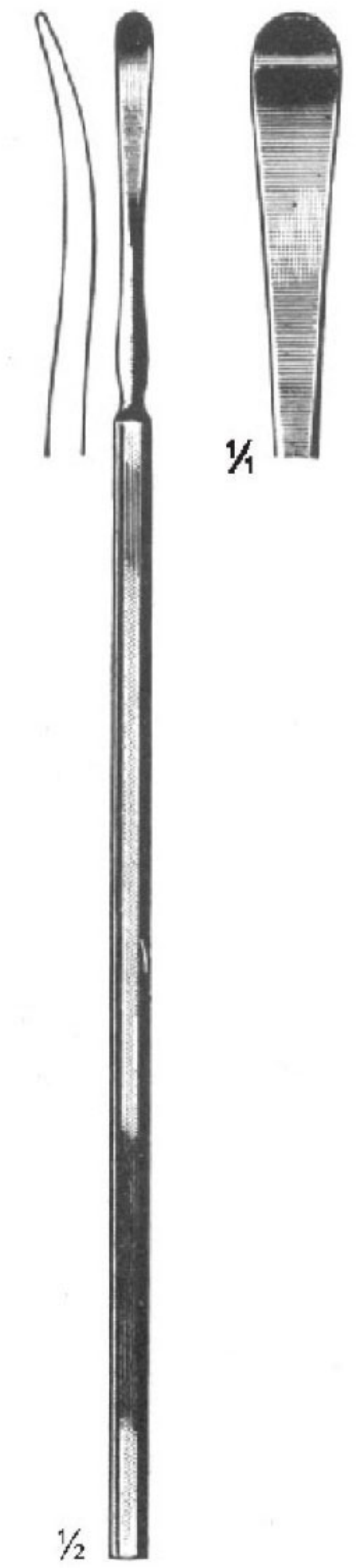

SACHS
OI 18-5306-21
21 cm/8 1/4"

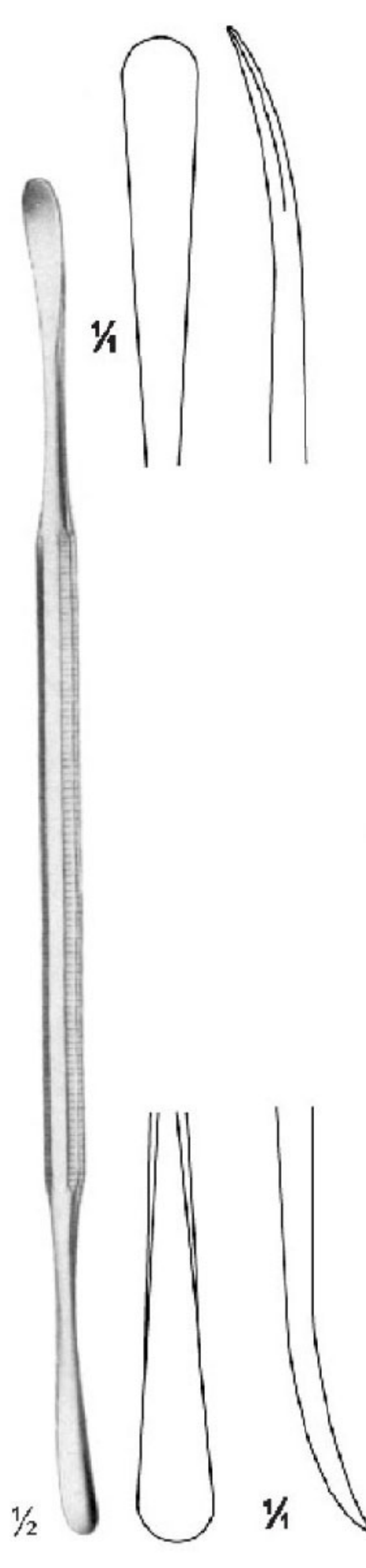

OI 18-5307-22
22 cm/8 3/4"

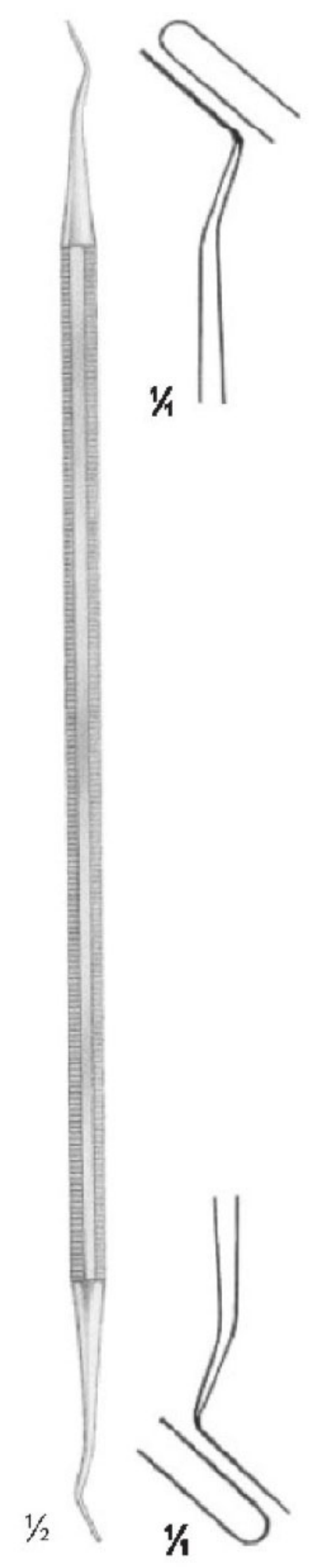

WOODSON
OI 18-5308-25
25 cm/9 7/8"

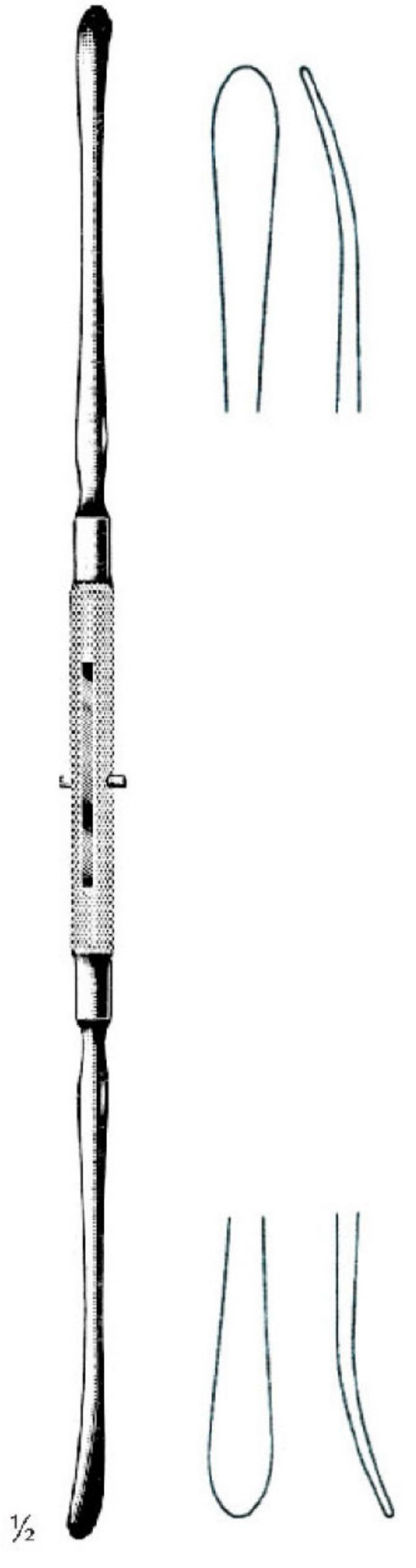

DAVIS
OI 18-5309-24
24.5 cm/9 3/4"

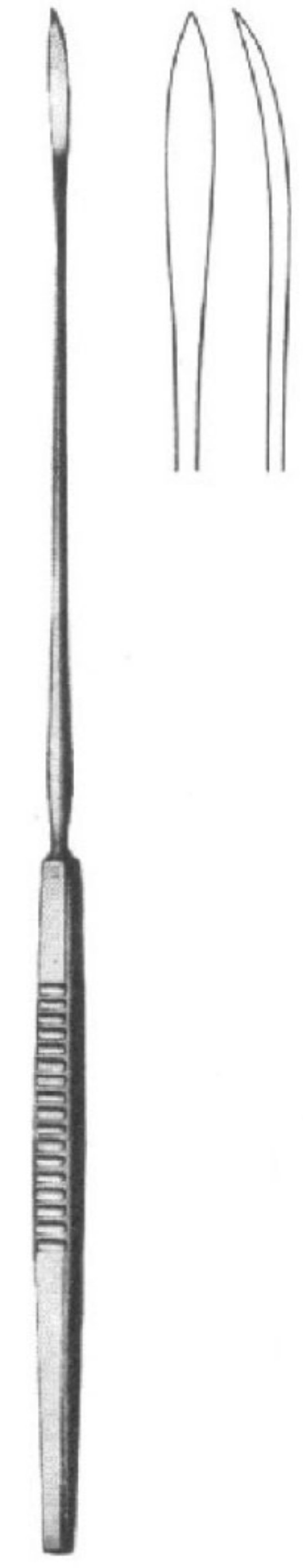

OI 18-5310-21
21 cm/8 1/4"



FAGER
OI 18-5311-20
20 cm/7 7/8"



FAGER
OI 18-5312-20
20 cm/7 7/8"

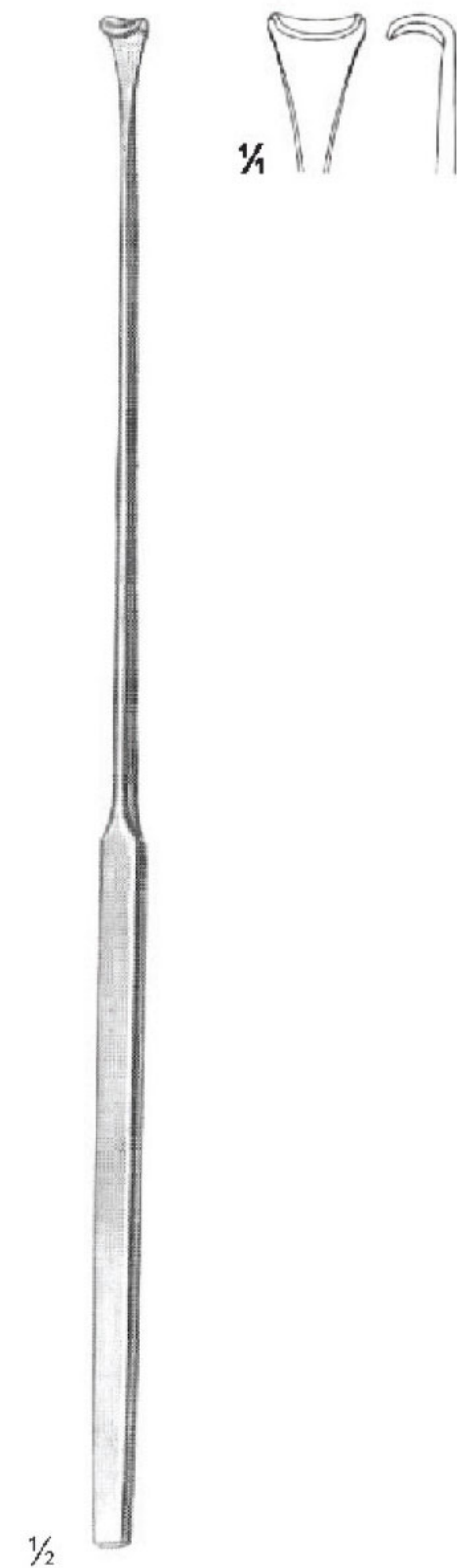

LOVE
 OI 18-5313-21
 21.5 cm/8 1/2"

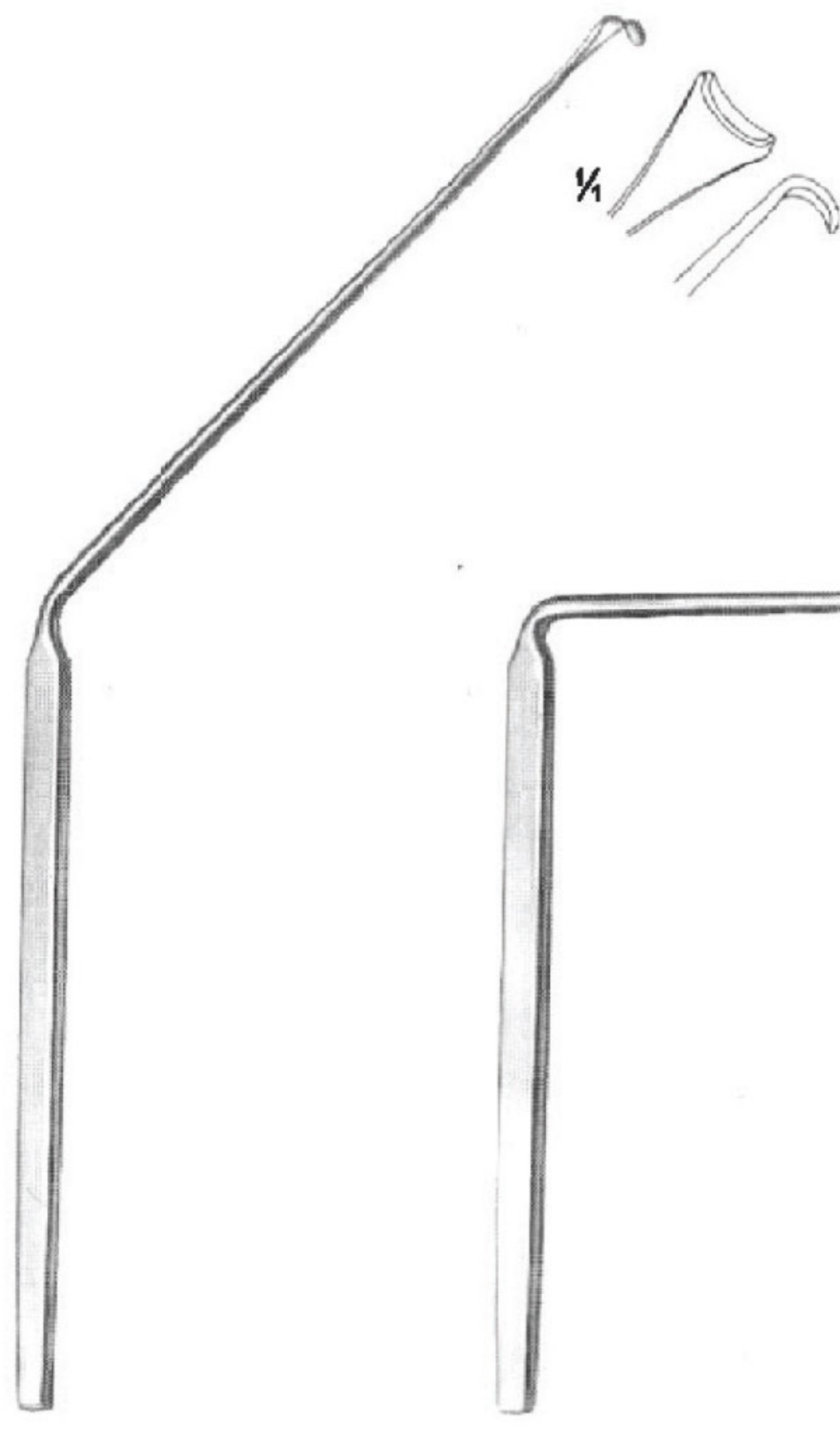

LOVE
 OI 18-5314-17
 17.5 cm/6 7/8"

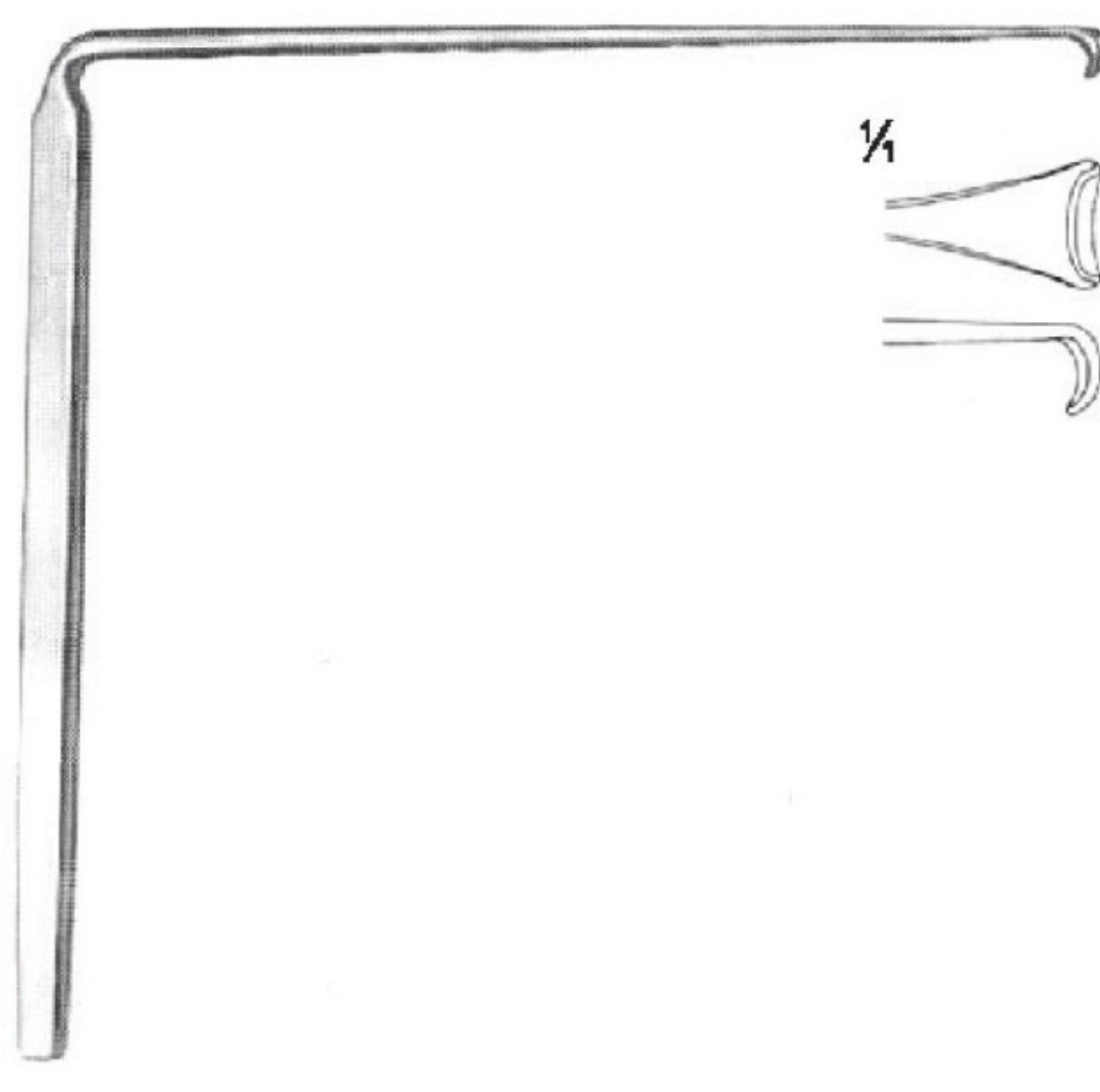

LOVE
 OI 18-5315-11
 11 cm/4 3/8"

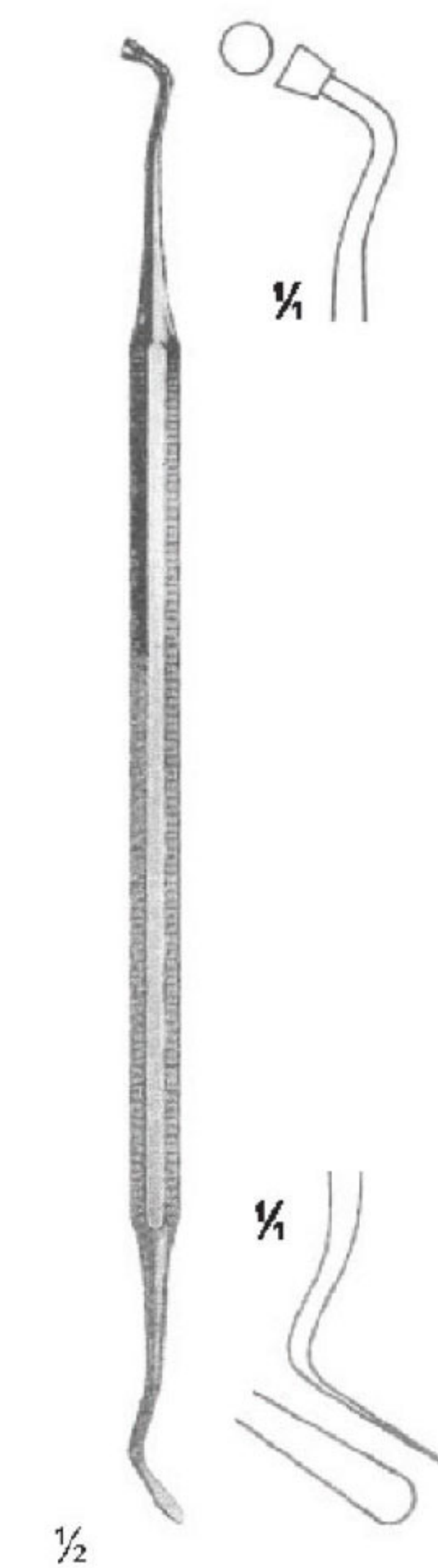

WOODSON
 OI 18-5316-17
 17 cm/6 3/4"

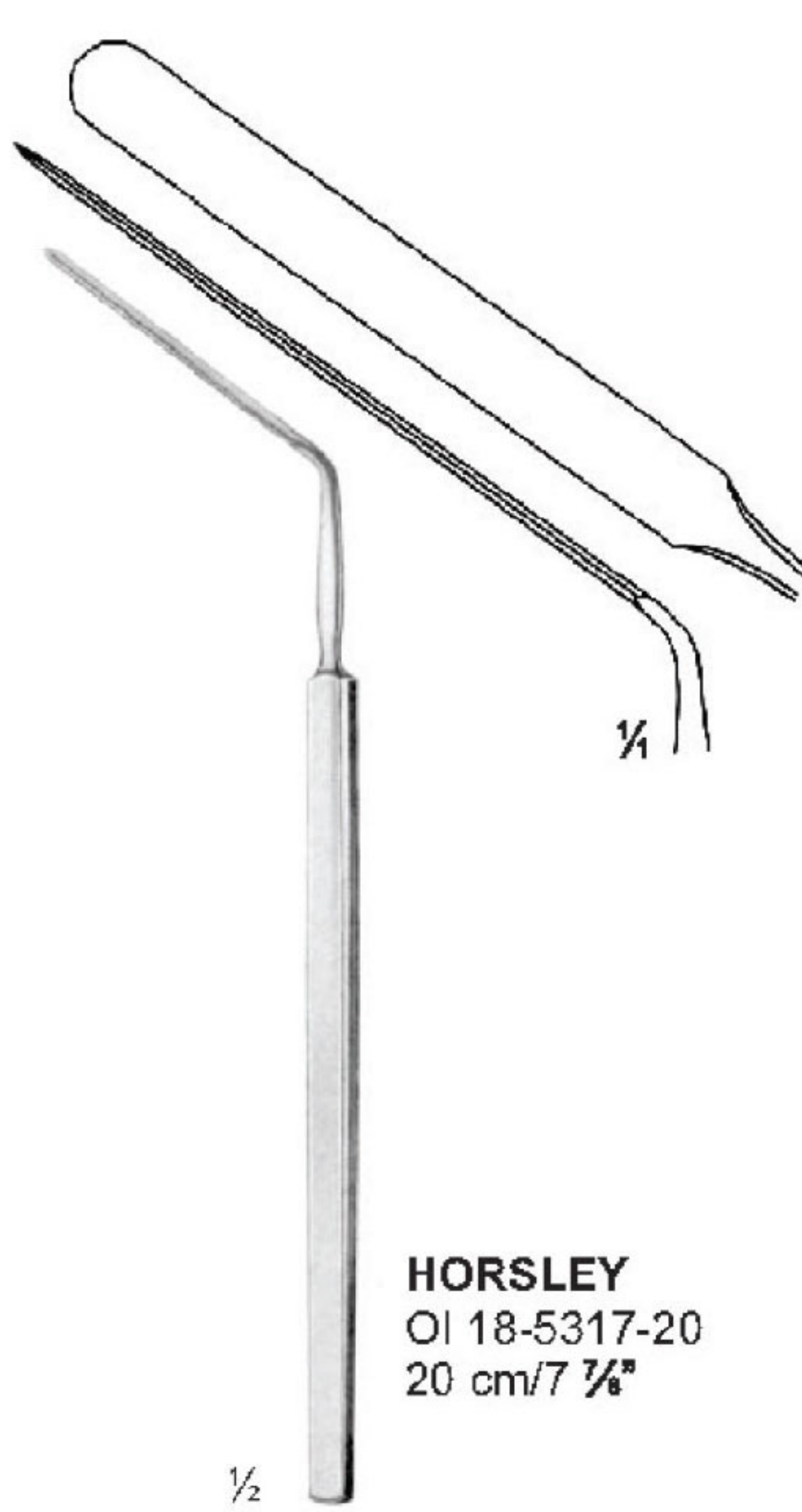

HORSLEY
 OI 18-5317-20
 20 cm/7 7/8"

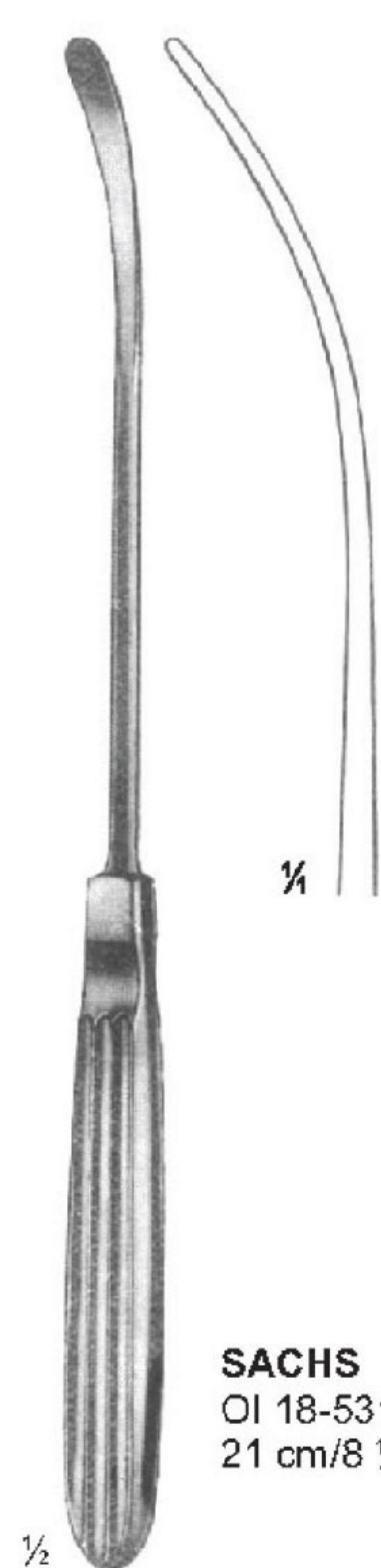

SACHS
 OI 18-5318-21
 21 cm/8 1/4"

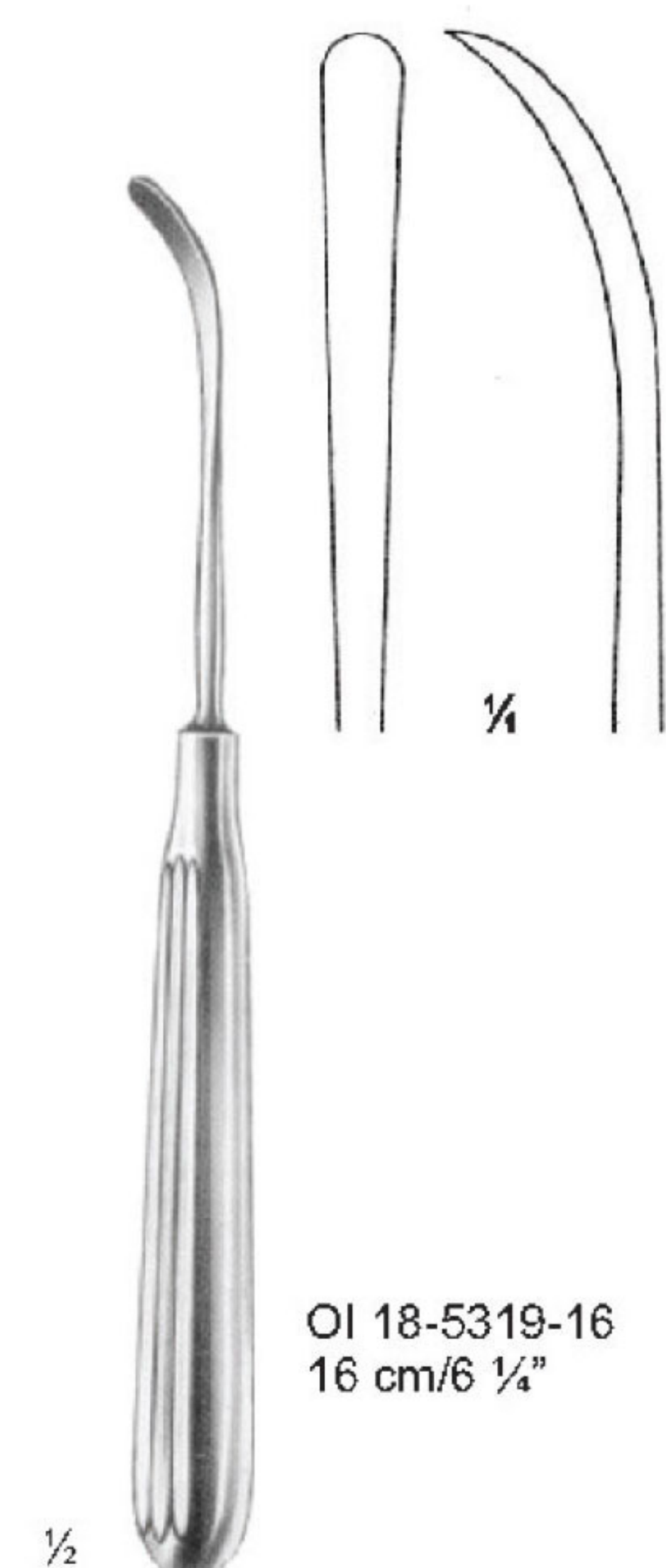

OI 18-5319-16
 16 cm/6 1/4"

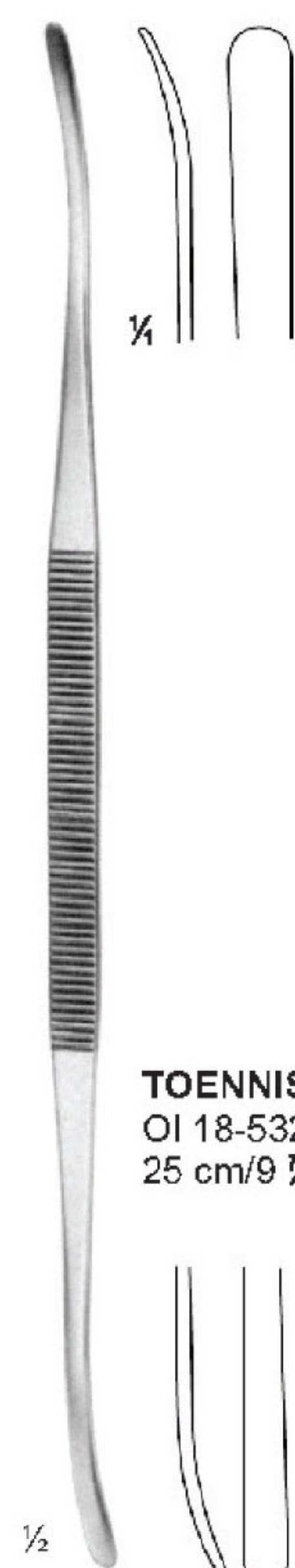

TOENNIS
 OI 18-5320-20
 25 cm/9 7/8"

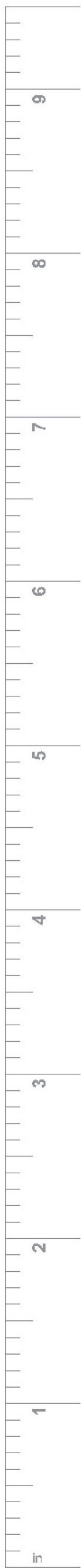

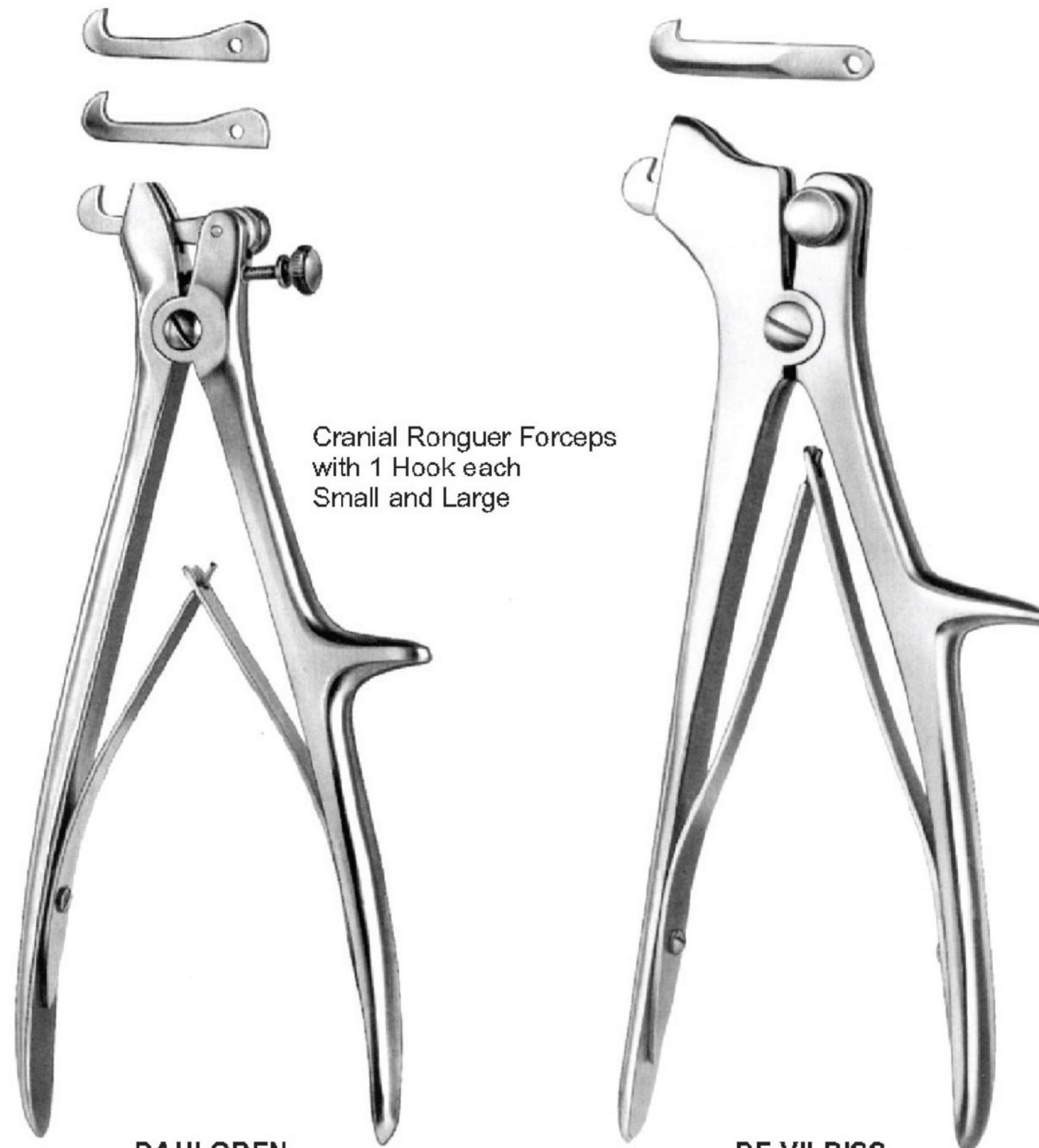

Cranial Ronguer Forceps
with 1 Hook each
Small and Large

DAHLGREN
OI 18-5321-20
20 cm/7 7/8"

DE VILBISS
OI 18-5322-21
21 cm/8 1/4"



McKENZIE
OI 18-5323-15 15cm/5 7/8"
OI 18-5323-19 19cm/7 1/2"

McKENZIE
OI 18-5324-15 15cm/5 7/8"
OI 18-5324-19 19cm/7 1/2"

RANEY
OI 18-5325
Applying and removing
forceps for scalp hemostasis clip

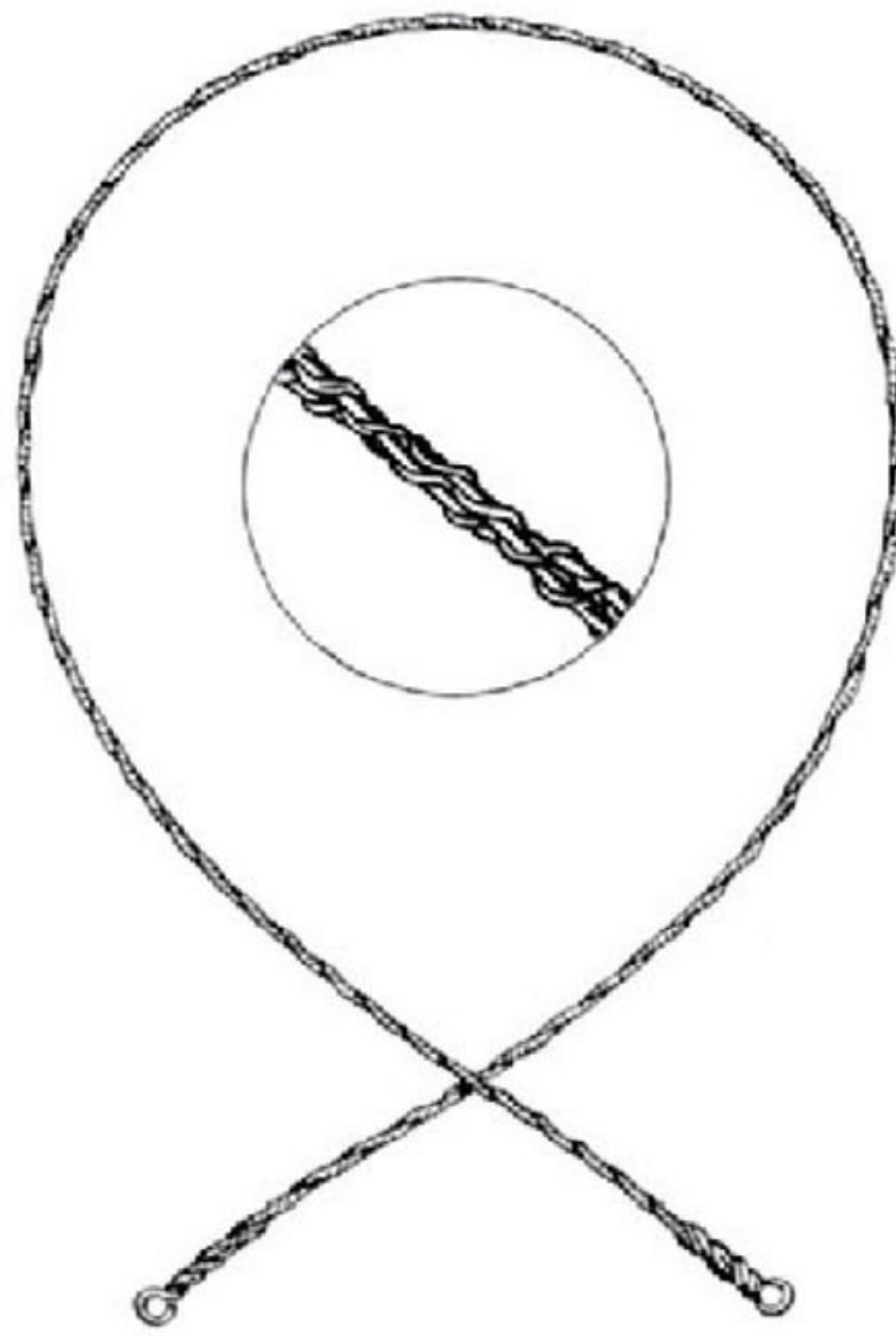

- OI 18-5326-30 30cm
- OI 18-5326-40 40cm
- OI 18-5326-50 50cm
- OI 18-5326-60 60cm
- OI 18-5326-70 70cm

GIGLI-WIRE SAW
2 wires twisted

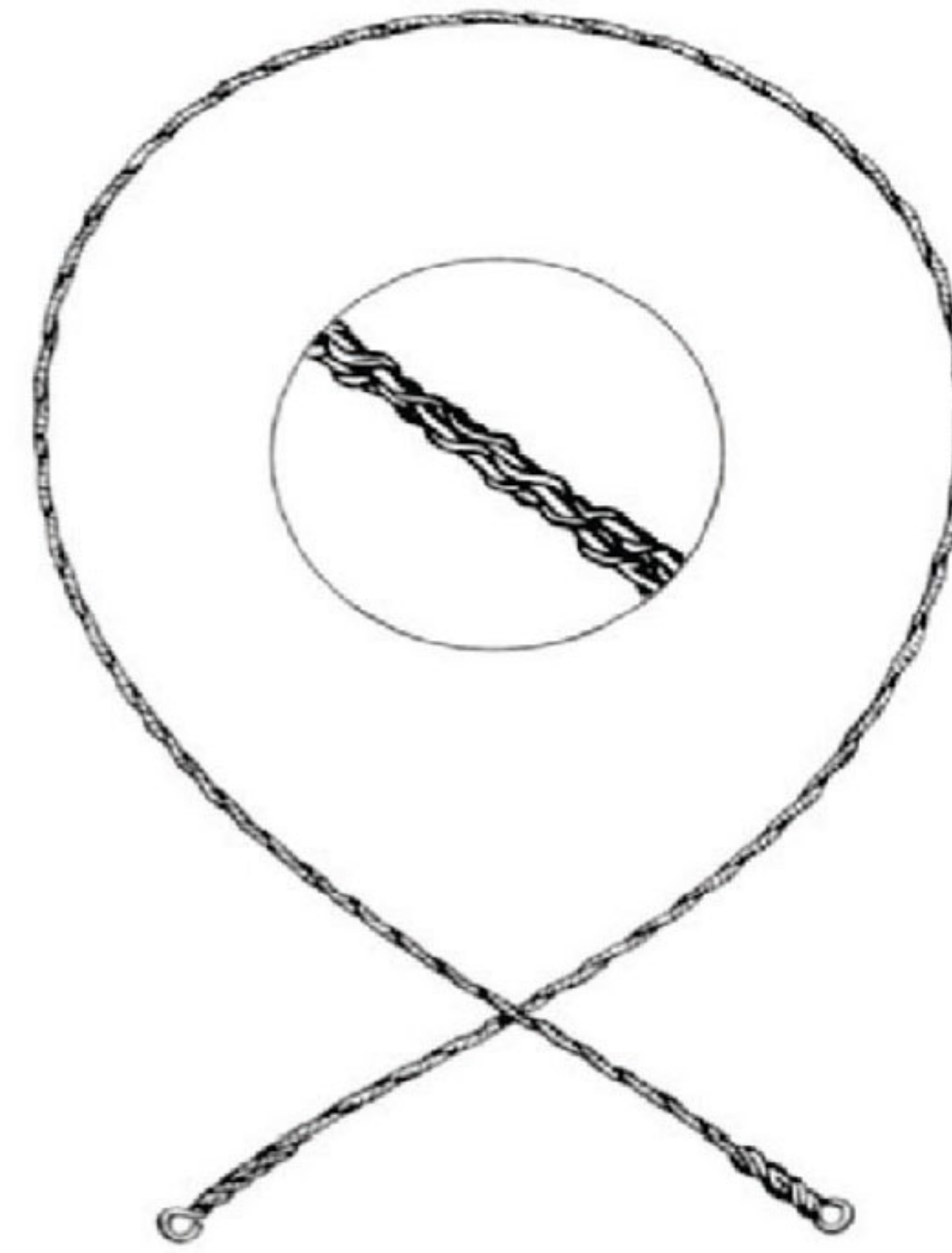

- OI 18-5327-30 30cm
- OI 18-5327-40 40cm
- OI 18-5327-50 50cm

GIGLI-WIRE SAW
6 wires twisted



GIGLI
OI 18-5328-07
7 cm/2 3/4"
Hook handle
for wire saw



De MARTEL
OI 18-5329-33
33 cm/13"
Conductor for
wire saws



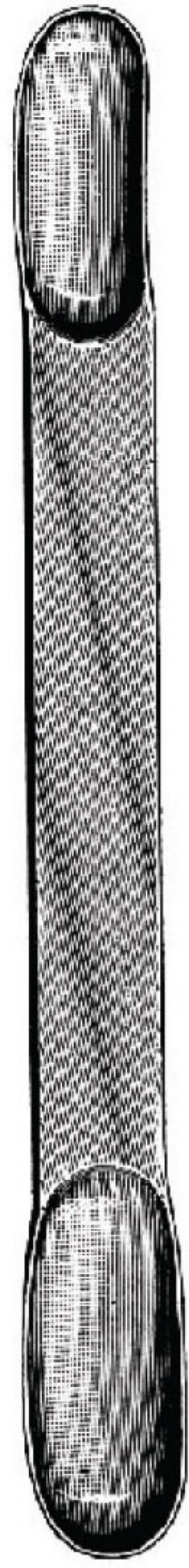

CUSHING
 OI 18-5330-17 17cm/6 3/4"
 OI 18-5330-20 20cm/7 1/8"
 OI 18-5330-28 28cm/11"

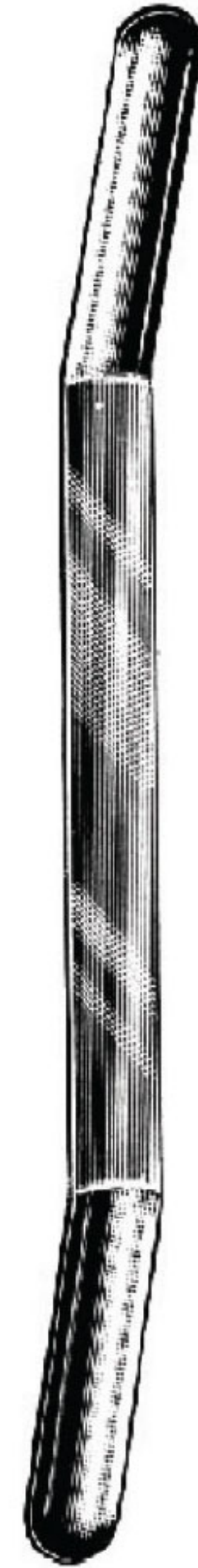

OLIVECRONA
 18 cm/7 1/8"
 width of spatulas

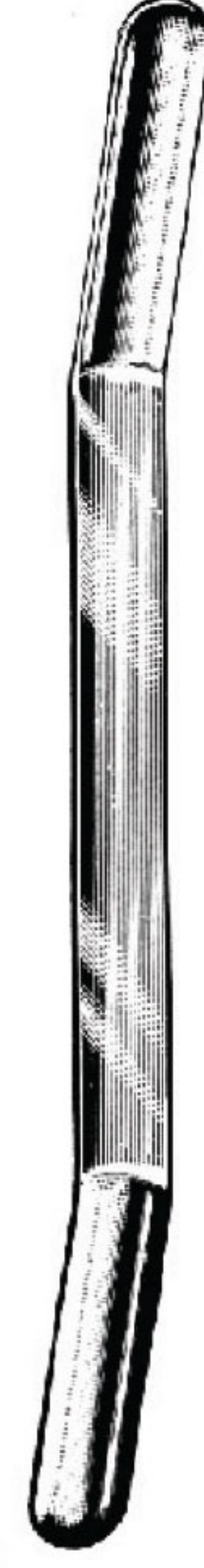

lower end

Concave
 OI 18-5331-18
 OI 18-5332-18
 OI 18-5333-18
 OI 18-5334-18

upper end
 7 + 9 mm
 11 + 13 mm
 15 + 18 mm
 18 + 22 mm

Convex
 OI 18-5335-18
 OI 18-5336-18
 OI 18-5337-18
 OI 18-5338-18



SCOVILLE
 OI 18-5339-23
 23 cm/9"

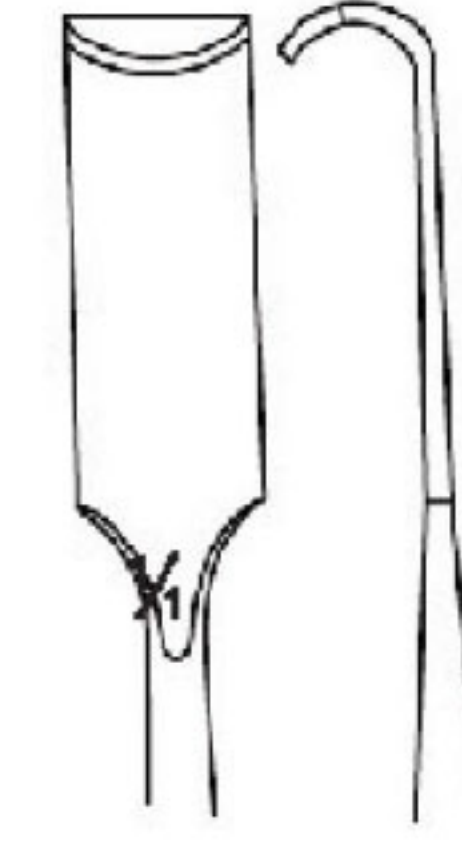

HOLSHER
 OI 18-5340-24
 24 cm/9 1/2"

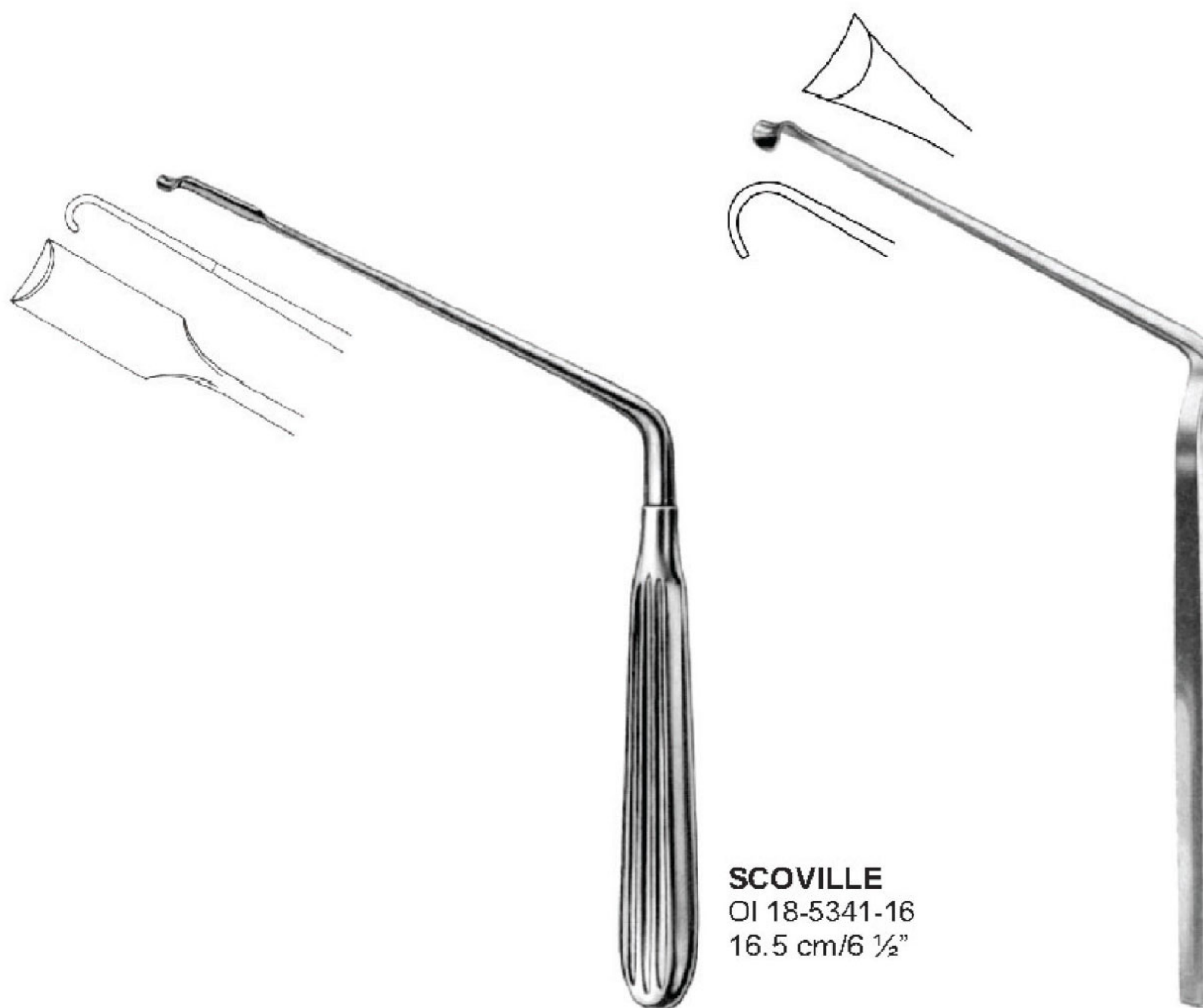

SCOVILLE
 OI 18-5341-16
 16.5 cm/6 1/2"

OI 18-5342-21
 21 cm/8 1/4"

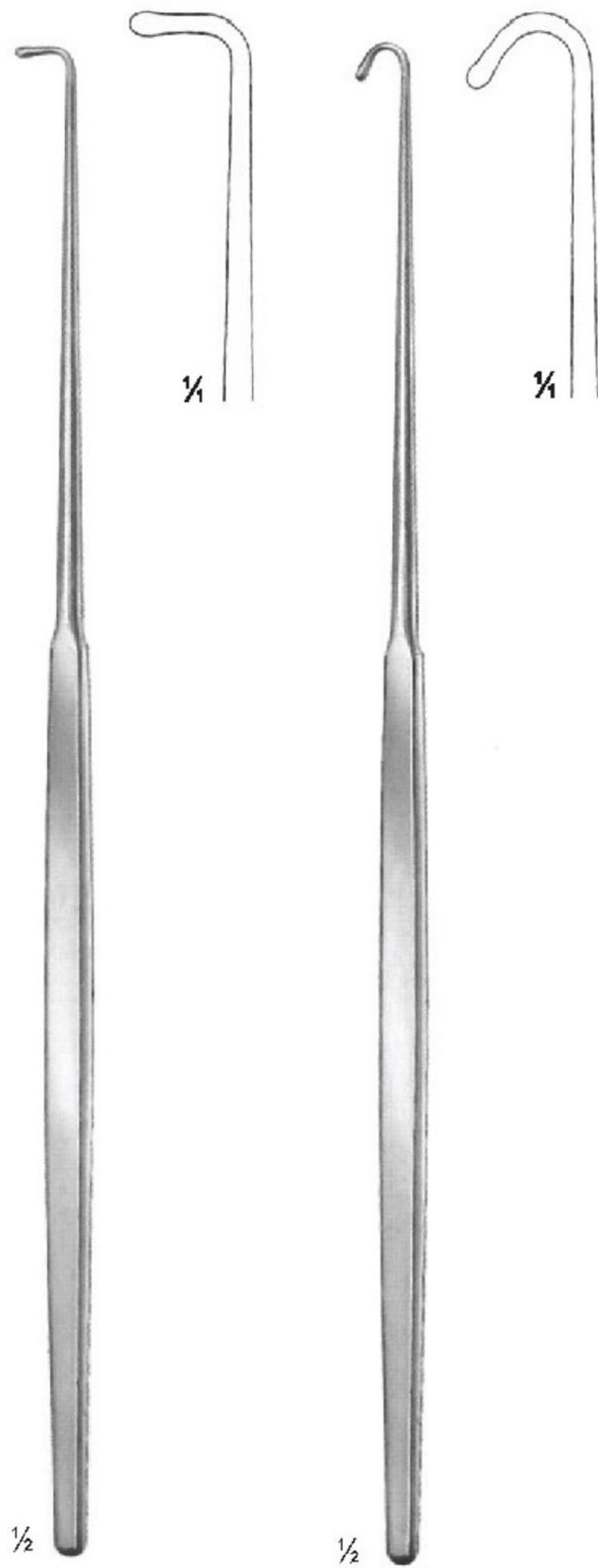

GRONINGEN
 OI 18-5343-26
 26.5 cm/10 3/8"

GRONINGEN
 OI 18-5344-26
 26.5 cm/10 3/8"



CUSHING

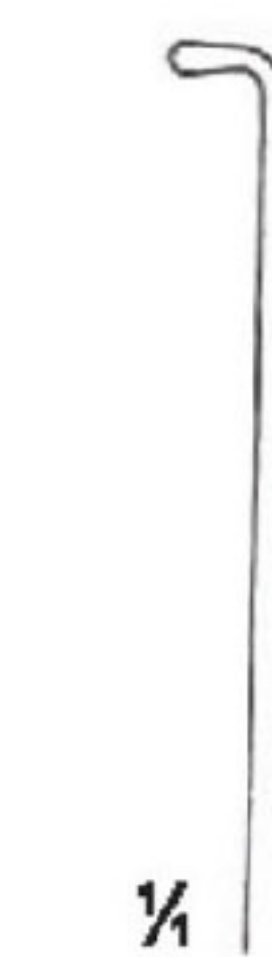

Fig. 1
 OI 18-5345-19
 19 cm/7 1/2"

Fig. 1
 OI 18-5345-28
 28 cm/11"



CUSHING



Fig. 2
 OI 18-5346-19
 19 cm/7 1/2"

Fig. 2
 OI 18-5346-28
 28 cm/11"



SMITHWICK



DF-237-2787
 17 cm/6 3/4"



OI 18-5347-21
 21 cm/8 1/4"



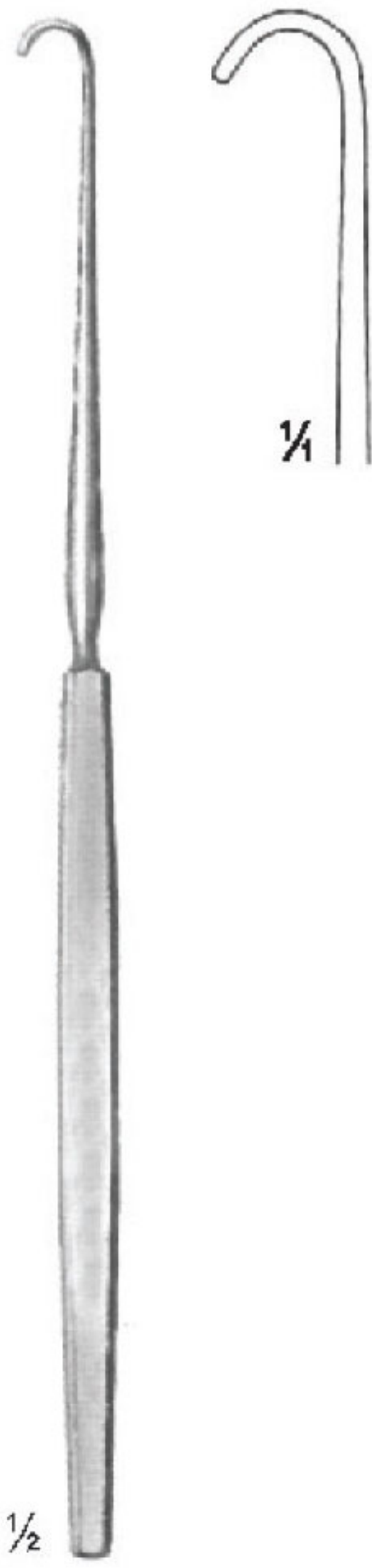

GRAHAM
OI 18-5348-16
16.5 cm/6 1/2"



SACHS
OI 18-5349-17
17 cm/6 3/4"



FRAZIER

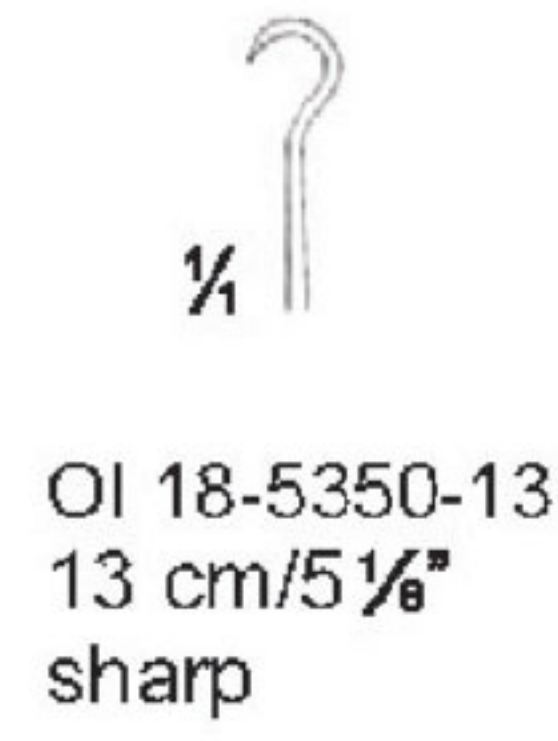

OI 18-5350-13
13 cm/5 1/8"
sharp



OI 18-5350-18
18 cm/7 1/8"
sharp



ADSON
OI 18-5351-20
20 cm/7 7/8"



KRAYENBÜHL
19 cm / 7 1/2"



Fig. 1
OI 18-5352-19



Fig. 2
OI 18-5353-19

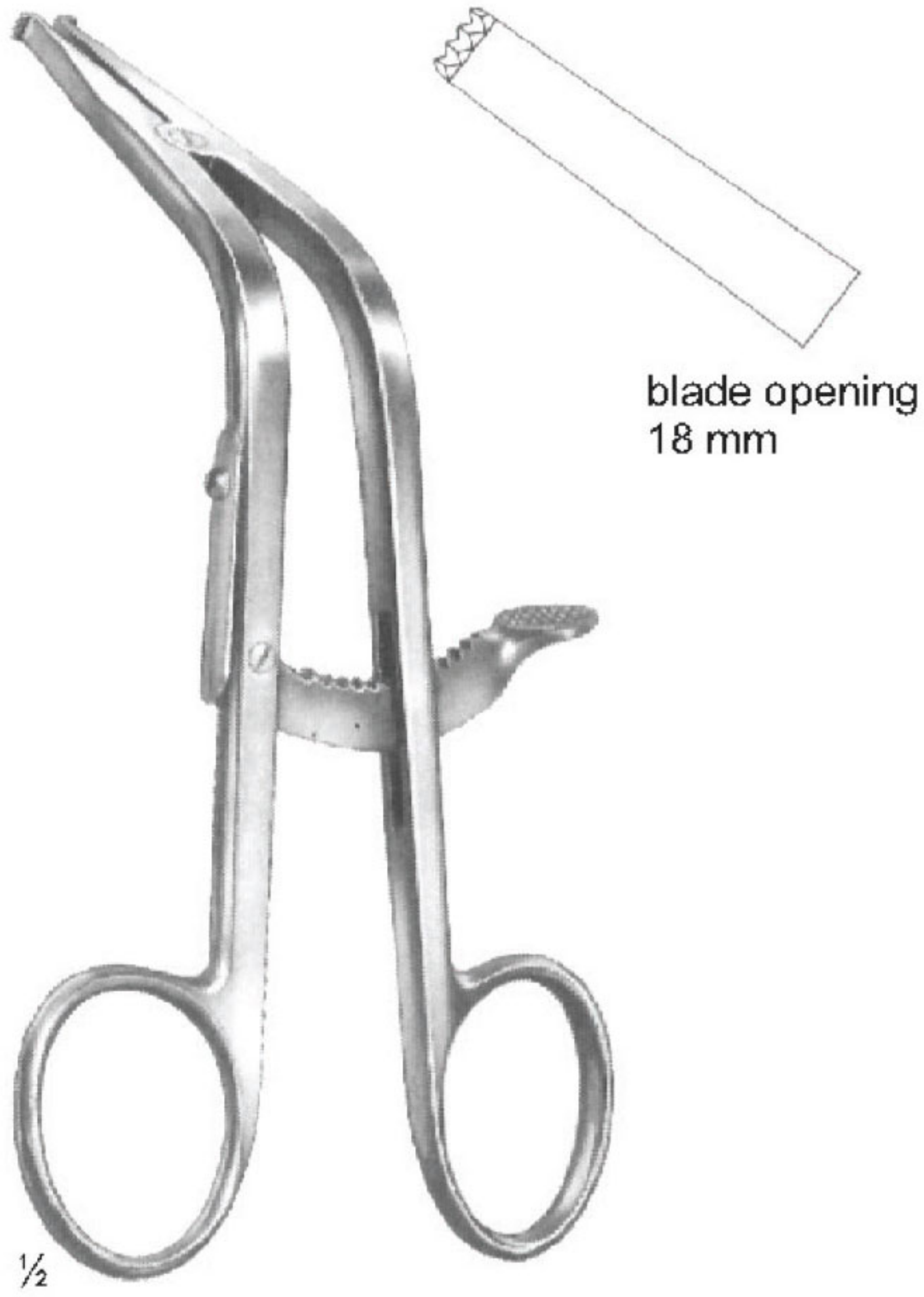

Fig. 1
OI 18-5354-19

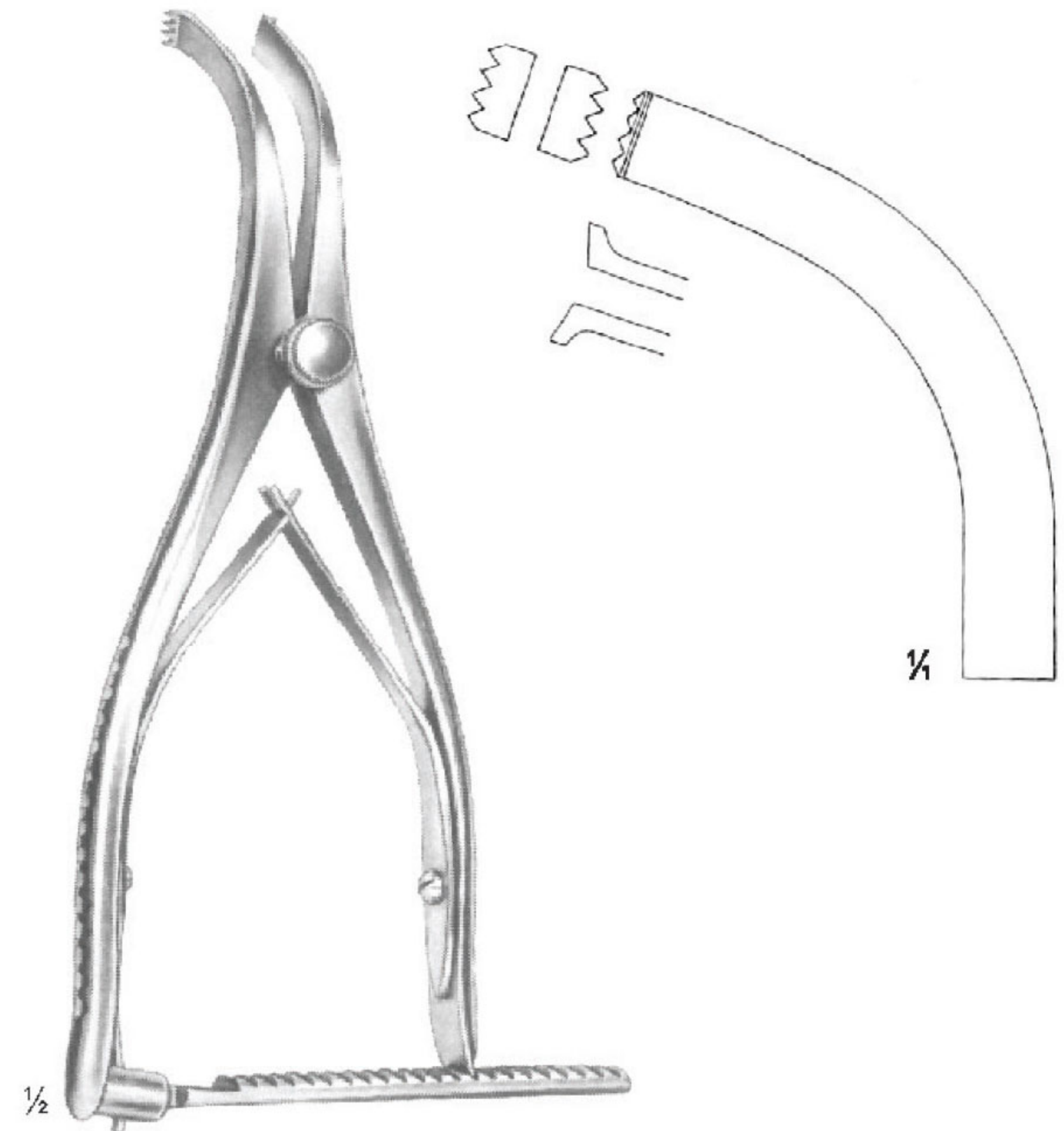

Fig. 2
OI 18-5355-19





CLOWARD
 OI 18-5356-16
 16 cm/6 1/4"



INGE
 OI 18-5357-16
 16.5 cm/6 1/2"
 Blade opening 35 mm

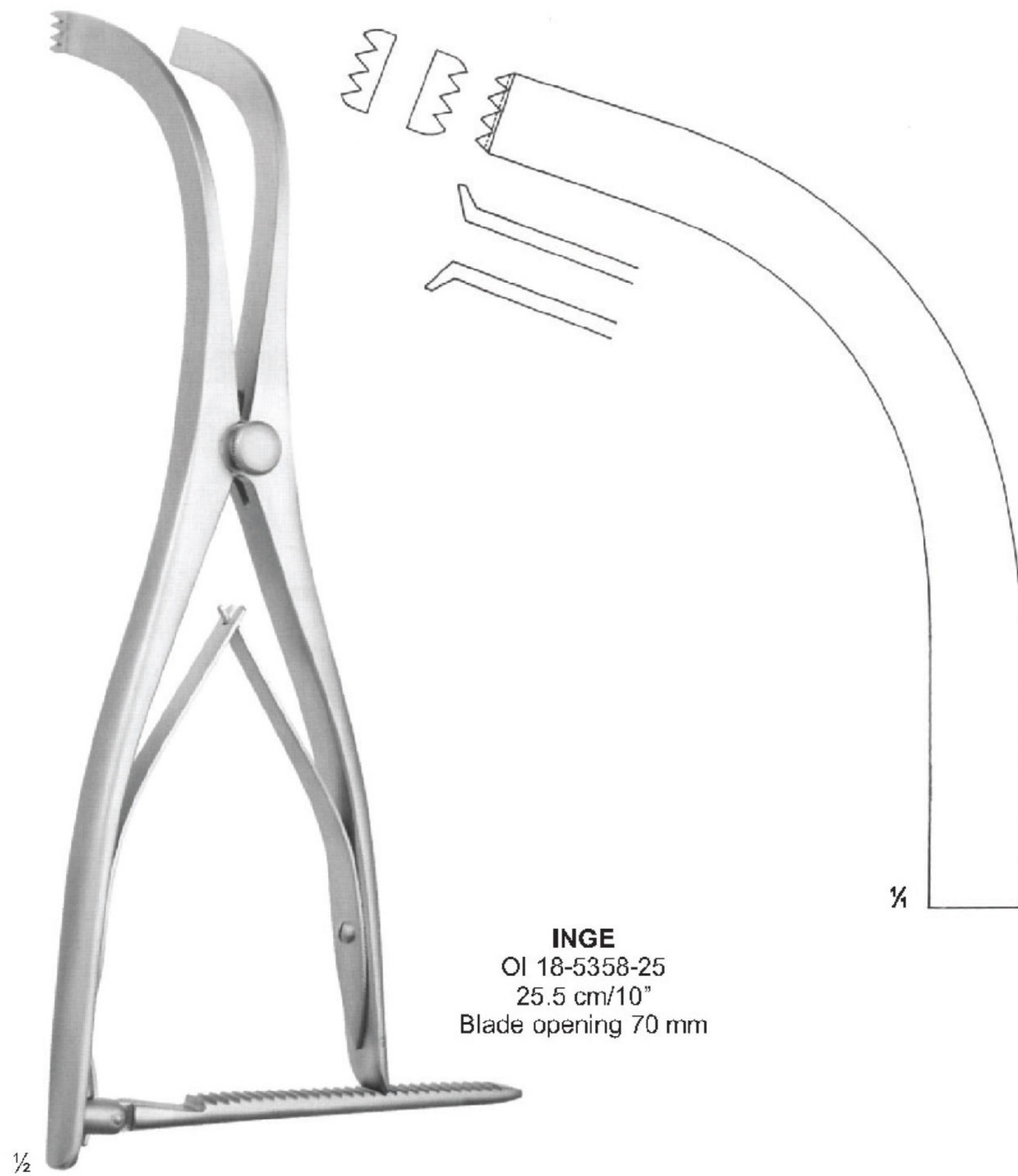

INGE
 OI 18-5358-25
 25.5 cm/10"
 Blade opening 70 mm

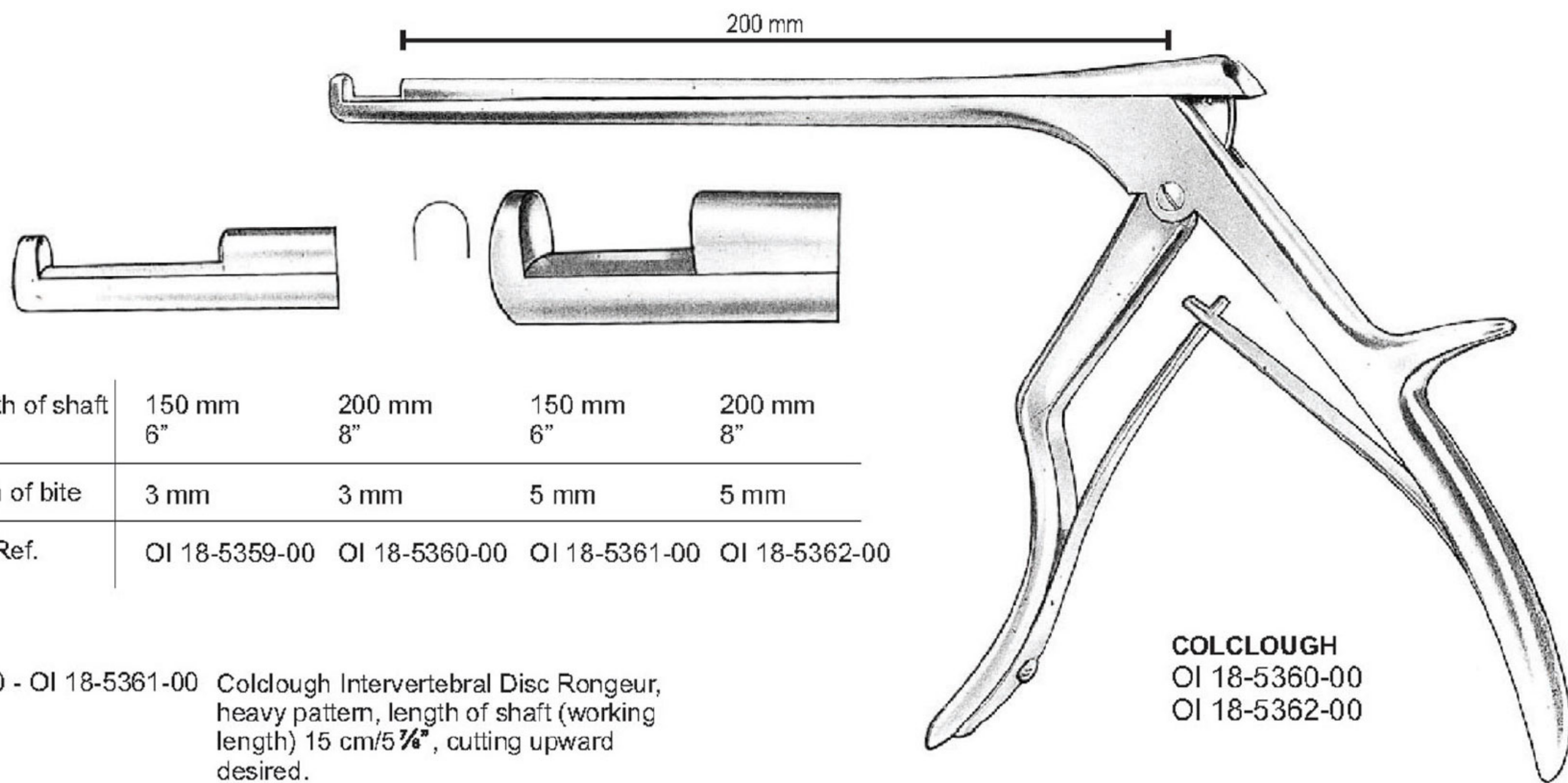
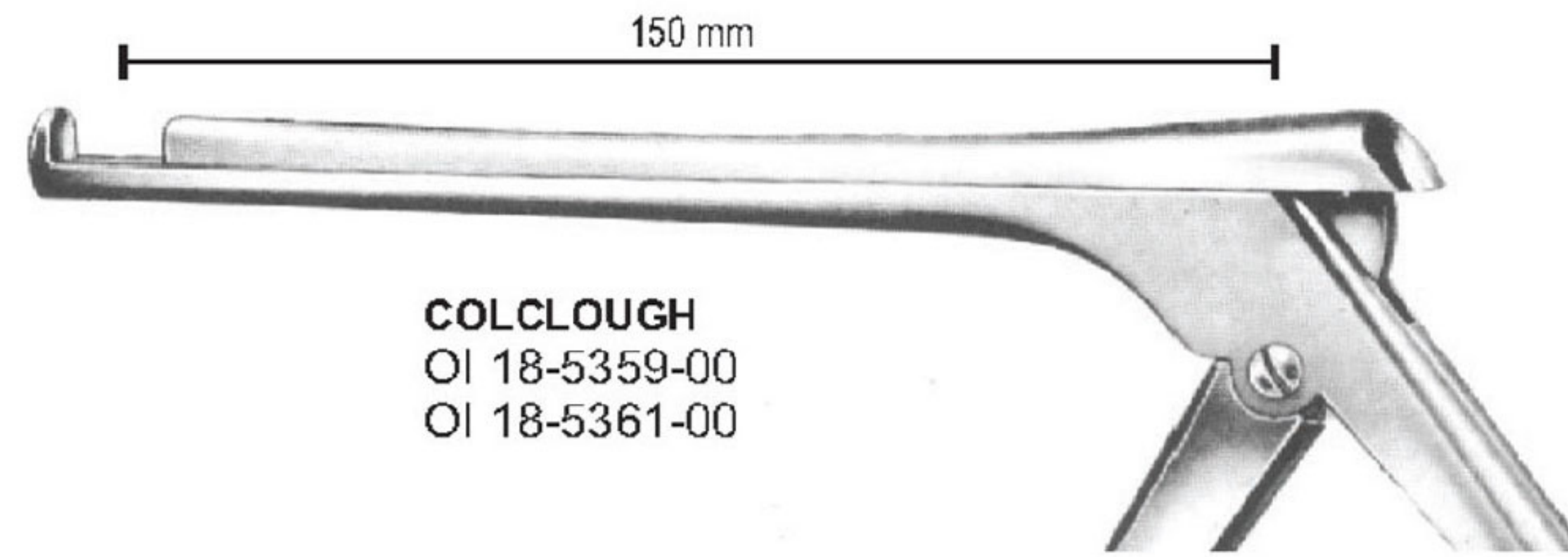

Length of shaft	150 mm 6"	200 mm 8"	150 mm 6"	200 mm 8"
Width of bite	3 mm	3 mm	5 mm	5 mm
Cat. Ref.	OI 18-5359-00	OI 18-5360-00	OI 18-5361-00	OI 18-5362-00

- OI 18-5359-00 - OI 18-5361-00 Colclough Intervertebral Disc Rongeur, heavy pattern, length of shaft (working length) 15 cm/5 7/8", cutting upward desired.
- OI 18-5360-00 - OI 18-5362-00 ditto, length of shaft (working length) 20 cm/7 7/8"
- OI 18-5362-00 - OI 18-5363-00 ditto, length of shaft (working length) 15 cm/5 7/8", cutting downward
- OI 18-5362-00 - OI 18-5362-00 ditto, length of shaft (working length) 20 cm/7 7/8"

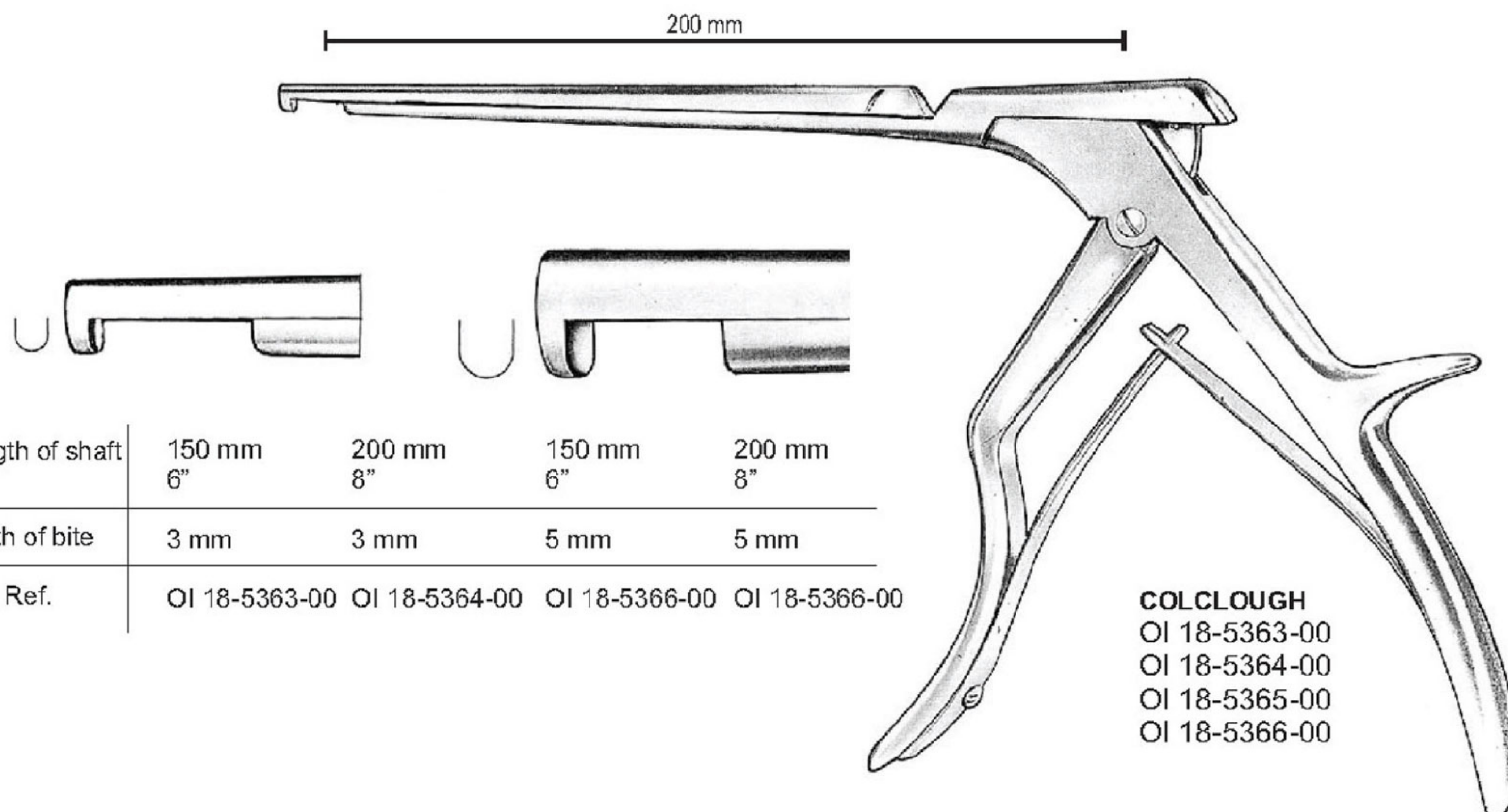
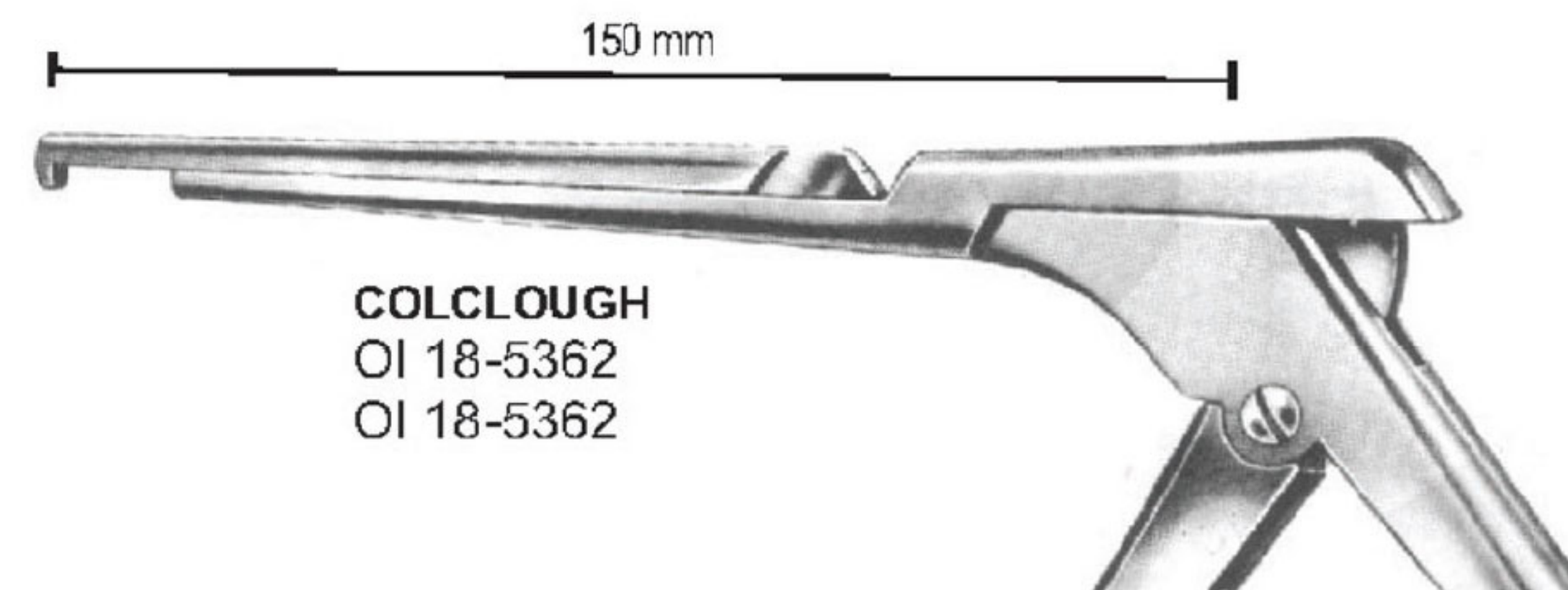

Length of shaft	150 mm 6"	200 mm 8"	150 mm 6"	200 mm 8"
Width of bite	3 mm	3 mm	5 mm	5 mm
Cat. Ref.	OI 18-5363-00	OI 18-5364-00	OI 18-5366-00	OI 18-5366-00

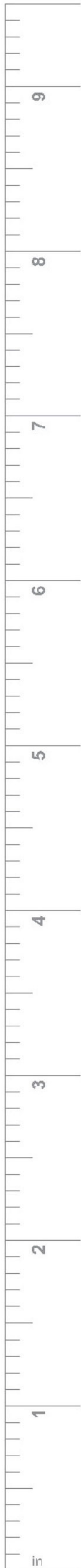

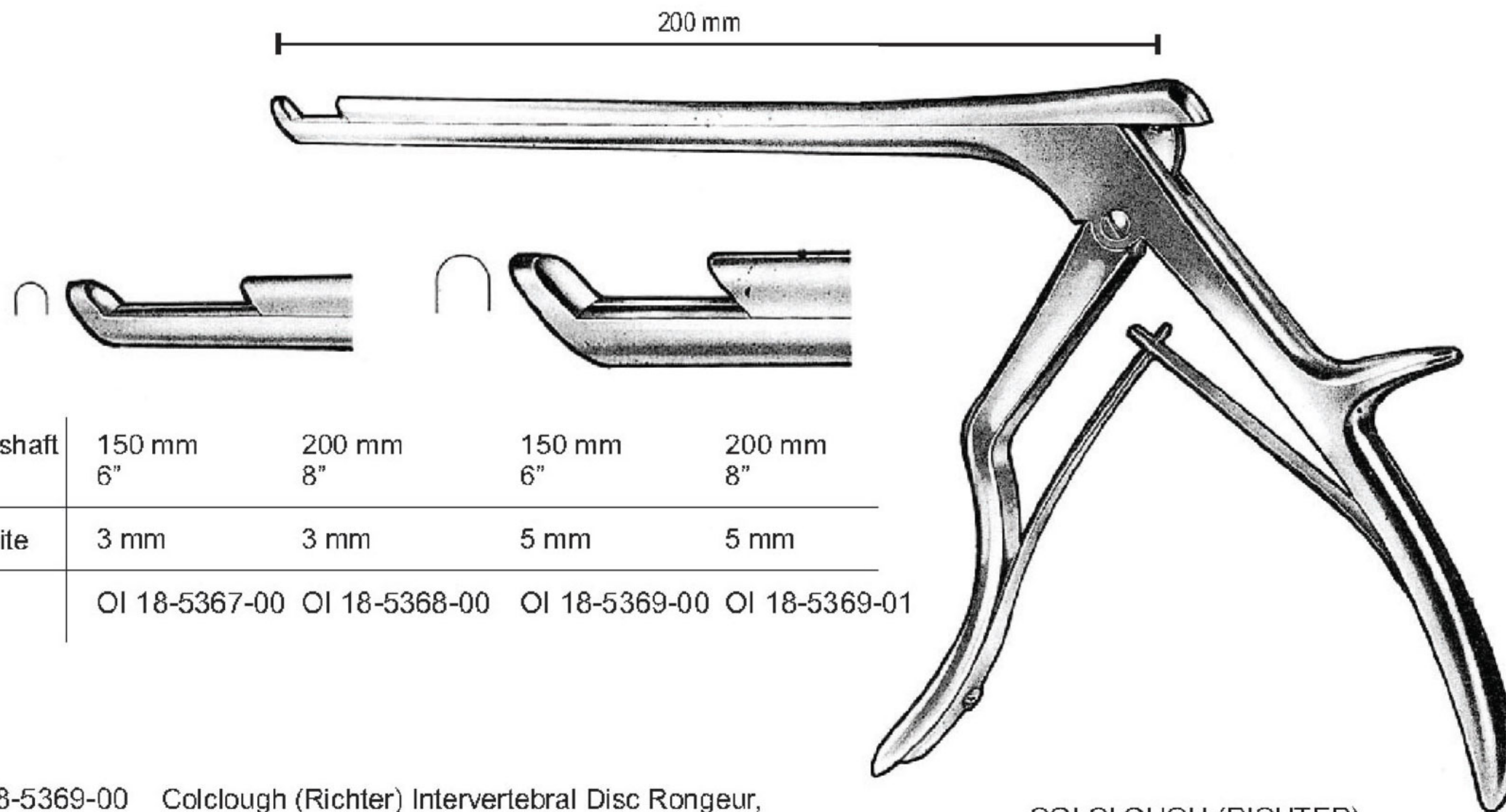
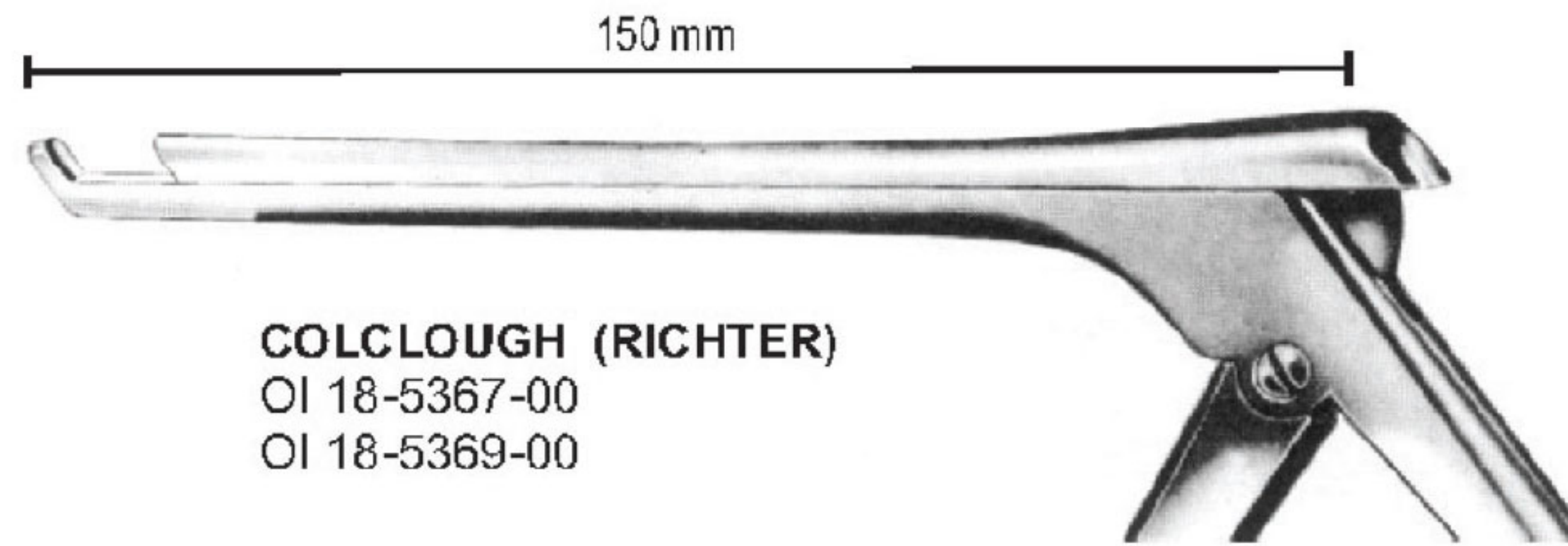

Length of shaft	150 mm 6"	200 mm 8"	150 mm 6"	200 mm 8"
Width of bite	3 mm	3 mm	5 mm	5 mm
Cat. Ref.	OI 18-5367-00	OI 18-5368-00	OI 18-5369-00	OI 18-5369-01

OI 18-5367-00 - OI 18-5369-00 Colclough (Richter) Intervertebral Disc Rongeur, heavy pattern, length of shaft (working length) 15 cm/6", cutting 40° forward

OI 18-5368-00 - OI 18-5369-01 ditto, length of shaft (working length) 20 cm/7 7/8"

COLCLOUGH (RICHTER)
OI 18-5368-00
OI 18-5369-01

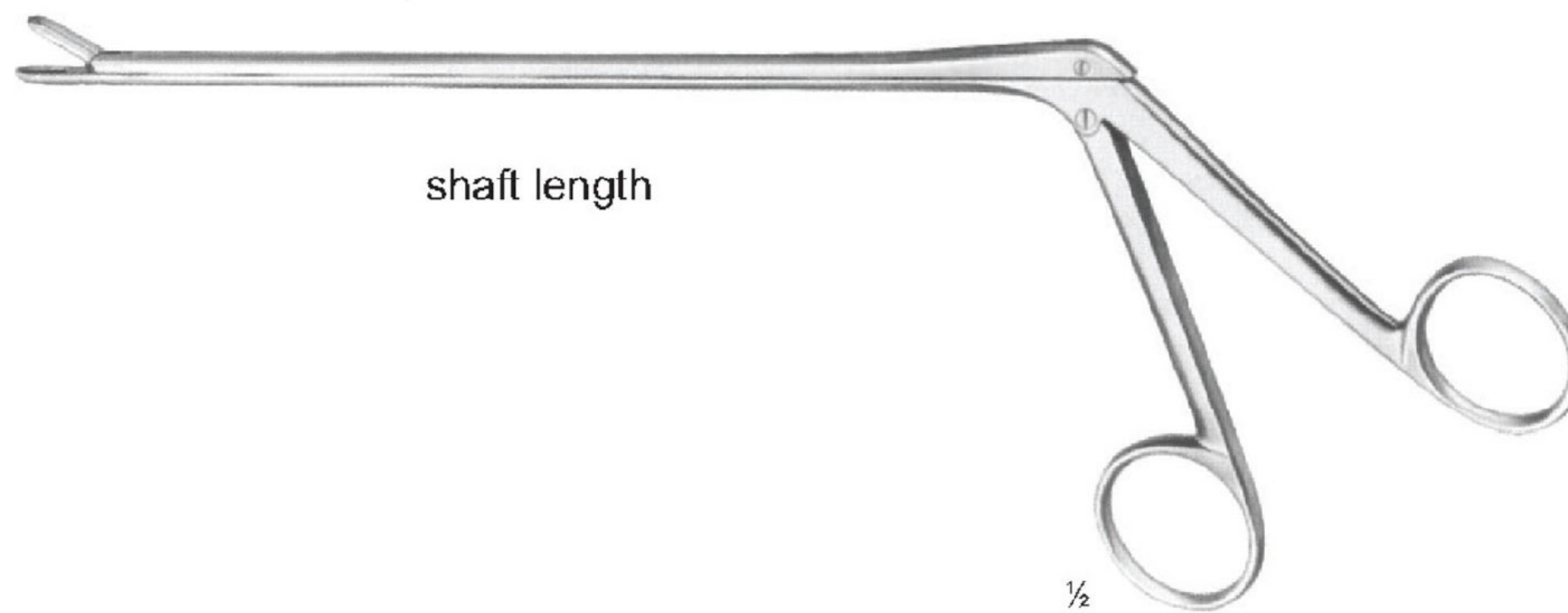

CUSHING
straight

OI 18-5370-12 120 mm
 OI 18-5370-15 150 mm
 OI 18-5370-18 180 mm

CUSHING
upwards

OI 18-5371-12 120 mm
 OI 18-5371-15 150 mm
 OI 18-5371-18 180 mm

CUSHING
downwards

OI 18-5372-12 120 mm
 OI 18-5372-15 150 mm
 OI 18-5372-18 180 mm

LOVE-GRUENWALD
straight

OI 18-5373-12 120 mm
 OI 18-5373-15 150 mm
 OI 18-5373-18 180 mm

LOVE-GRUENWALD
upwards

OI 18-5374-12 120 mm
 OI 18-5374-15 150 mm
 OI 18-5374-18 180 mm

LOVE-GRUENWALD
downwards

OI 18-5375-12 120 mm
 OI 18-5375-15 150 mm
 OI 18-5375-18 180 mm

SPURLING
straight

OI 18-5376-12 120 mm
 OI 18-5376-15 150 mm
 OI 18-5376-18 180 mm

SPURLING
upwards

OI 18-5377-12 120 mm
 OI 18-5377-15 150 mm
 OI 18-5377-18 180 mm

SPURLING
downwards

OI 18-5378-12 120 mm
 OI 18-5378-15 150 mm
 OI 18-5378-18 180 mm

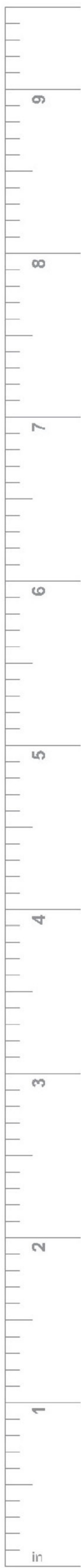

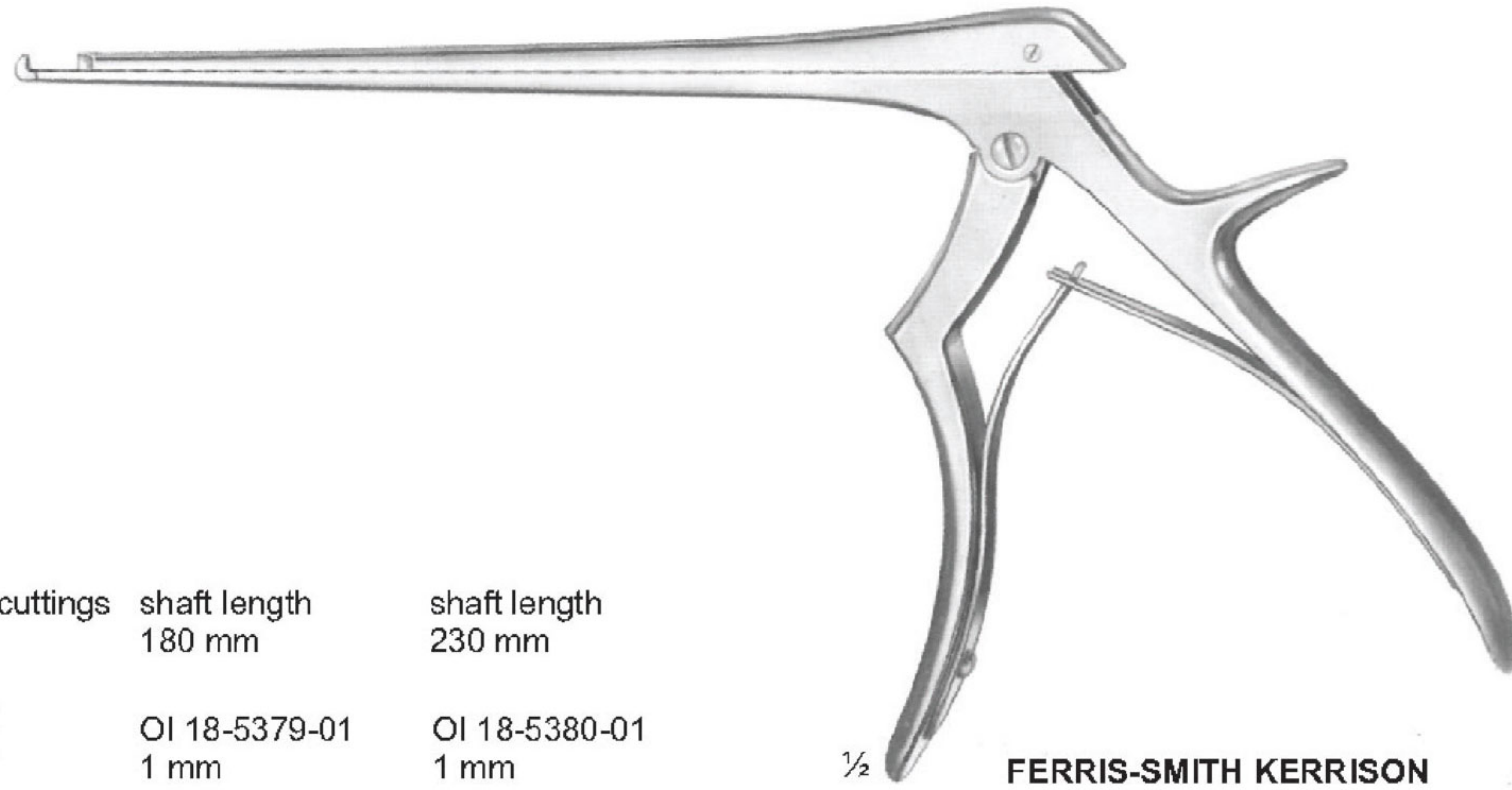

upwards cuttings	shaft length 180 mm	shaft length 230 mm
	OI 18-5379-01 1 mm	OI 18-5380-01 1 mm
	OI 18-5379-02 2 mm	OI 18-5380-02 2 mm
	OI 18-5379-03 3 mm	OI 18-5380-03 3 mm
	OI 18-5379-04 4 mm	OI 18-5380-04 4 mm
	OI 18-5379-05 5 mm	OI 18-5380-05 5 mm
	OI 18-5379-06 6 mm	OI 18-5380-06 6 mm











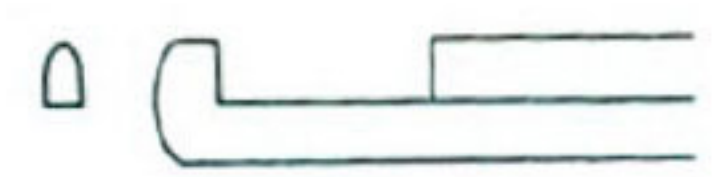

downwards cuttings	shaft length 180 mm
	OI 18-5383-03 3 mm

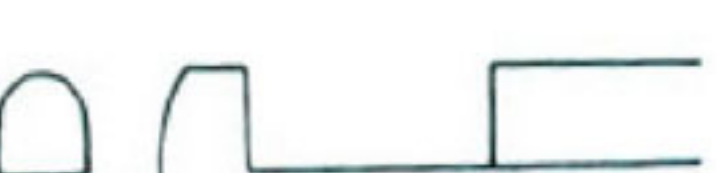
downwards cuttings	shaft length 180 mm	shaft length 230 mm
	OI 18-5381-01 1 mm	OI 18-5382-01 1 mm
	OI 18-5381-02 2 mm	OI 18-5382-02 2 mm
	OI 18-5383-03 3 mm	OI 18-5382-03 3 mm
	OI 18-5383-04 4 mm	OI 18-5382-04 4 mm
	OI 18-5383-05 5 mm	OI 18-5382-05 5 mm
	OI 18-5383-06 6 mm	OI 18-5382-06 6 mm

upwards cuttings	shaft length 180 mm	shaft length 230 mm
	OI 18-5384-01 1 mm	OI 18-5385-01 1 mm
	OI 18-5384-02 2 mm	OI 18-5385-02 2 mm
	OI 18-5384-03 3 mm	OI 18-5385-03 3 mm
	OI 18-5384-04 4 mm	OI 18-5385-04 4 mm
	OI 18-5384-05 5 mm	OI 18-5385-05 5 mm
	OI 18-5384-06 6 mm	OI 18-5385-06 6 mm



FERRIS-SMITH KERRISON

upwards cuttings	shaft length 180 mm	shaft length 230 mm	upwards cuttings	shaft length 180 mm	shaft length 230 mm
	OI 18-5386-1 1 mm	OI 18-5387-1 1 mm		OI 18-5388-1 1 mm	OI 18-5389-1 1 mm
	OI 18-5386-2 2 mm	OI 18-5387-2 2 mm		OI 18-5388-2 2 mm	OI 18-5389-2 2 mm
	OI 18-5386-3 3 mm	OI 18-5387-3 3 mm		OI 18-5388-3 3 mm	OI 18-5389-3 3 mm
	OI 18-5386-4 4 mm	OI 18-5387-4 4 mm		OI 18-5388-4 4 mm	OI 18-5389-4 4 mm
	OI 18-5386-5 5 mm	OI 18-5387-5 5 mm		OI 18-5388-5 5 mm	OI 18-5389-5 5 mm
	OI 18-5386-6 6 mm	OI 18-5387-6 6 mm		OI 18-5388-6 6 mm	OI 18-5389-6 6 mm



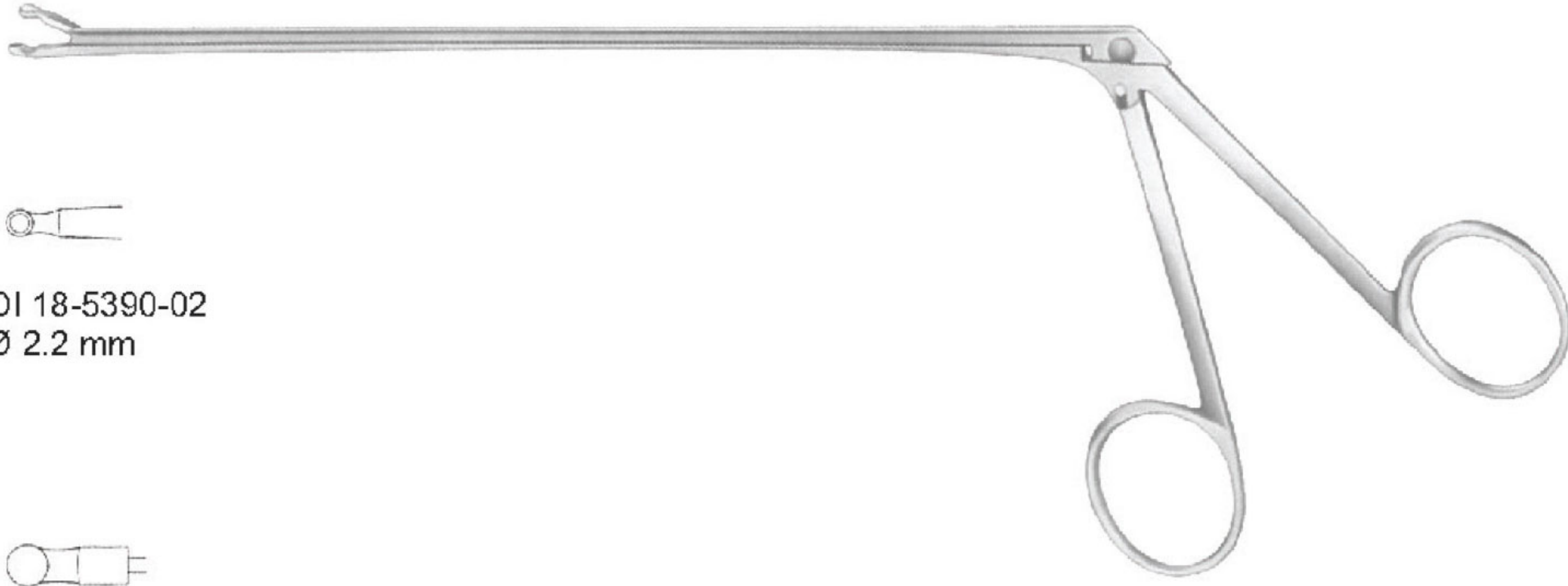

OI 18-5390-02
Ø 2.2 mm

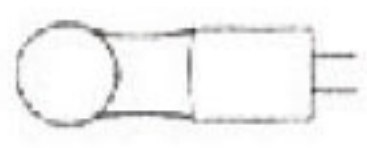

OI 18-5390-03
Ø 3.5 mm

YASARGIL

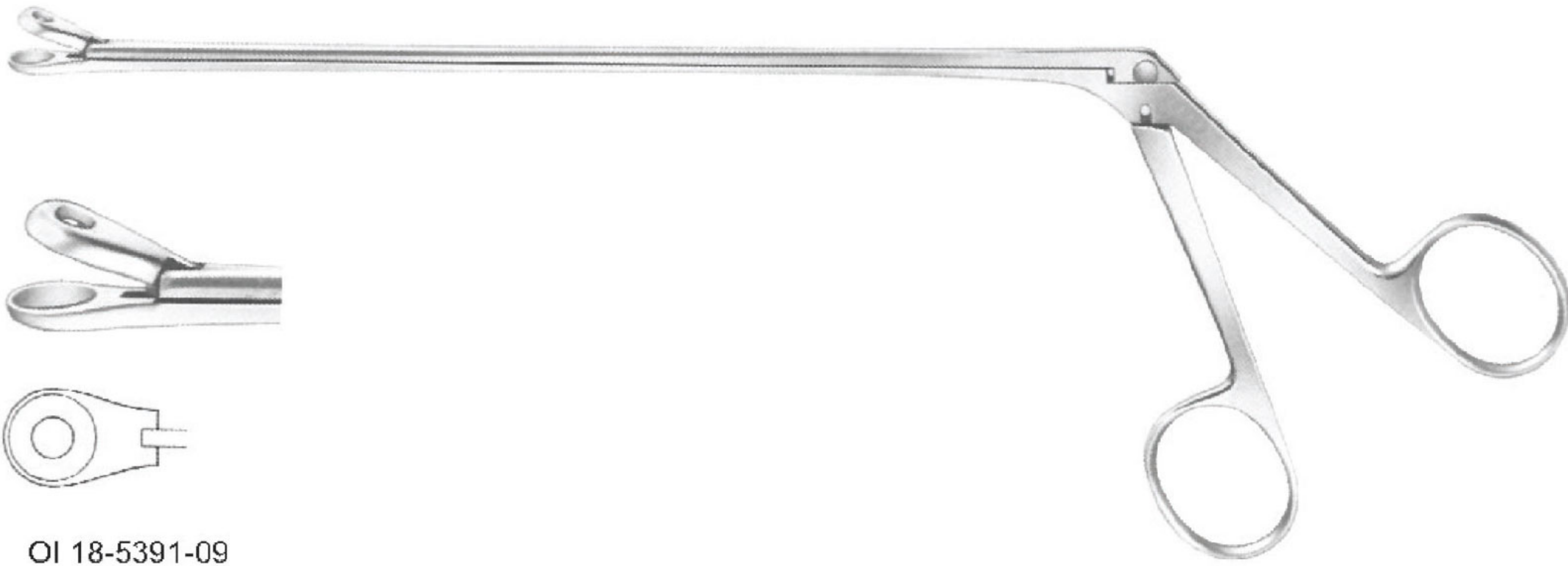

OI 18-5391-09
Ø 9.0 mm

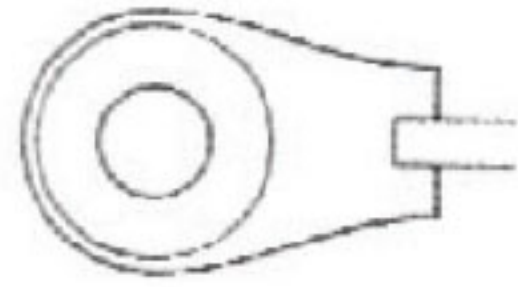
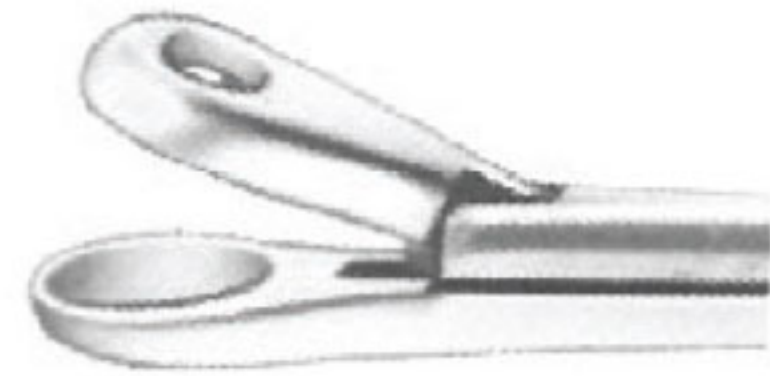

LANDOLT
Tumor grasping forceps, blunt

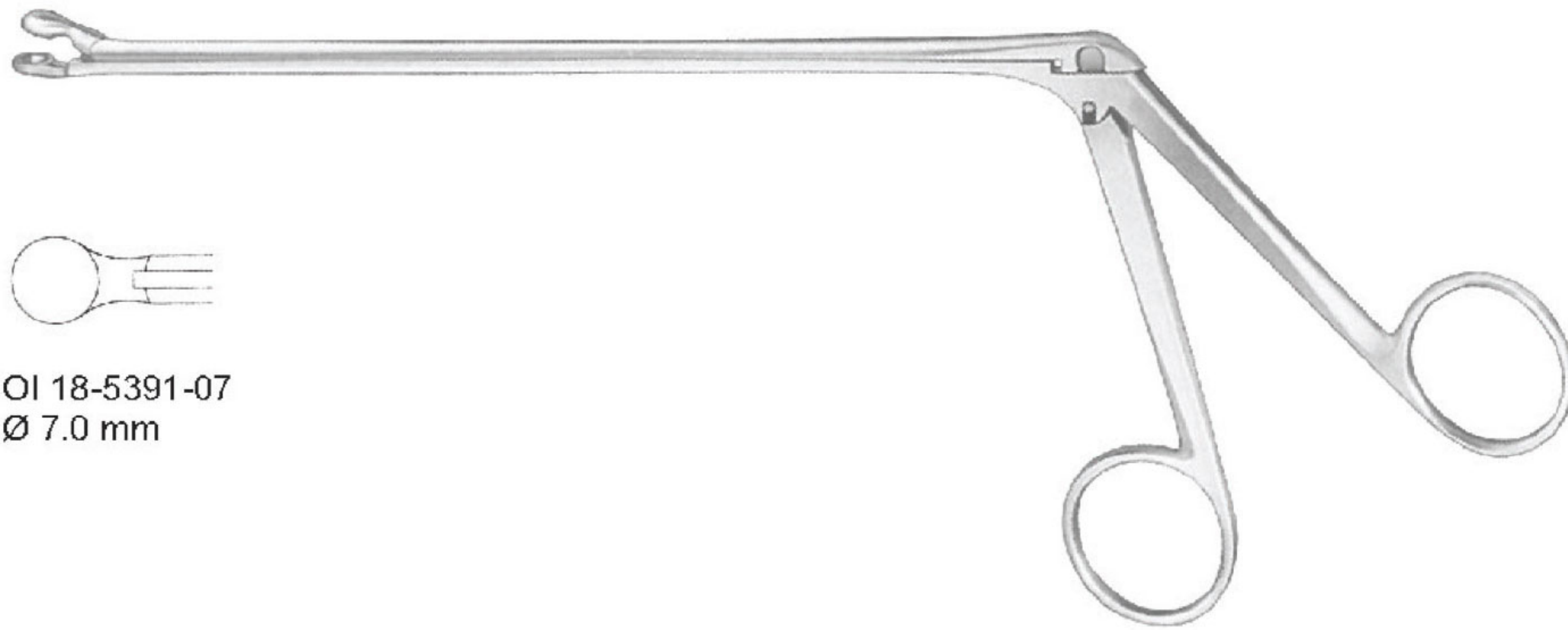

OI 18-5391-07
Ø 7.0 mm

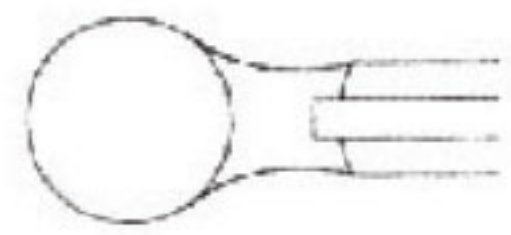

OLDBERG