

EN TC Scissors

DE TC Scheren

ES Tijeras TC

Page 75 to 84



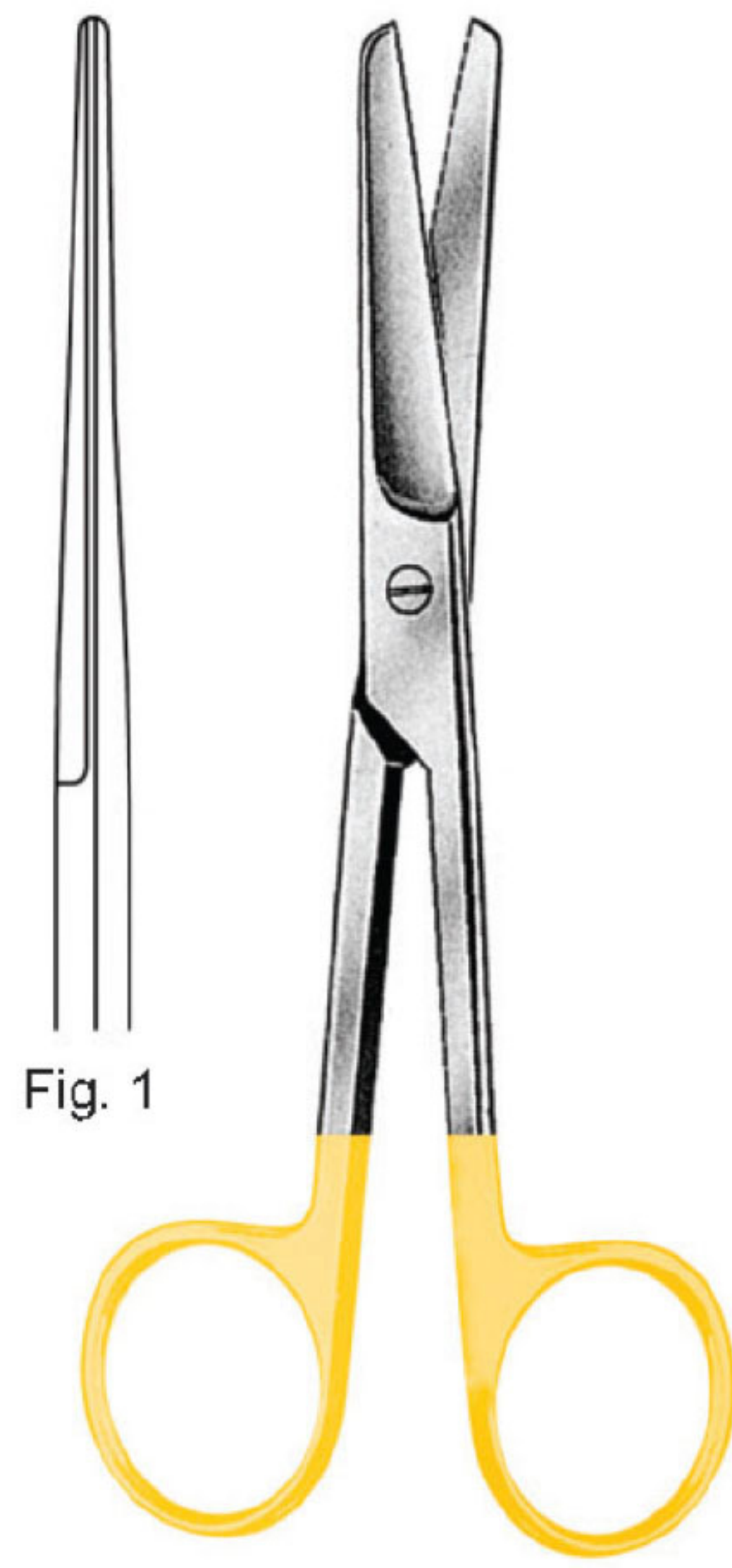

Fig. 1

STANDARD
OI 06-1801-14
14.5 cm/5 ¾"

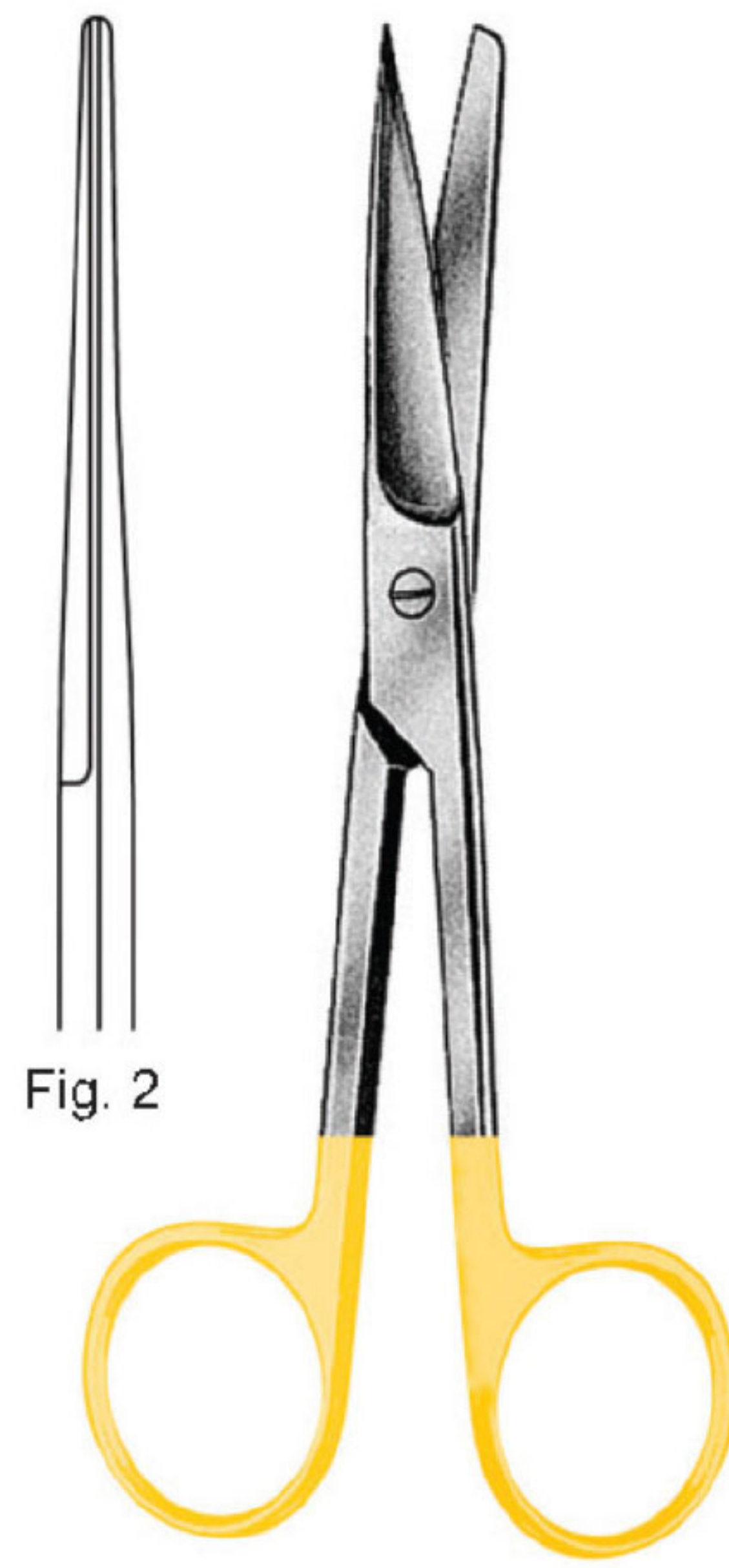

Fig. 2

STANDARD
OI 06-1802-14
14.5 cm/5 ¾"

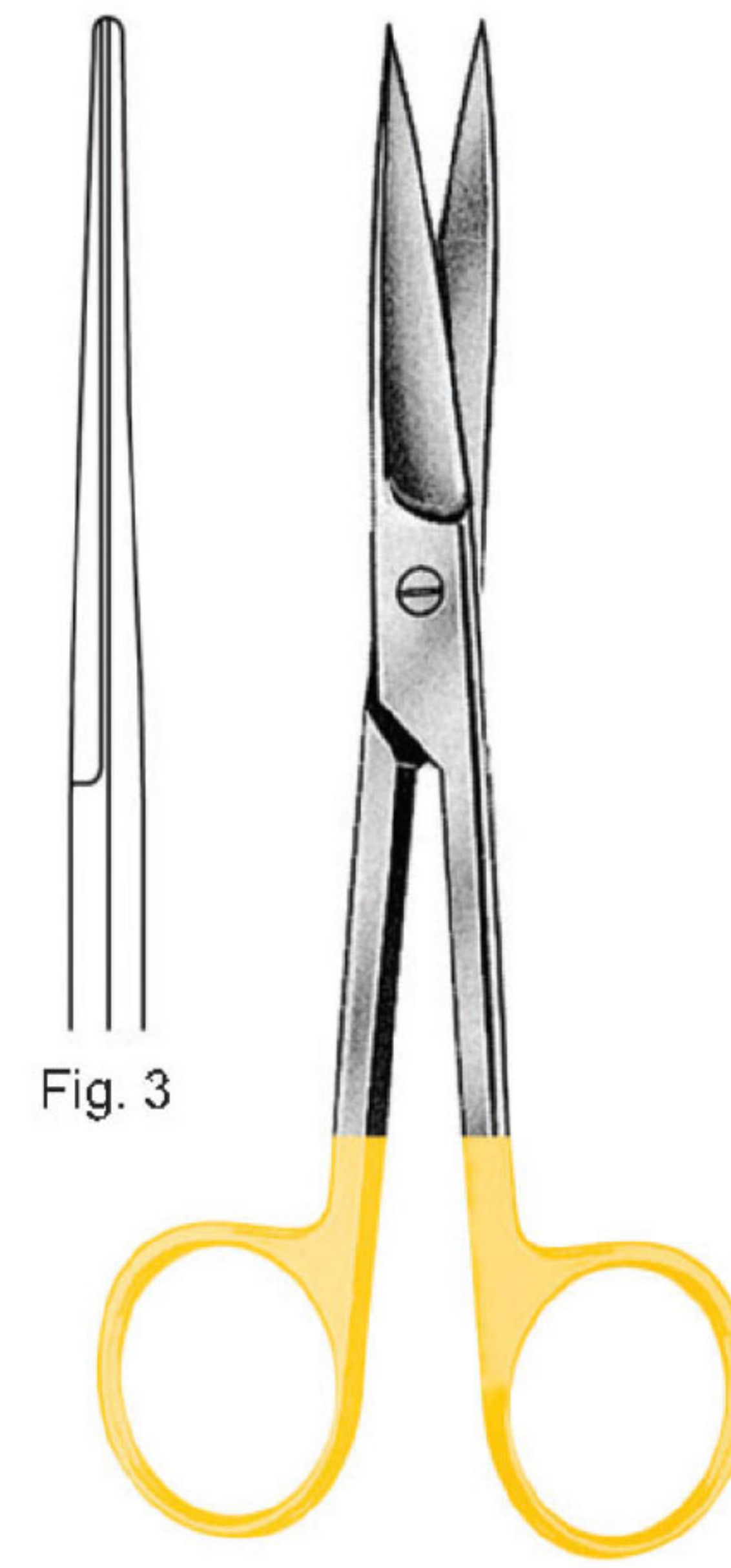

Fig. 3

STANDARD
OI 06-1803-14
14.5 cm/5 ¾"

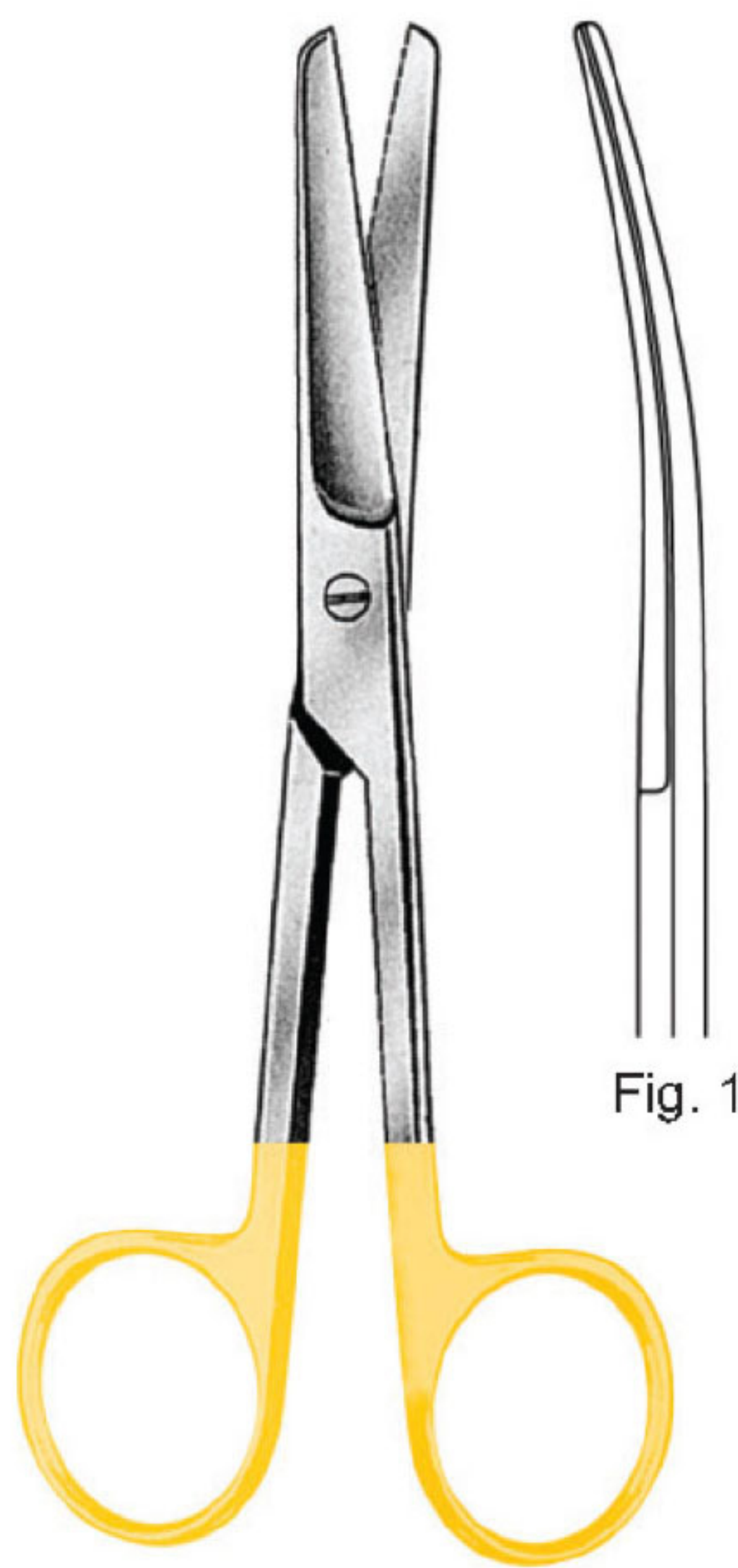

Fig. 1

STANDARD
OI 06-1804-14
14.5 cm/5 ¾"

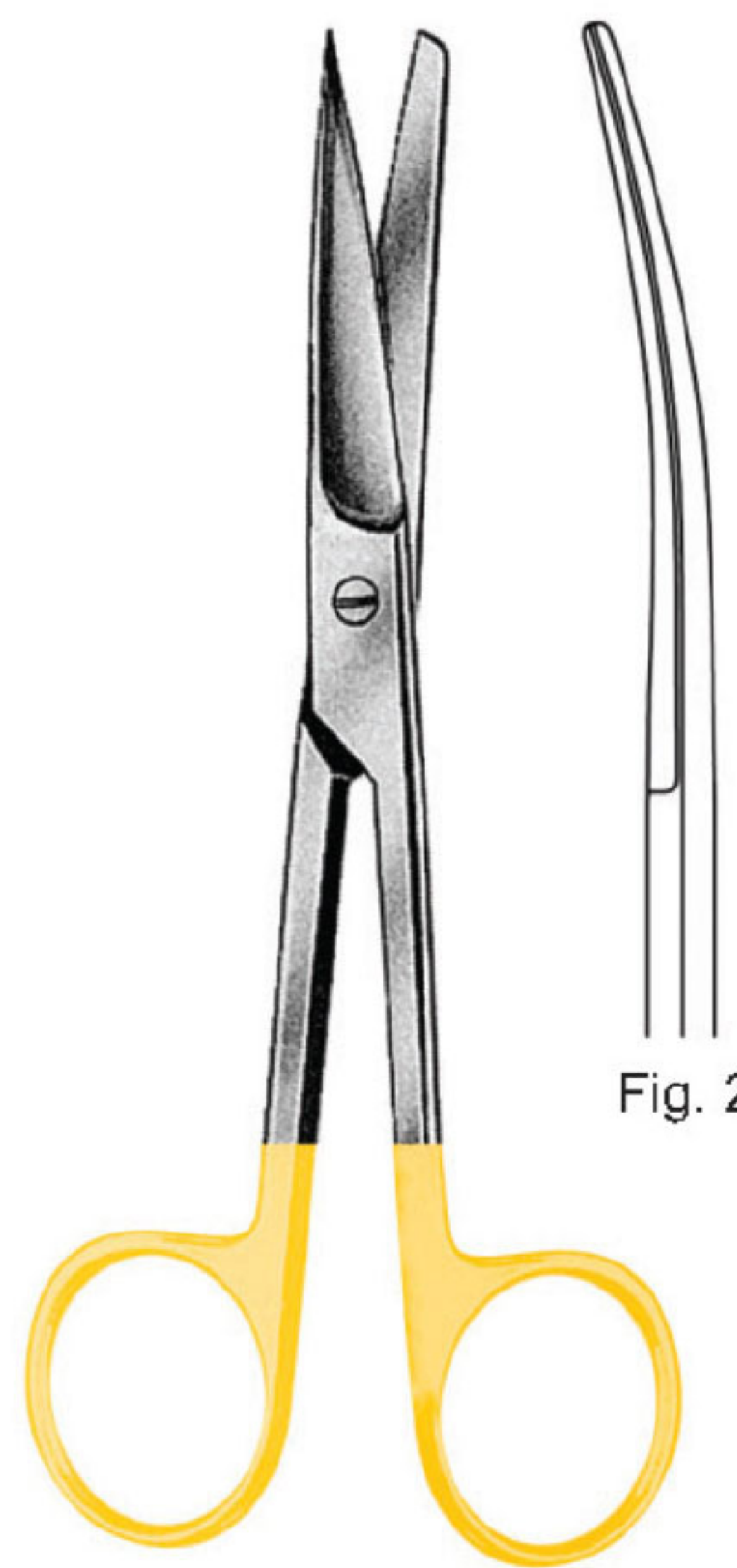

Fig. 2

STANDARD
OI 06-1805-14
14.5 cm/5 ¾"

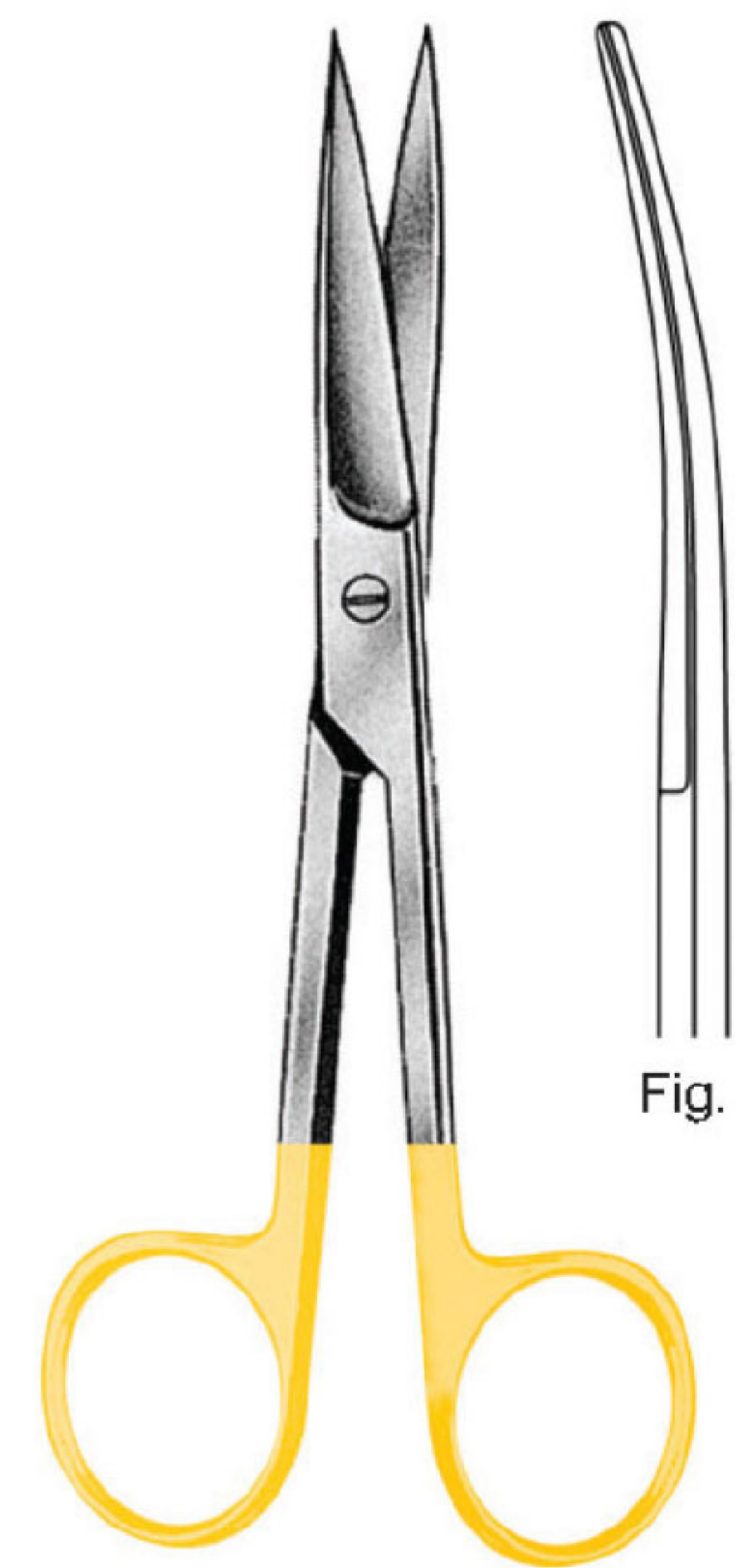
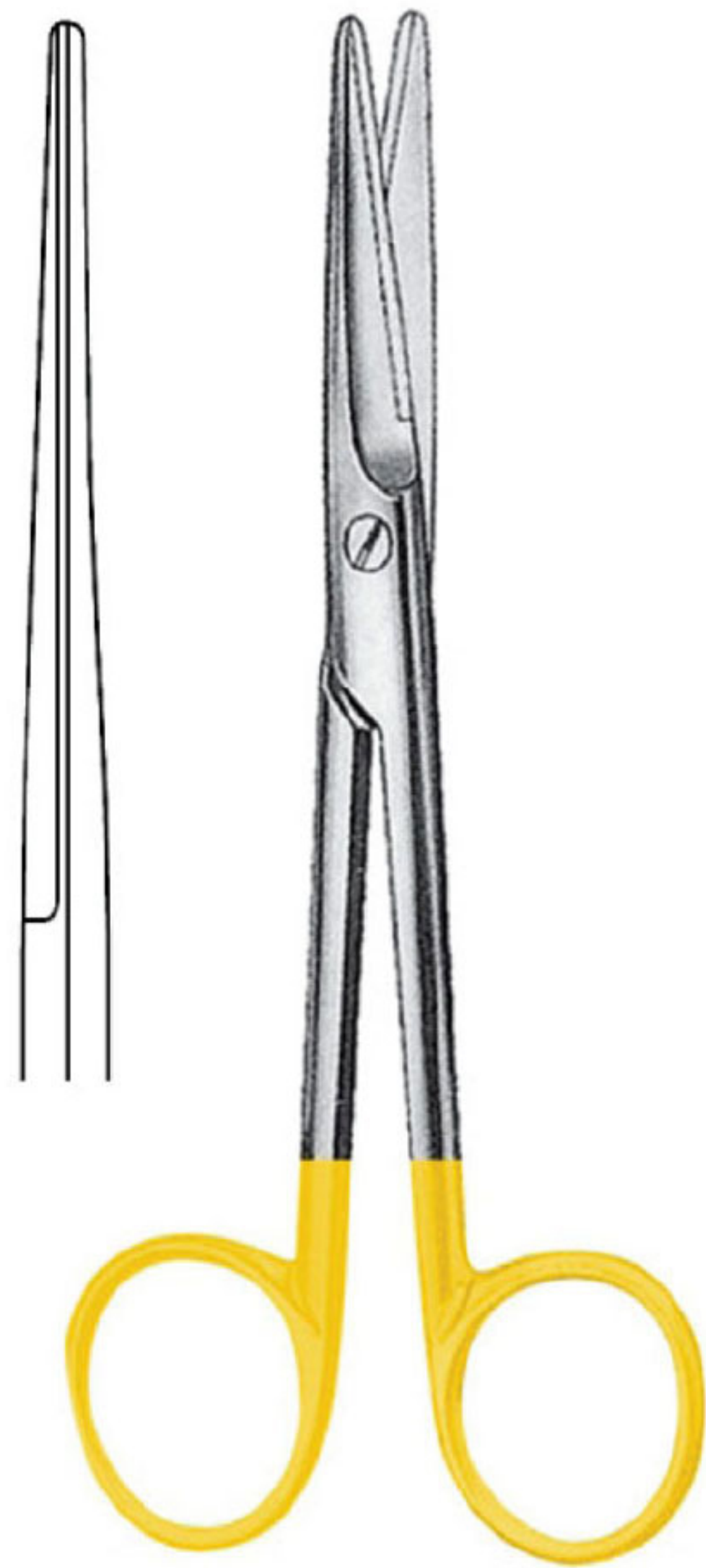
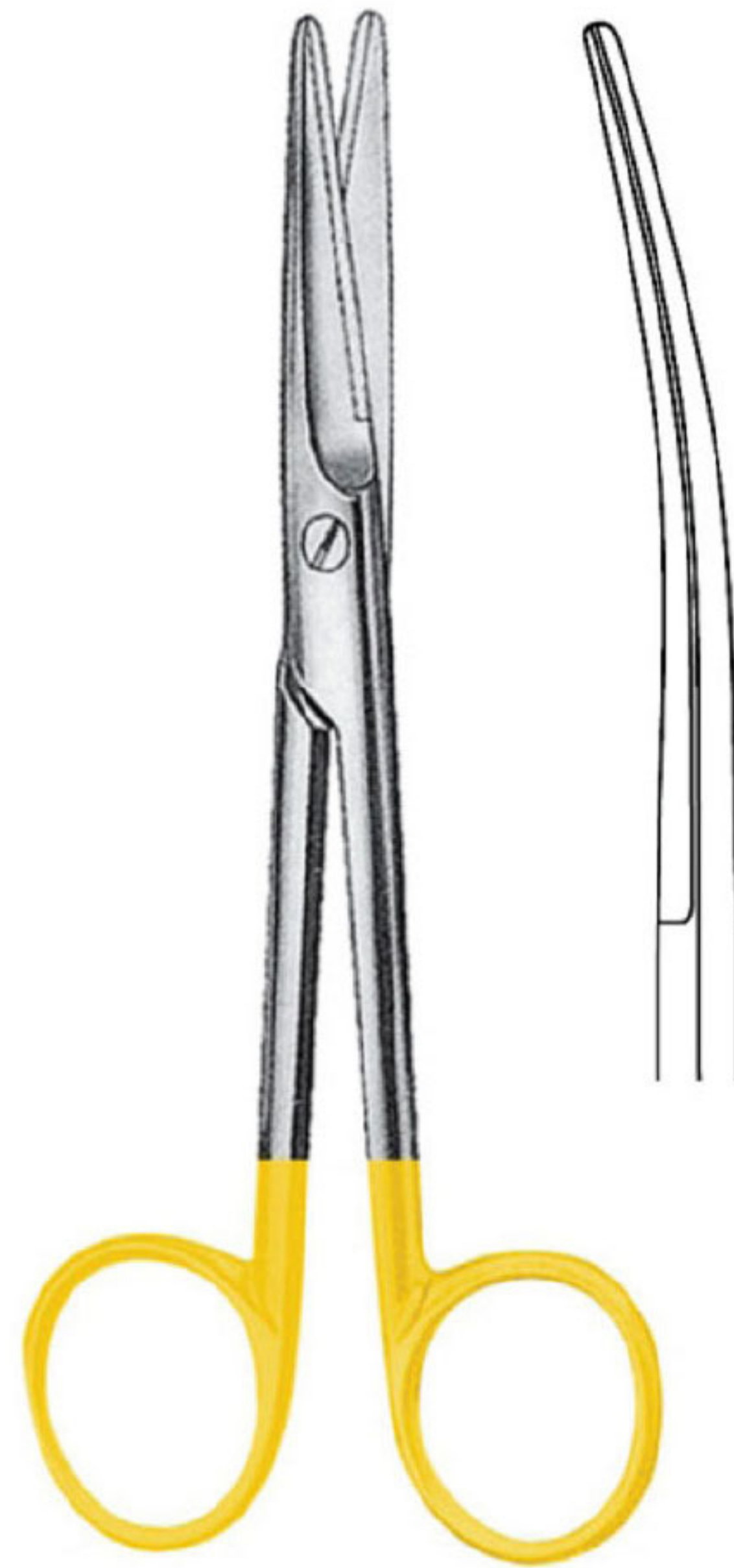

Fig. 3

STANDARD
OI 06-1806-14
14.5 cm/5 ¾"



MAYO-Straight
 OI 06-1807-14 14.5 cm/5 ¾"
 OI 06-1807-17 17 cm/6 ¾"
 OI 06-1807-23 23 cm/9"



MAYO-Curved
 OI 06-1808-14 14.5 cm/5 ¾"
 OI 06-1808-17 17 cm/6 ¾"
 OI 06-1808-23 23 cm/9"



MAYO-LEXER
 Dissecting
 16 cm/6 ¼"

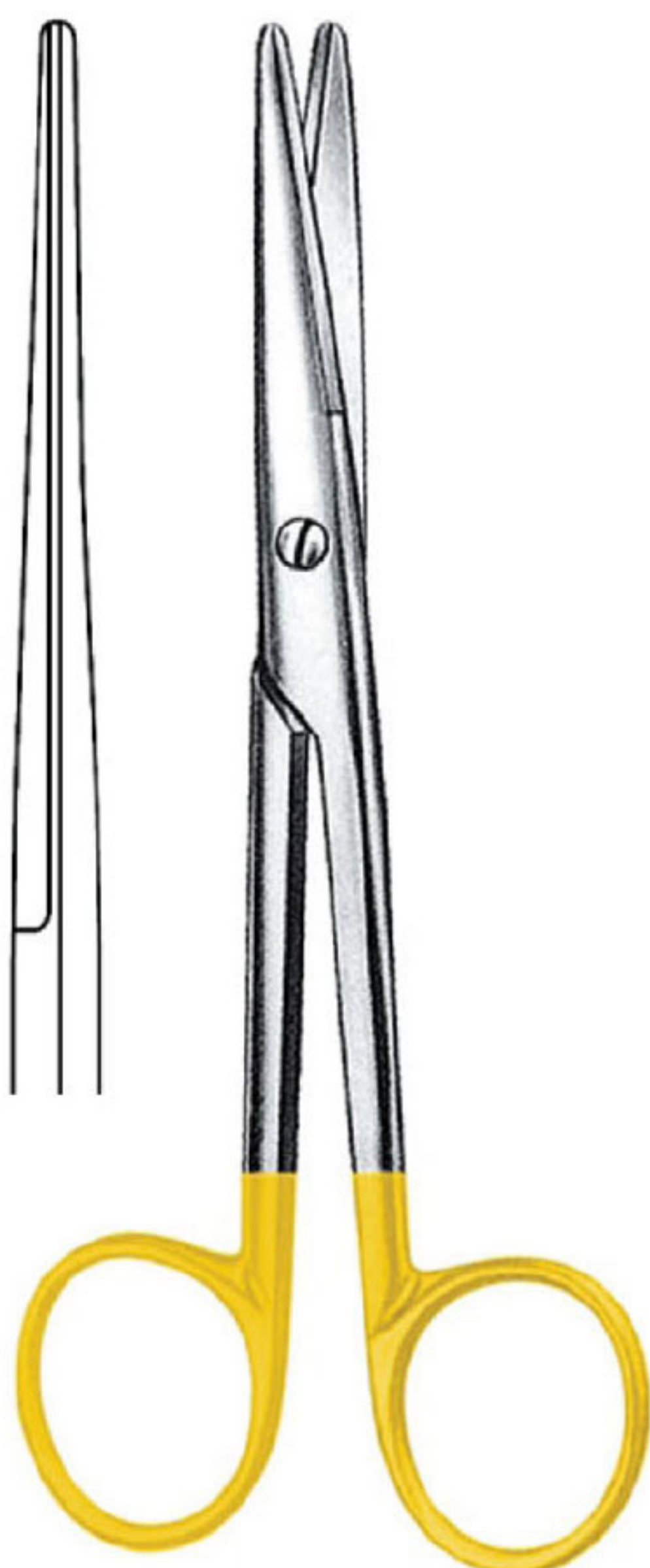

MAYO-STILLE
 OI 06-1811-14 14.5 cm/5 ¾"
 OI 06-1811-17 17 cm/6 ¾"

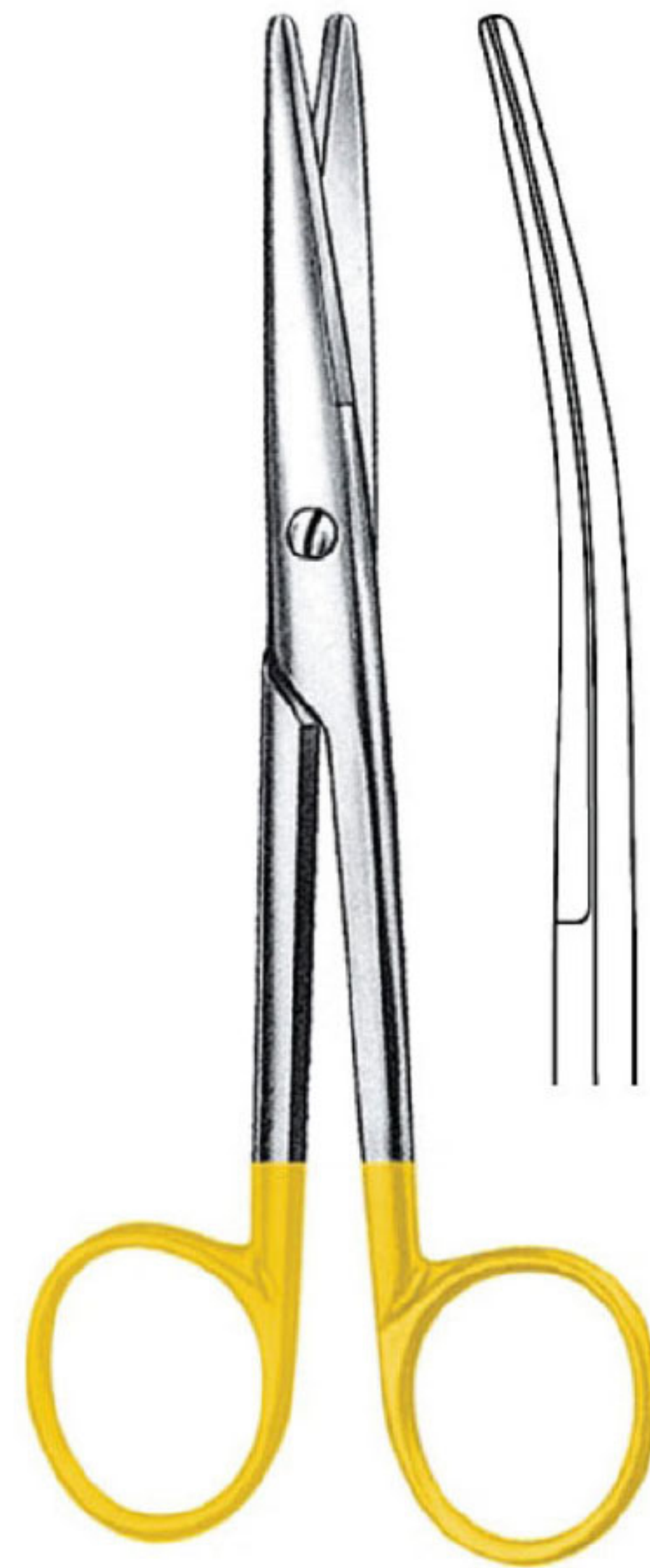

MAYO-STILLE
 OI 06-1812-14 14.5 cm/5 ¾"
 OI 06-1812-17 17 cm/6 ¾"

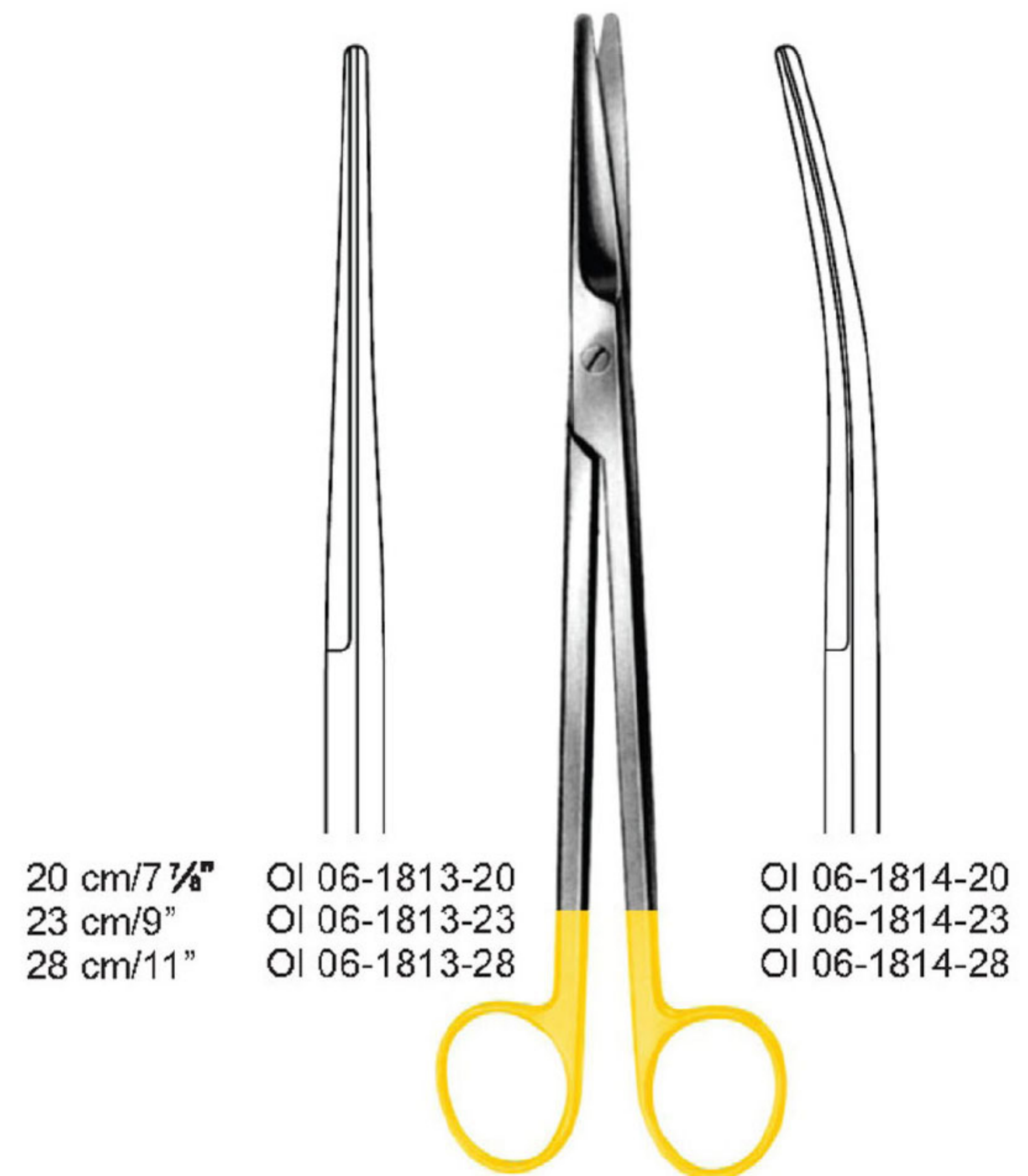

20 cm/7 ⅞"
 23 cm/9"
 28 cm/11"
 OI 06-1813-20
 OI 06-1813-23
 OI 06-1813-28
 OI 06-1814-20
 OI 06-1814-23
 OI 06-1814-28

MAYO-HARRINGTON
 Gynecological



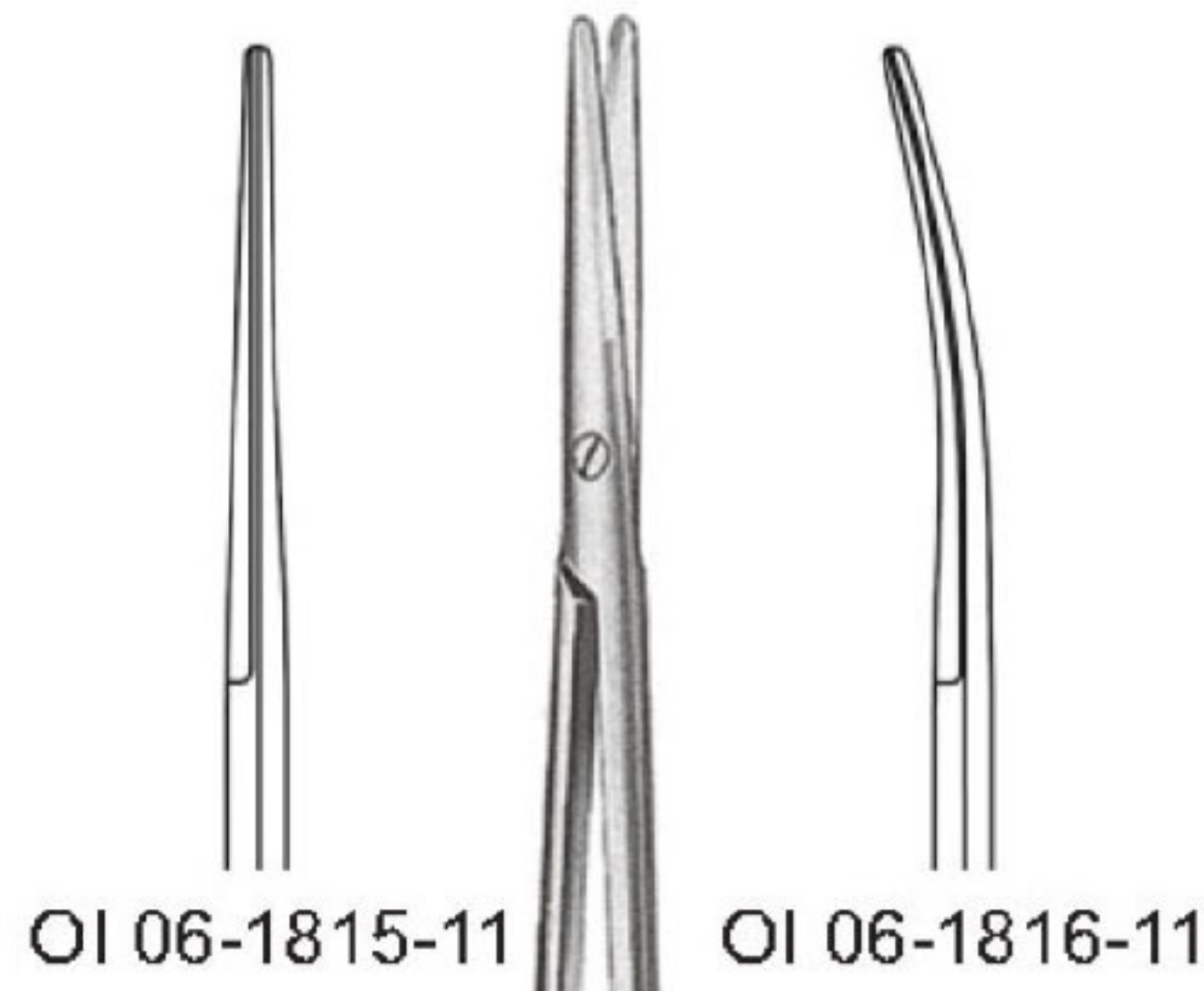

1/2
METZENBAUM
 11.5 cm/4 1/2"

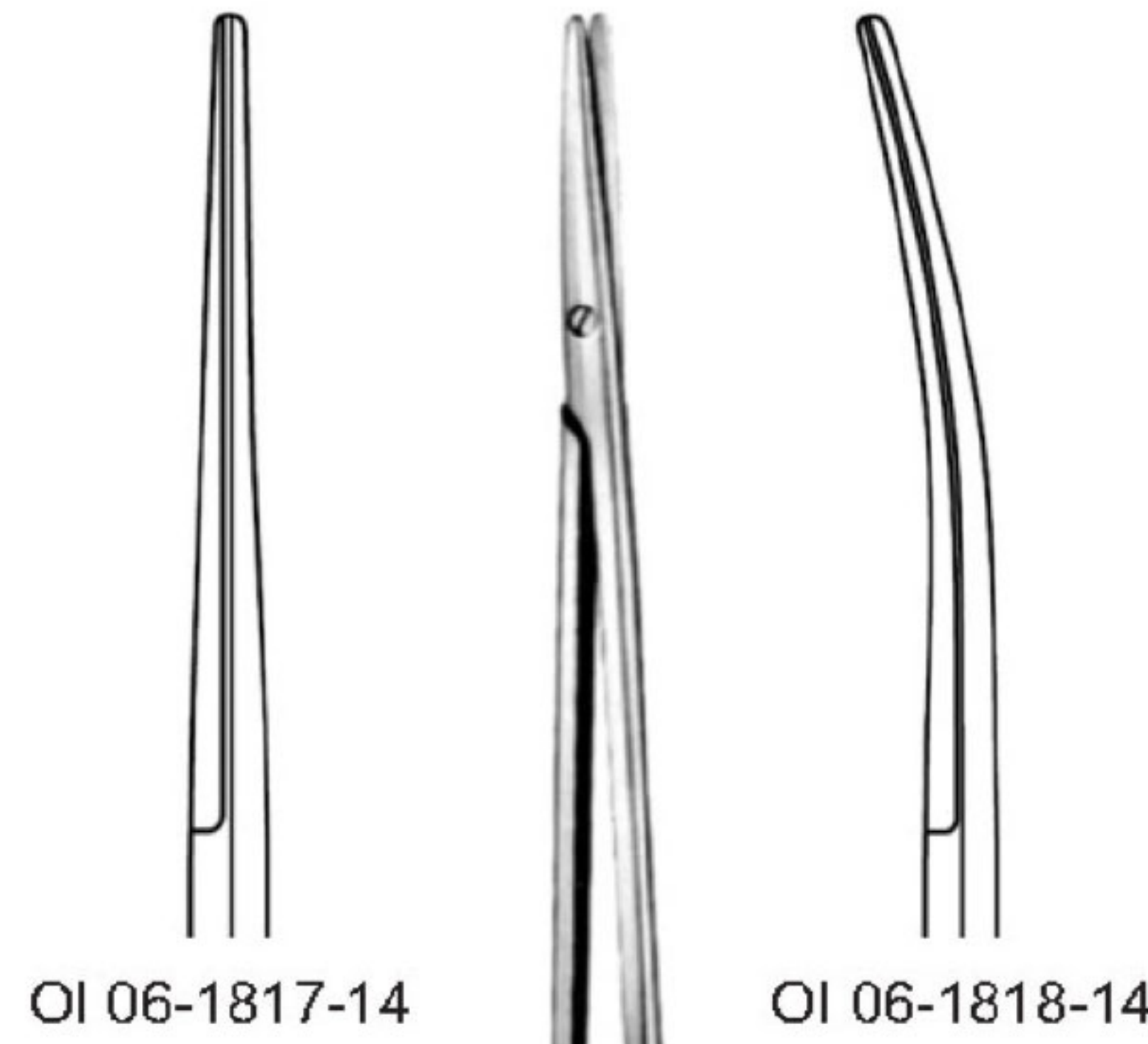

1/2
METZENBAUM
 14.5 cm/5 3/4"

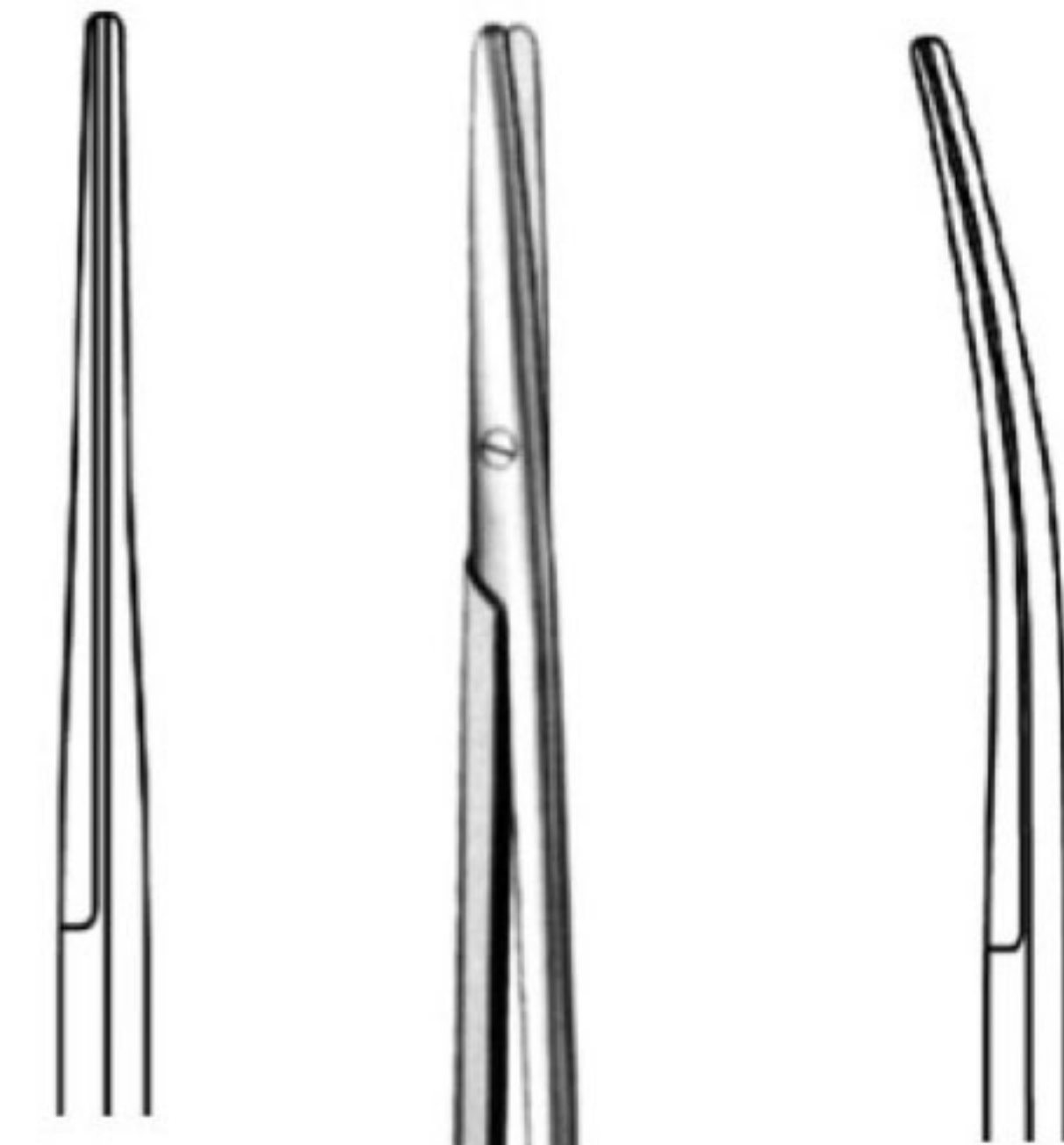

METZENBAUM

Straight		Curved
OI 06-1819-18	18 cm/7 1/8"	OI 06-1820-18
OI 06-1819-20	20 cm/7 7/8"	OI 06-1820-20
OI 06-1819-23	23 cm/9"	OI 06-1820-23
OI 06-1819-25	25 cm/9 7/8"	OI 06-1820-25
OI 06-1819-28	28 cm/11"	OI 06-1820-28
OI 06-1819-30	30 cm/11 3/4"	OI 06-1820-30

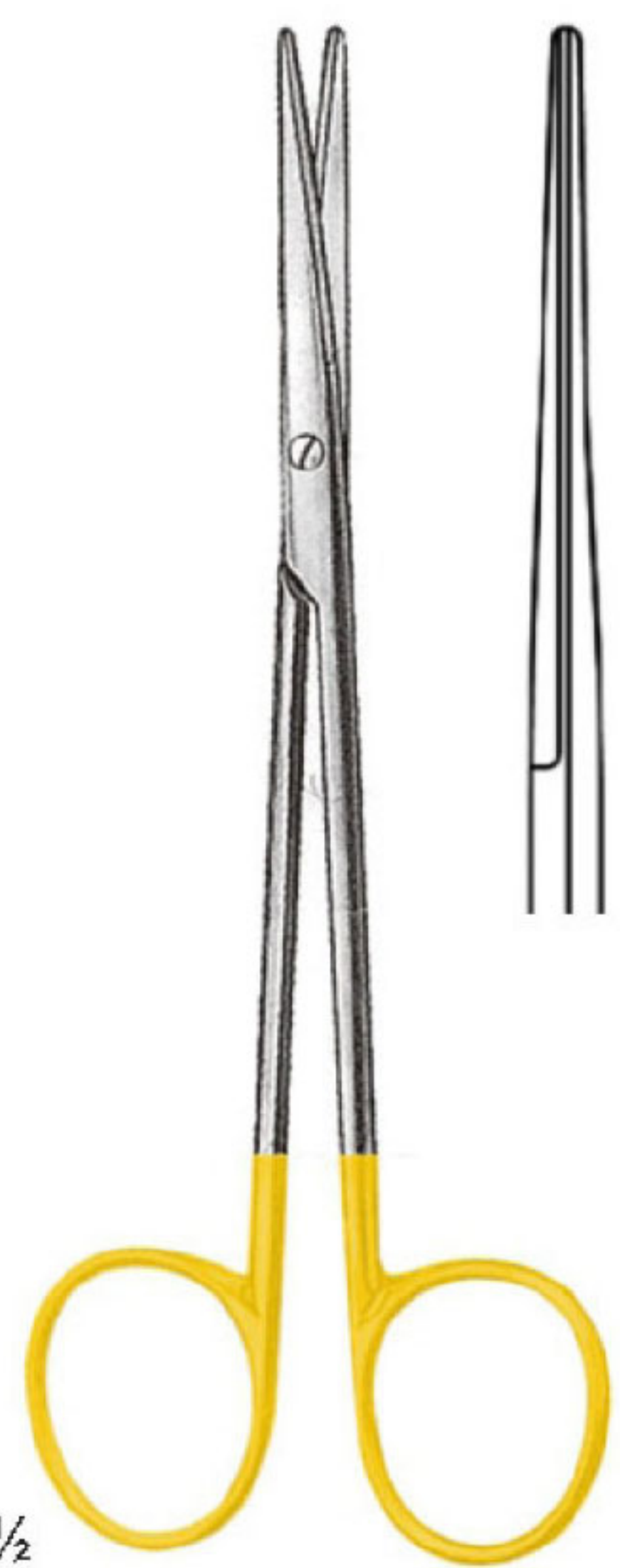

1/2
METZENBAUM-Fino
 OI 06-1821-14
 14.5 cm/5 3/4"

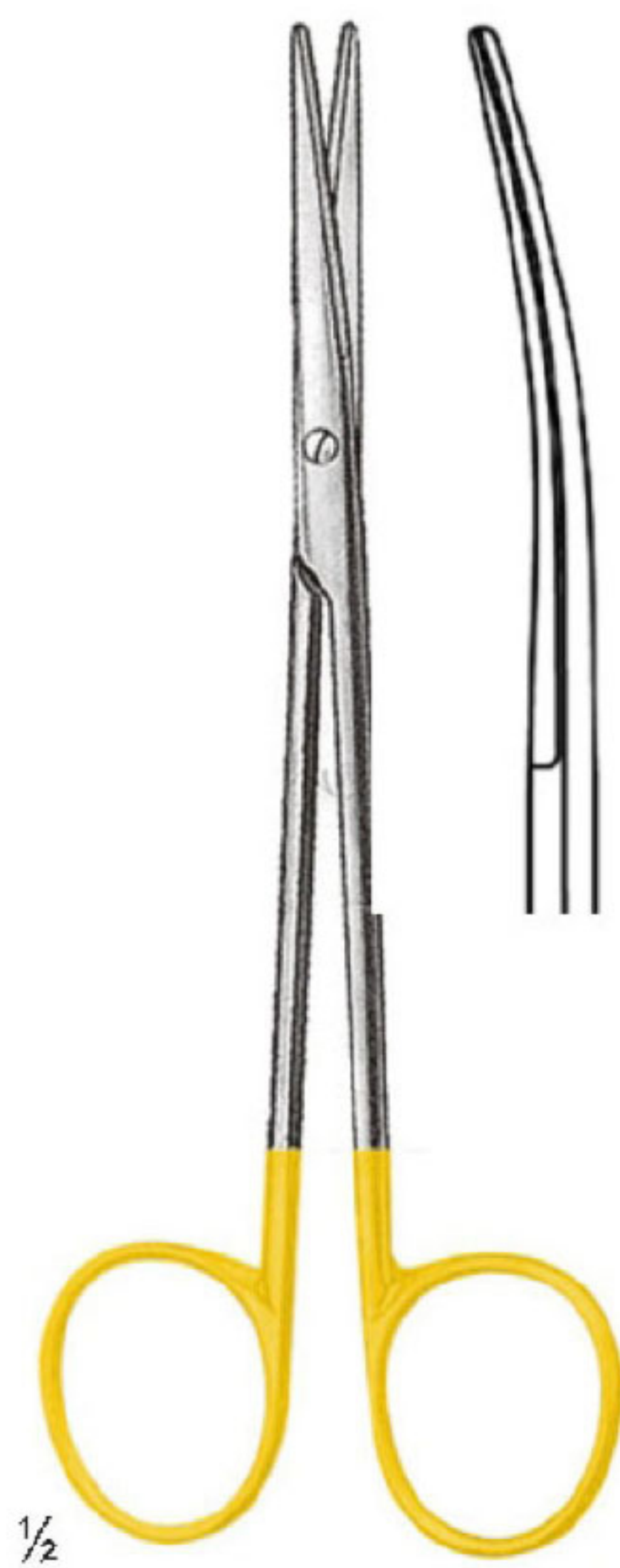

1/2
METZENBAUM-Fino
 OI 06-1822-14
 14.5 cm/5 3/4"



1/2
METZENBAUM-Fino
 OI 06-1823-14
 14.5 cm/5 3/4"

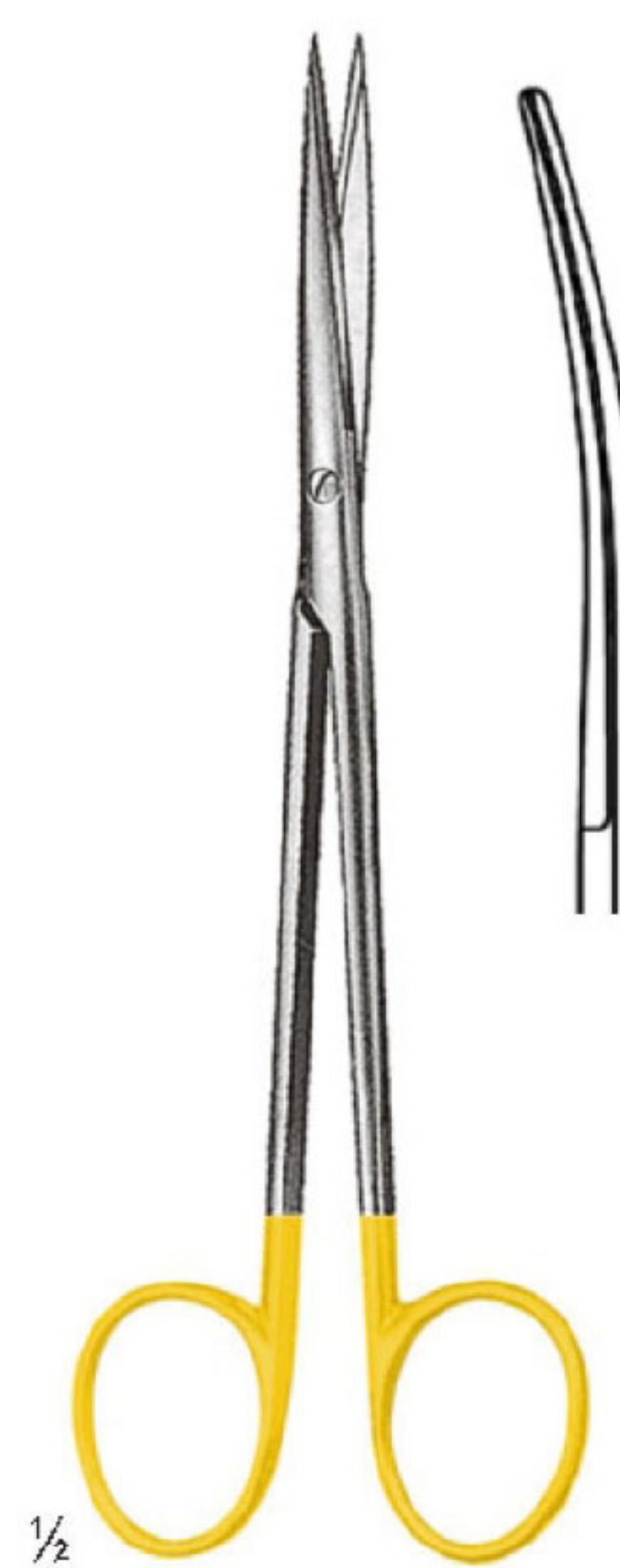

1/2
METZENBAUM-Fino
 OI 06-1824-14
 14.5 cm/5 3/4"



TC SCISSORS

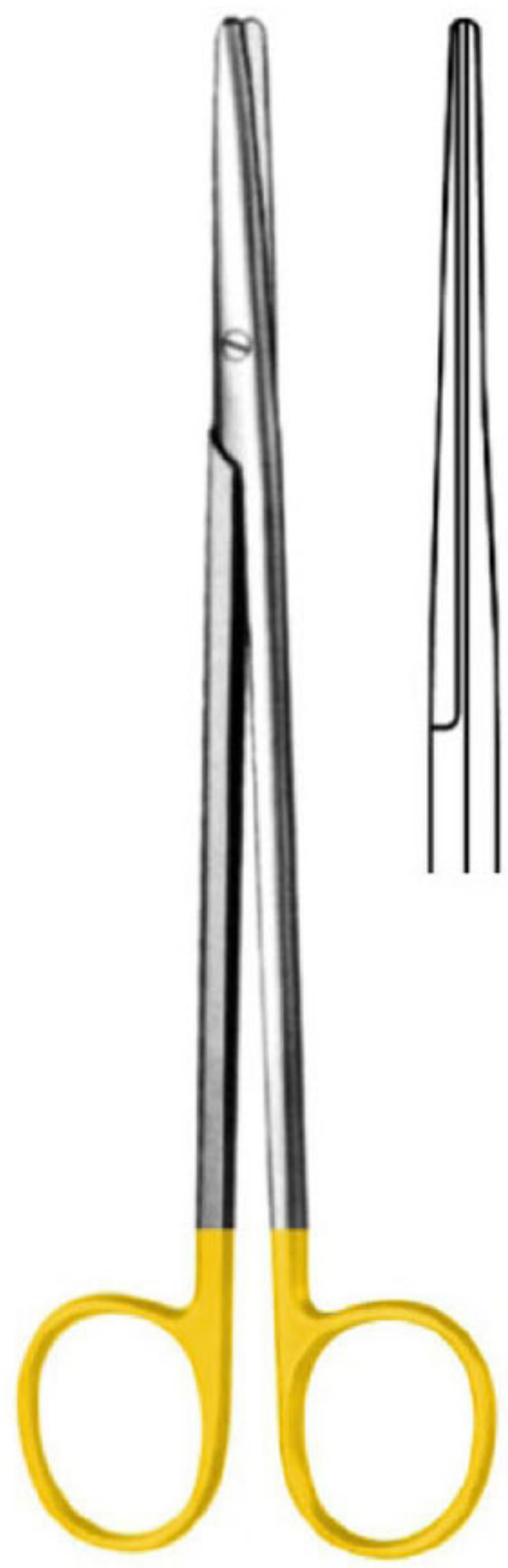

METZENBAUM-Fino
 OI 06-1825-18 18 cm/7¹/₈"
 OI 06-1825-20 20 cm/7⁷/₈"
 OI 06-1825-23 23 cm/9"
 OI 06-1825-25 25 cm/9³/₈"
 OI 06-1825-28 28 cm/11"

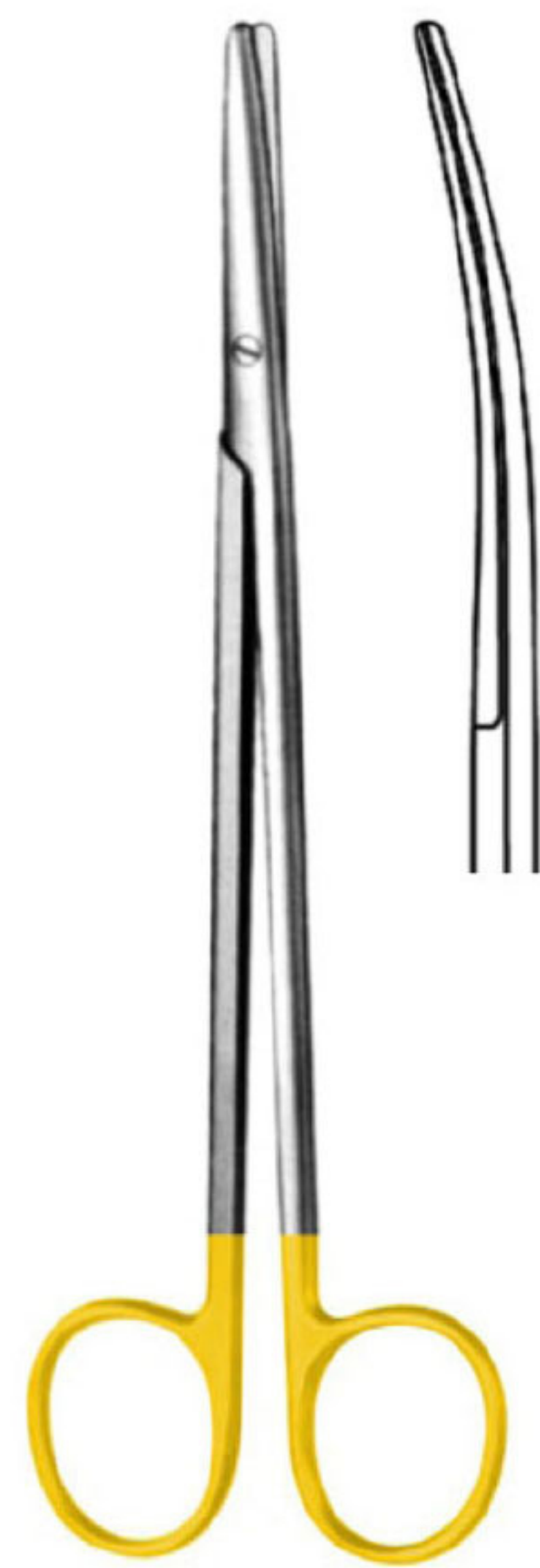

METZENBAUM-Fino
 OI 06-1826-18 18 cm/7¹/₈"
 OI 06-1826-20 20 cm/7⁷/₈"
 OI 06-1826-23 23 cm/9"
 OI 06-1826-25 25 cm/9³/₈"
 OI 06-1826-28 28 cm/11"

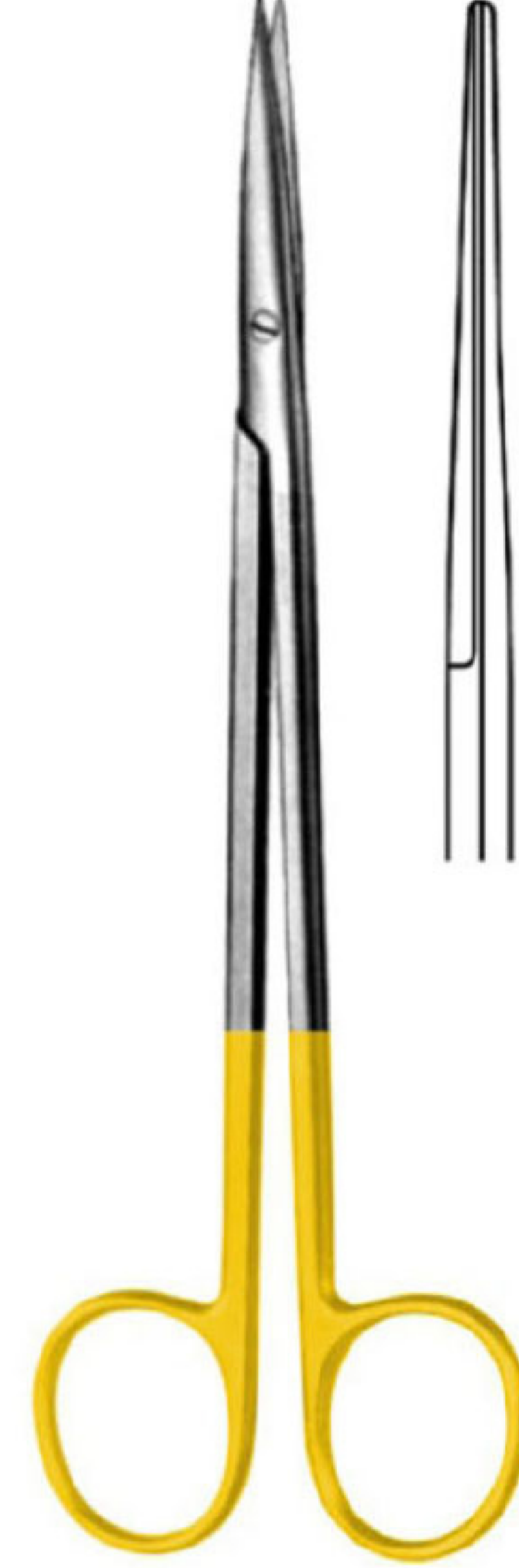

METZENBAUM-Fino
 OI 06-1827-18 18 cm/7¹/₈"
 OI 06-1827-20 20 cm/7⁷/₈"
 OI 06-1827-23 23 cm/9"
 OI 06-1827-25 25 cm/9³/₈"
 OI 06-1827-28 28 cm/11"

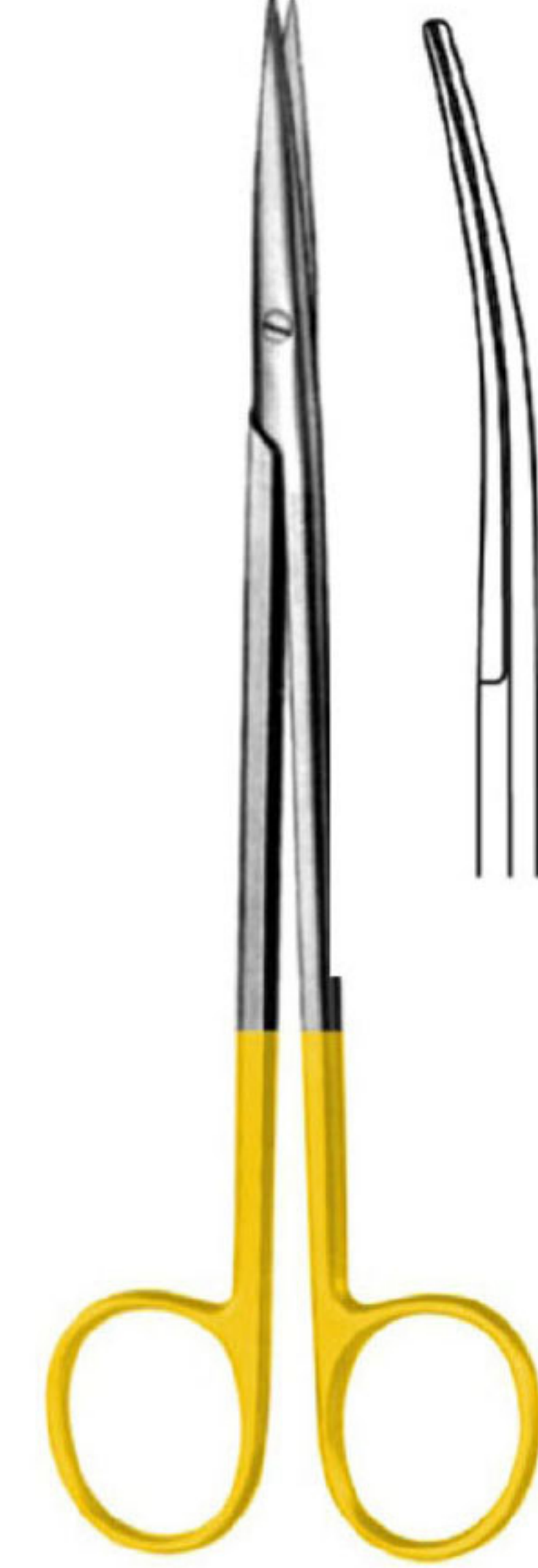

METZENBAUM-Fino
 OI 06-1828-18 18 cm/7¹/₈"
 OI 06-1828-20 20 cm/7⁷/₈"
 OI 06-1828-23 23 cm/9"
 OI 06-1828-25 25 cm/9³/₈"
 OI 06-1828-28 28 cm/11"

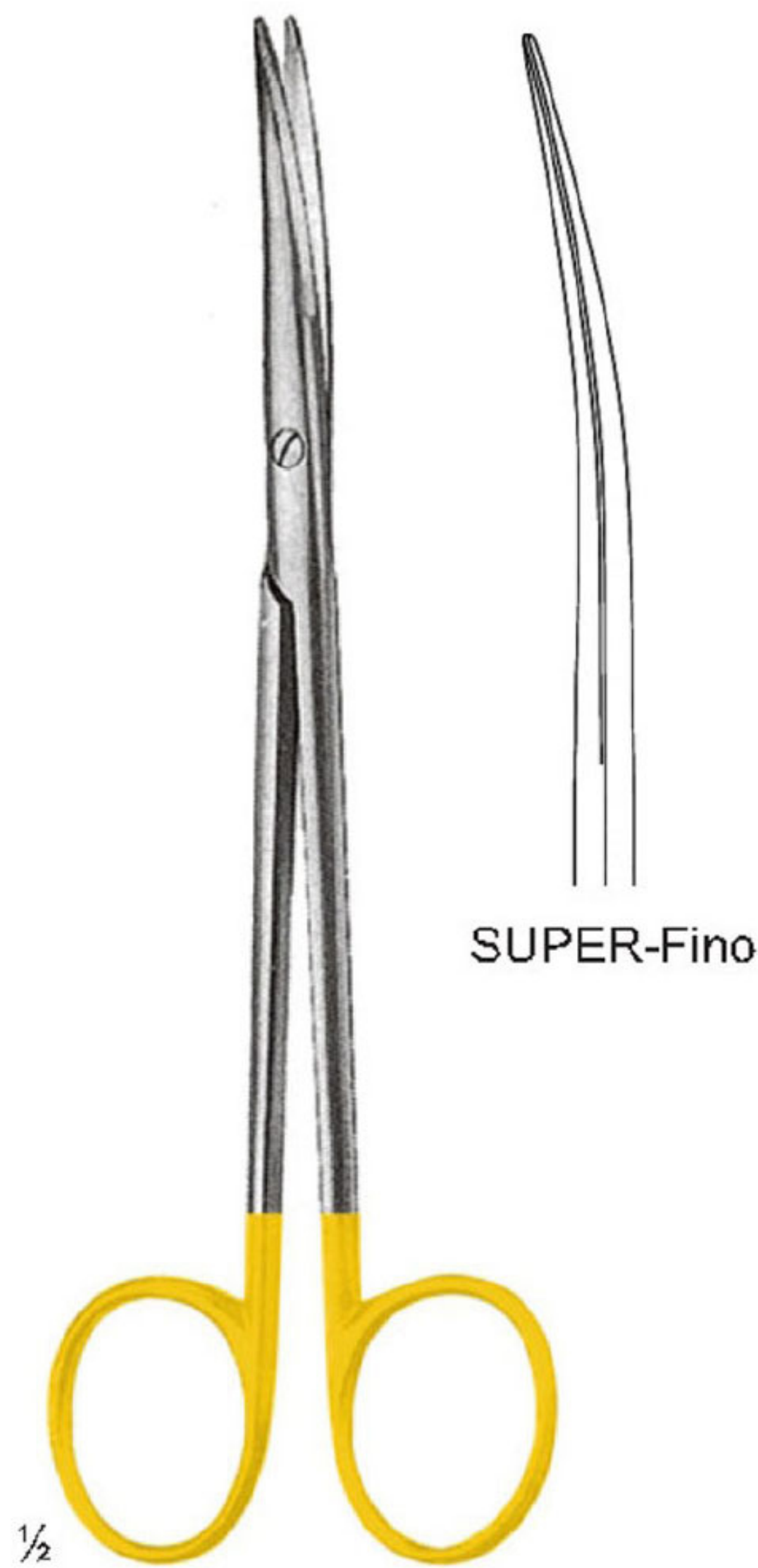

TOENNIS-ADSON
 OI 06-1829-17
 17.5 cm/6⁷/₈"

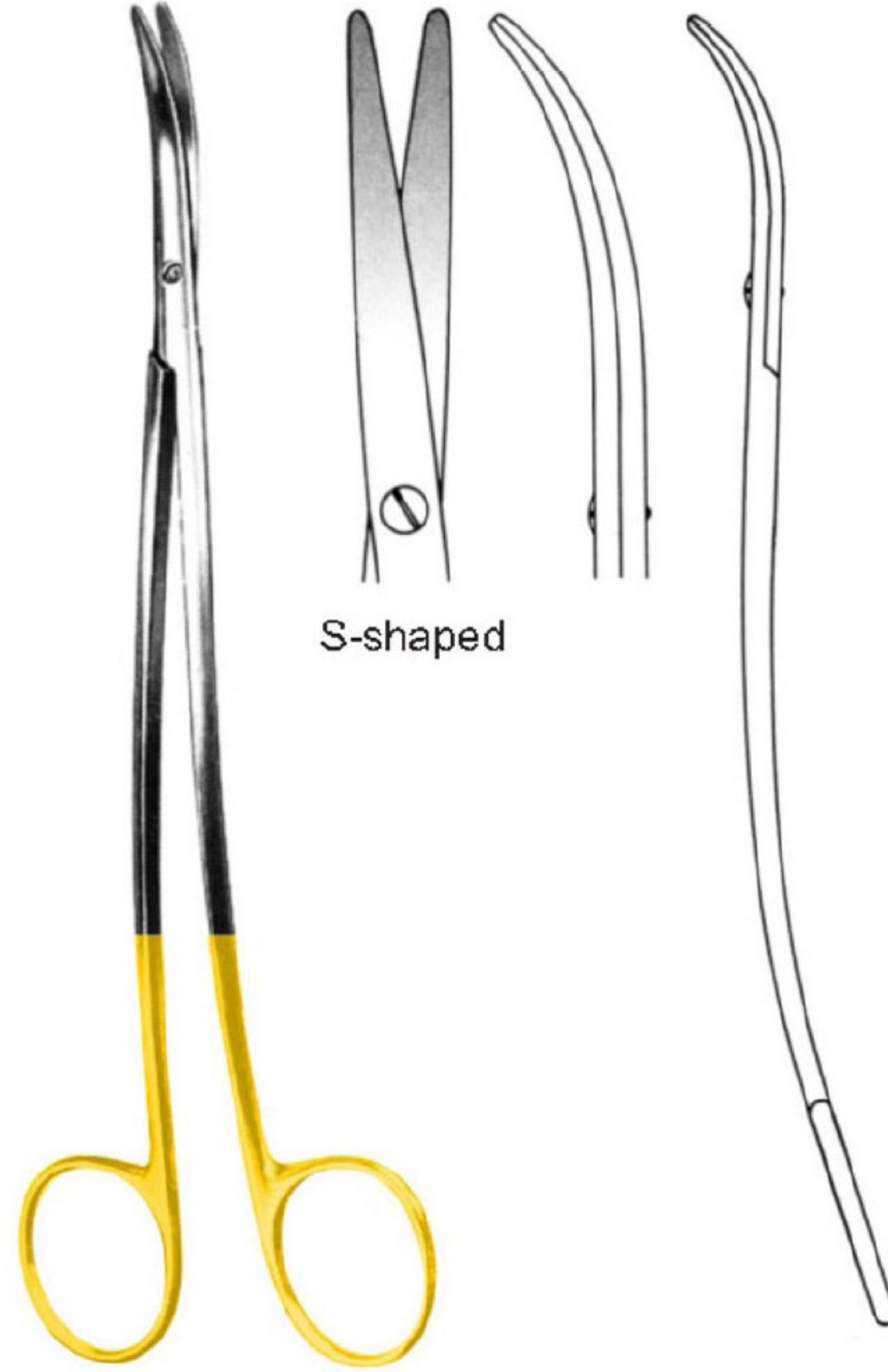

METZENBAUM-Fino
 OI 06-1830-18 18 cm/7¹/₈"
 OI 06-1830-20 20 cm/7⁷/₈"
 OI 06-1830-23 23 cm/9"

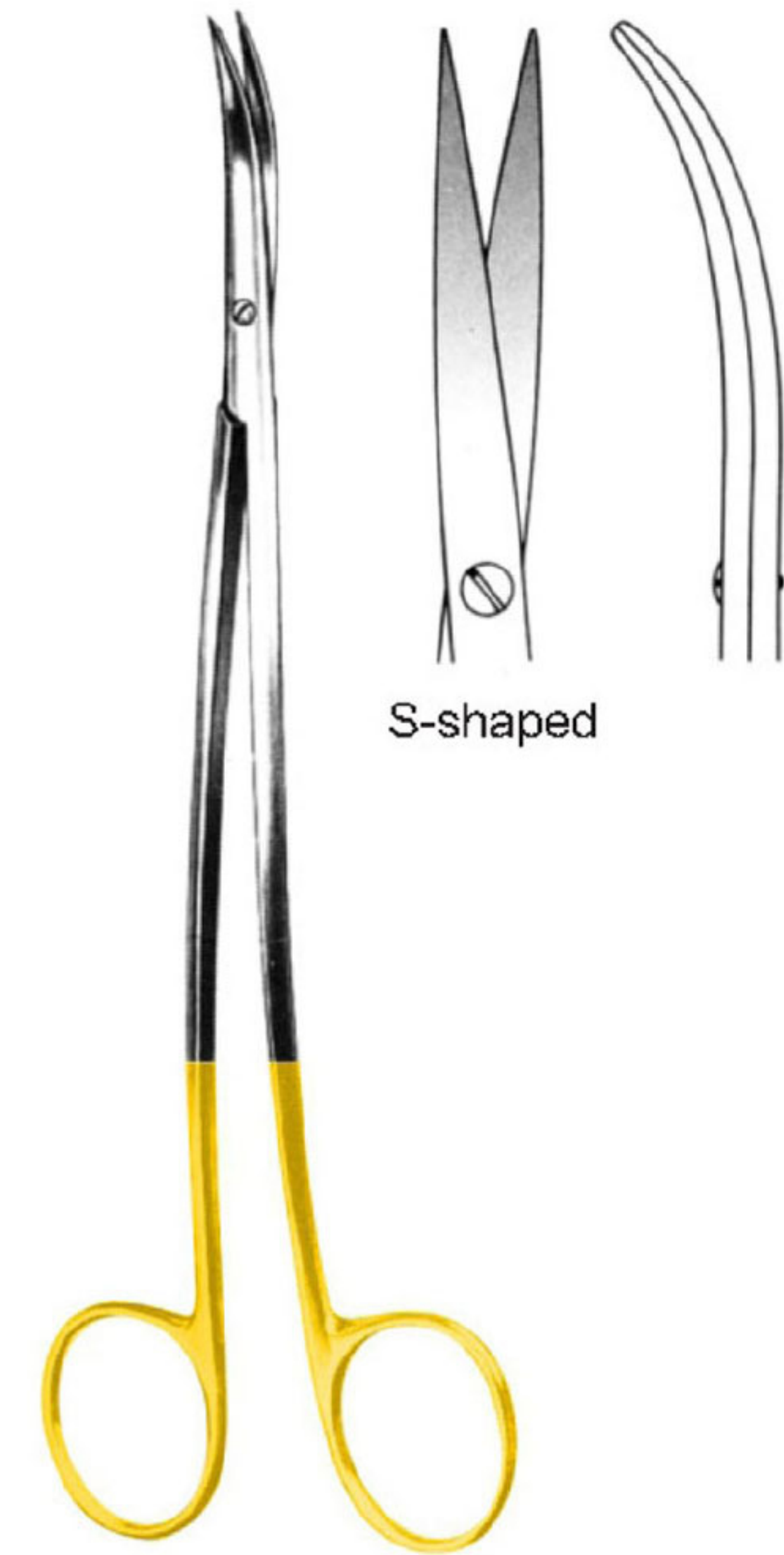

METZENBAUM-Fino
 OI 06-1831-18 18 cm/7¹/₈"
 OI 06-1831-20 20 cm/7⁷/₈"
 OI 06-1831-23 23 cm/9"



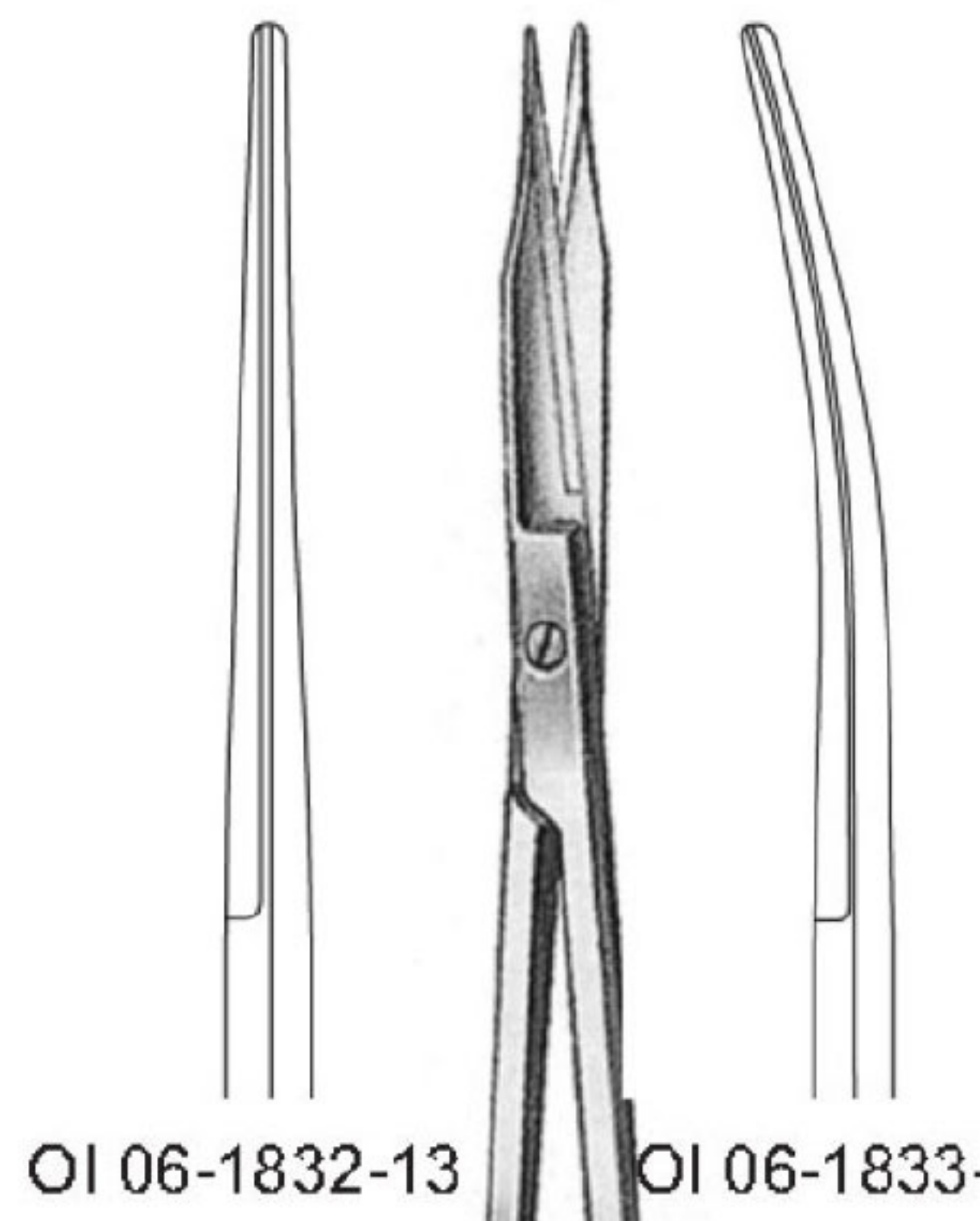

GOLDMAN-FOX
13 cm/5 1/8"

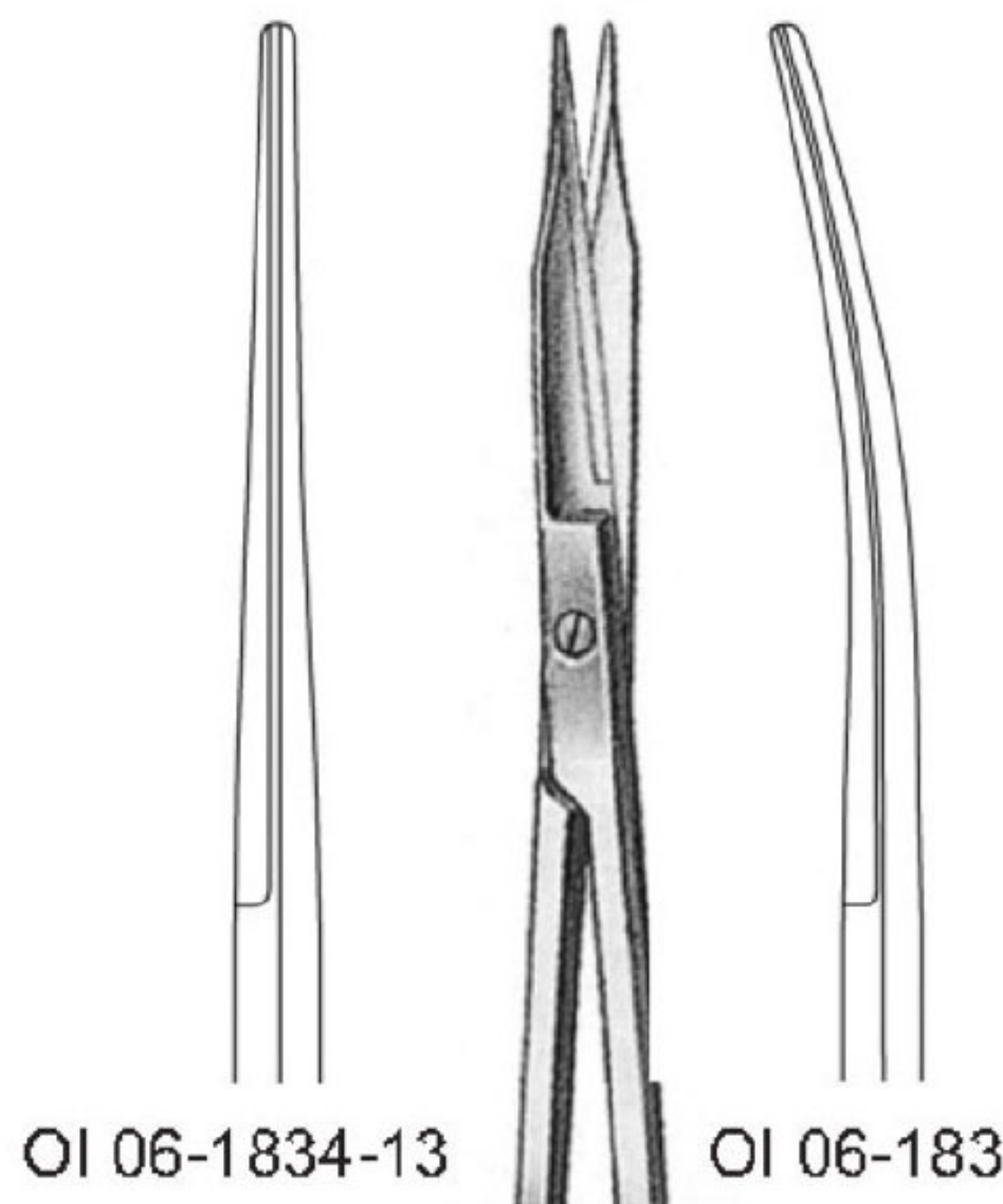

GOLDMAN-FOX
Toothed blades
13 cm/5 1/8"

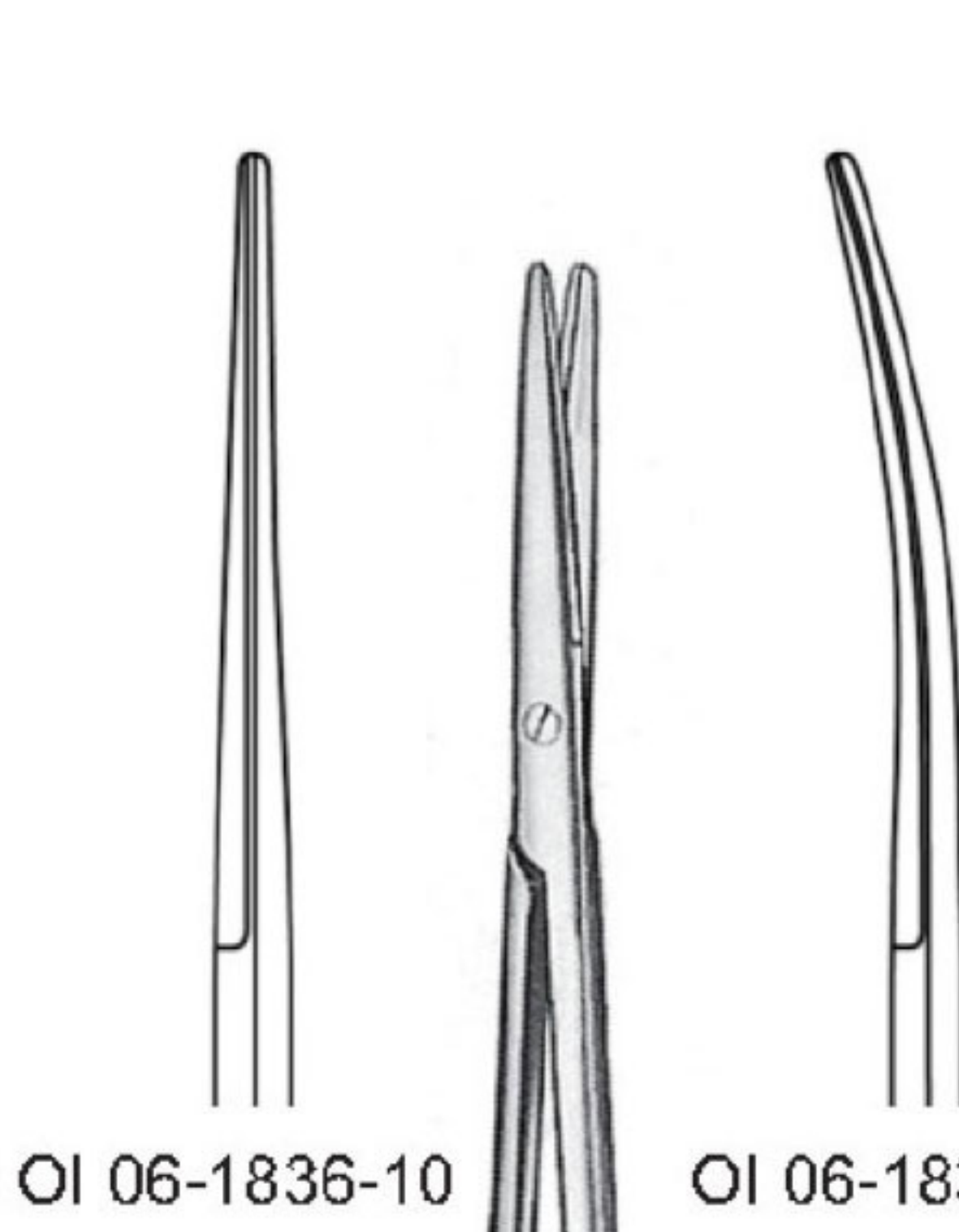

KNAPP/LEXER-Baby
Starbismus
10 cm/3 7/8"

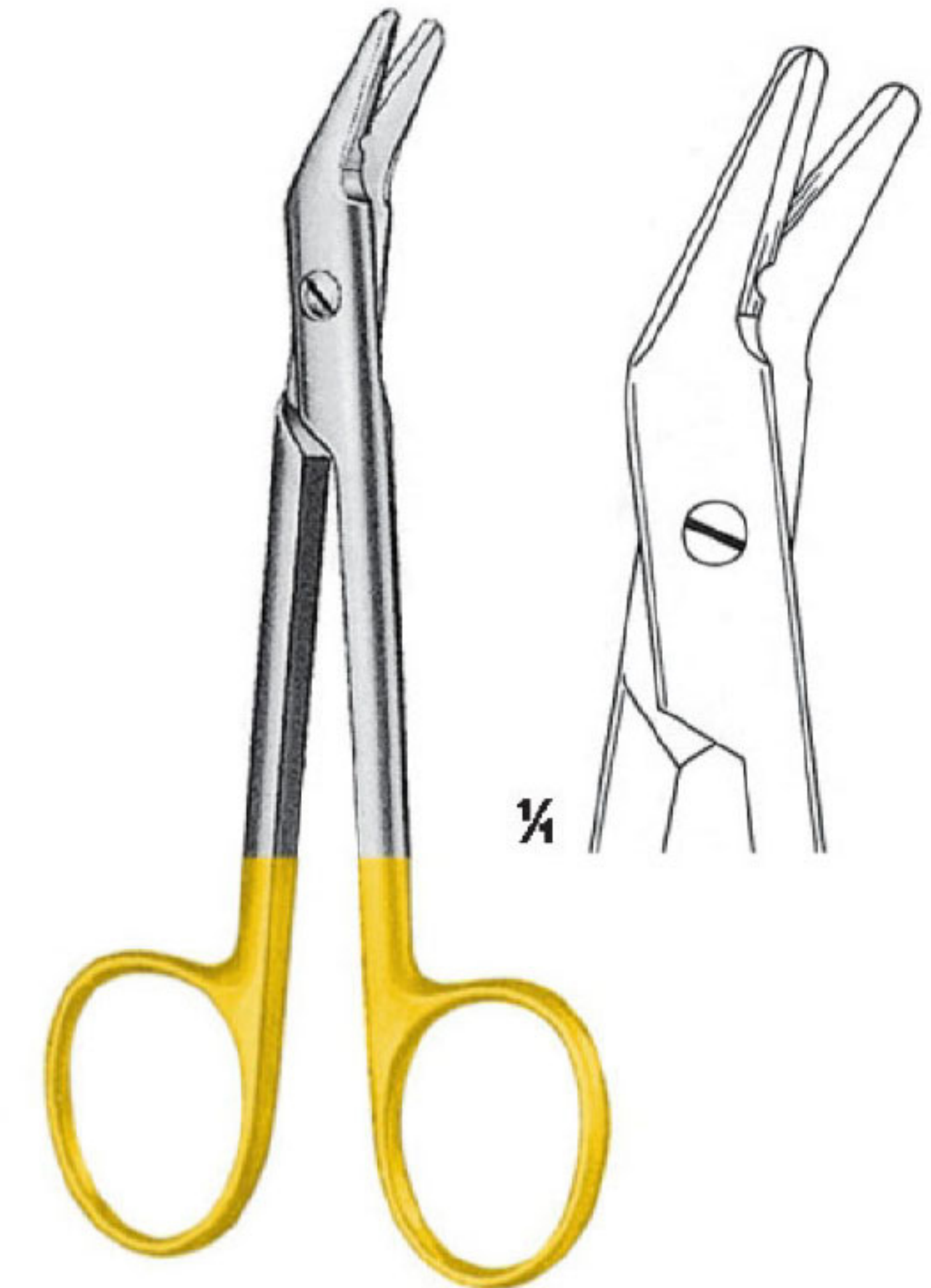

UNIVERSAL (Wire Cutting)
OI 06-1838-12
12 cm/4 3/4"



IRIS
11.5 cm/4 1/2"



BEEBEE

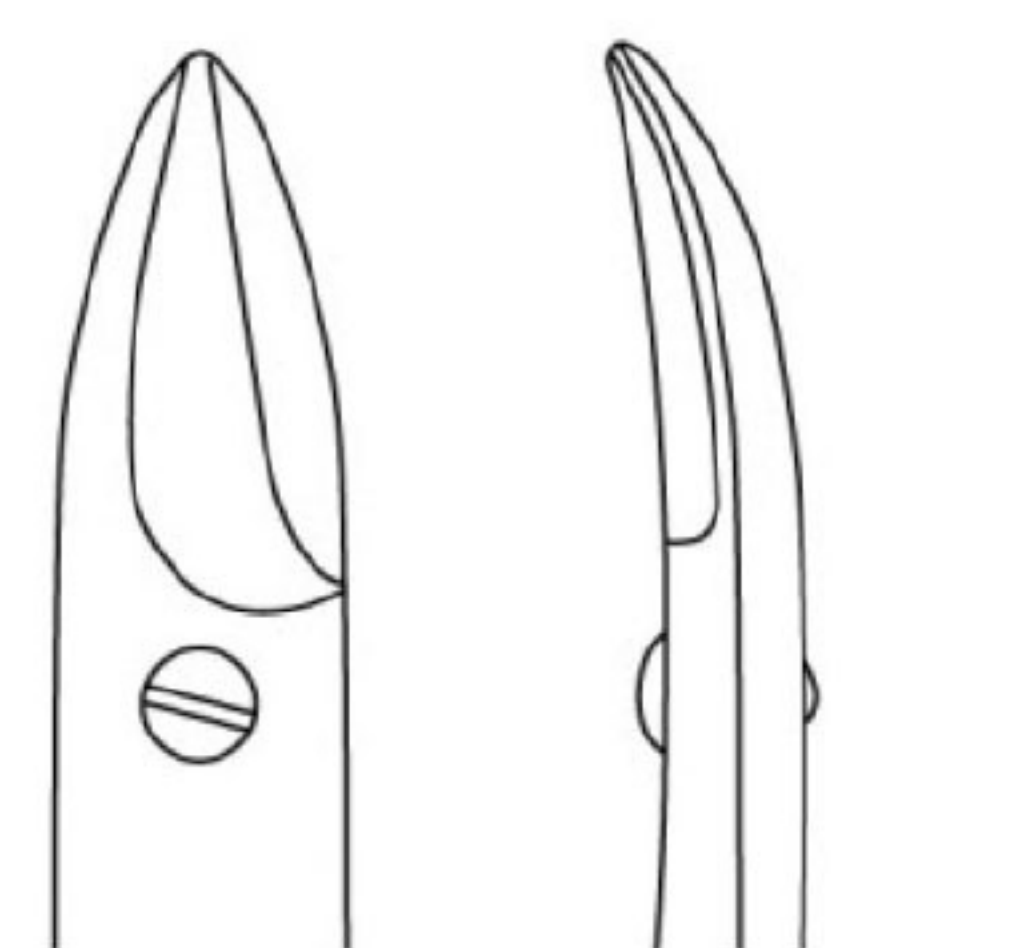

OI 06-1842-11
11 cm/4 1/2"
Sharp

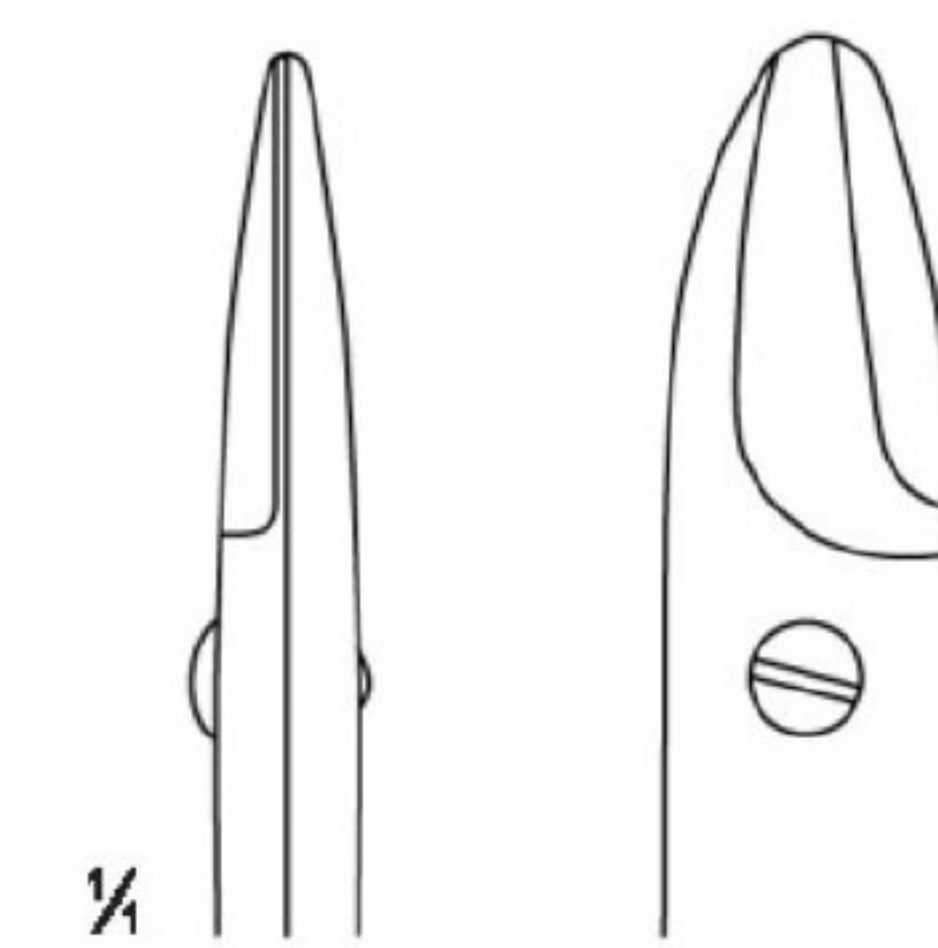

OI 06-1843-10
10 cm/3 7/8"
Blunt

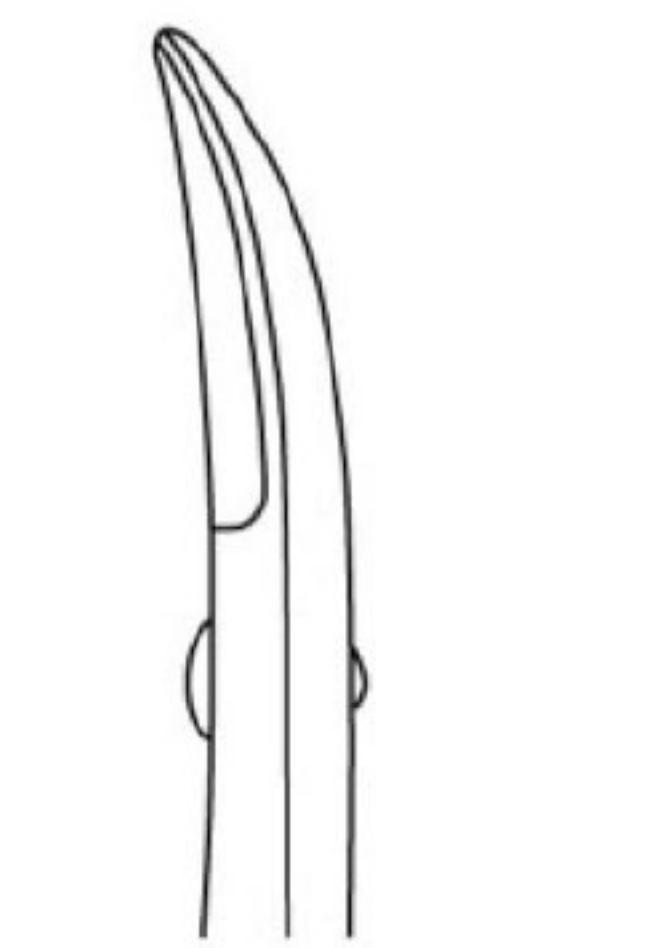

OI 06-1844-10
10 cm/3 7/8"
Blunt

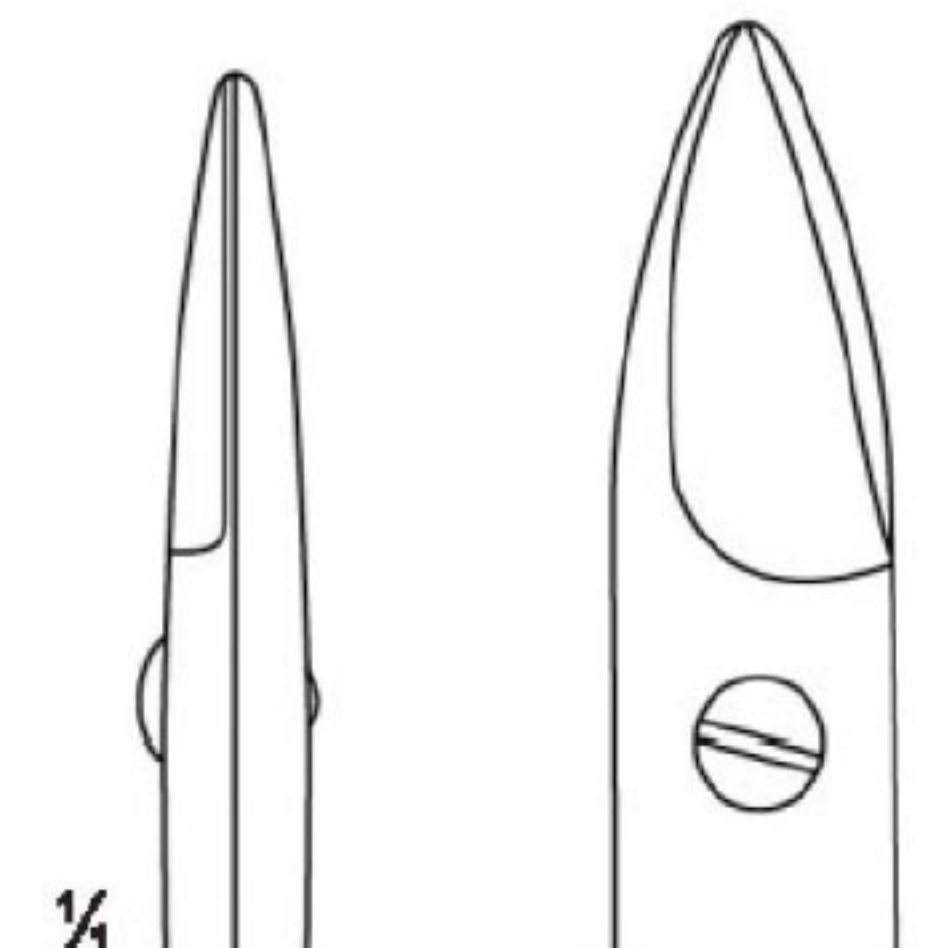

OI 06-1845-11
11 cm/4 3/8"
Sharp

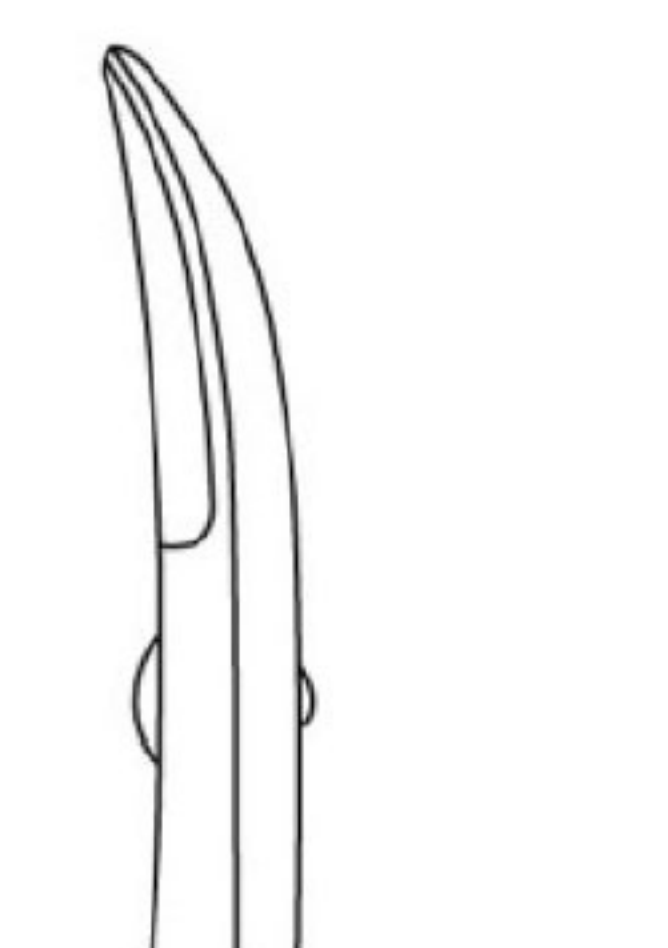

OI 06-1846-11
11 cm/4 3/8"
1 Blade serrated

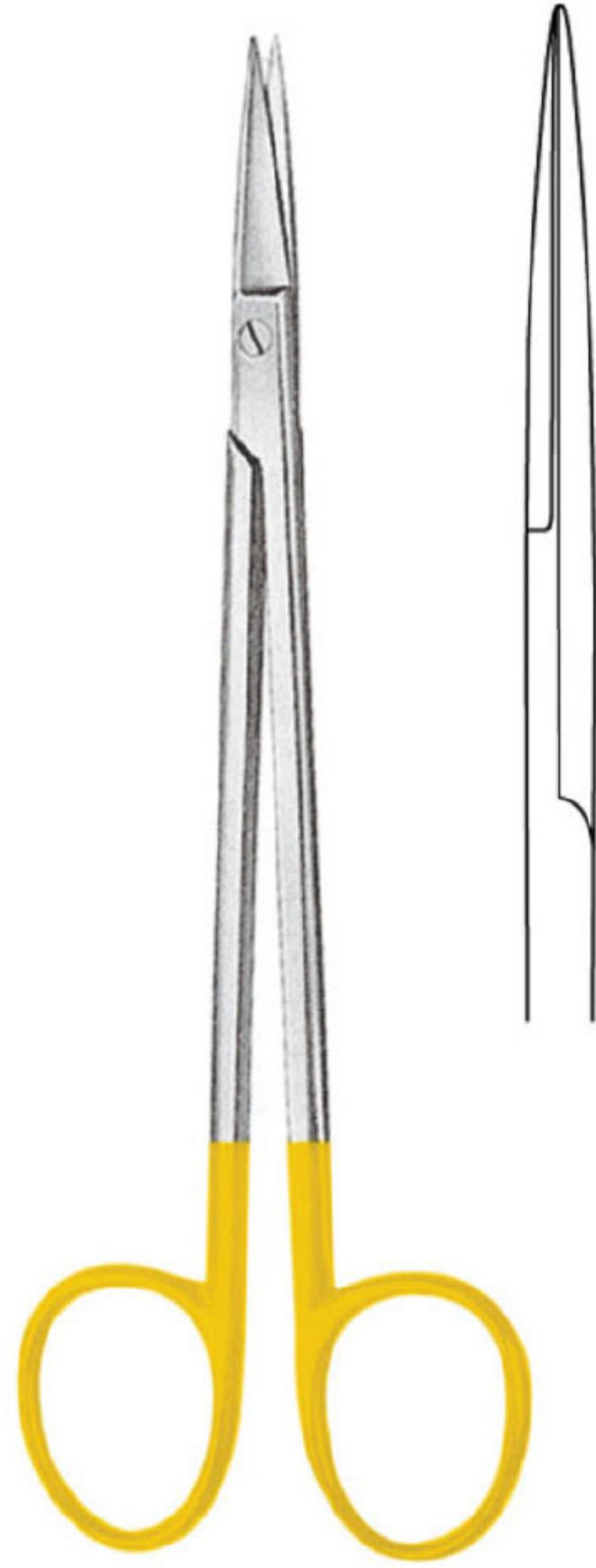

KELLY
 OI 06-1847-16 16 cm/6 1/4"
 OI 06-1847-18 18 cm/7 1/8"

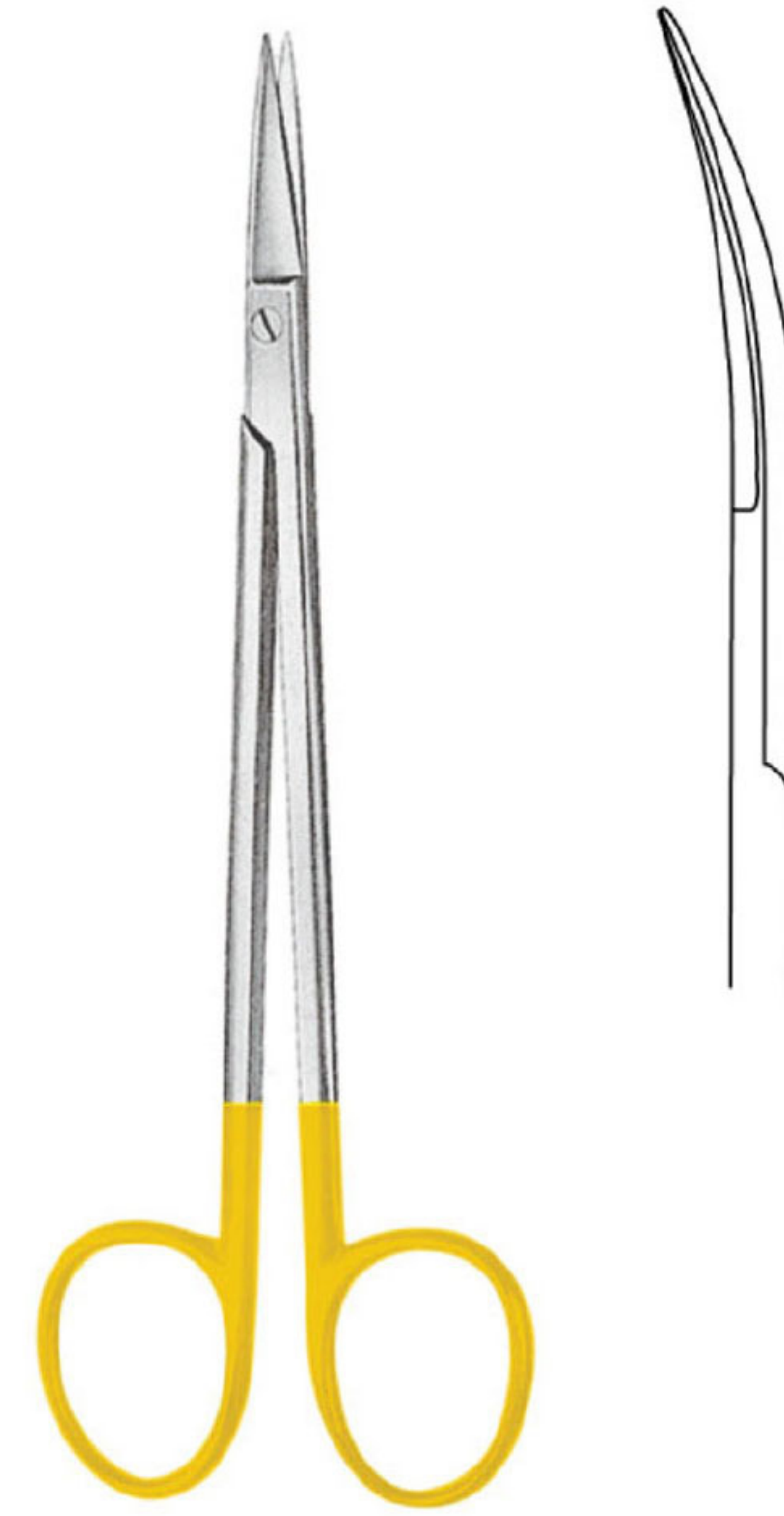

KELLY
 OI 06-1848-16 16 cm/6 1/4"
 OI 06-1848-18 18 cm/7 1/8"



RAGNELL
 OI 06-1849-12
 12 cm/4 3/4"



RAGNELL
 OI 06-1850-12
 12 cm/4 3/4"



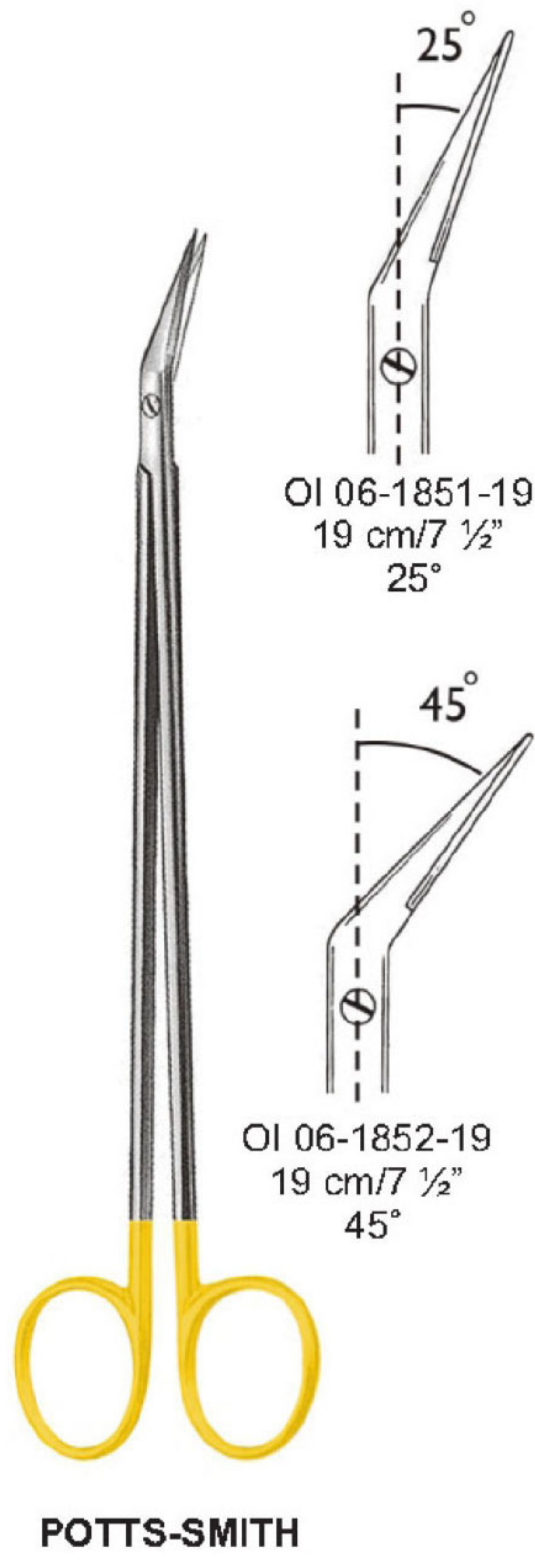

OI 06-1851-19
19 cm/7 1/2"
25°

OI 06-1852-19
19 cm/7 1/2"
45°

OI 06-1853-18
18.5 cm/7 1/4"
60°



OI 06-1855-19
19 cm/7 1/2"
25°

OI 06-1855-23
23 cm/9"
25°

OI 06-1855-28
28 cm/11"
25°

OI 06-1856-19
19 cm/7 1/2"
45°

OI 06-1856-23
23 cm/9"
45°

OI 06-1856-28
28 cm/11"
45°

OI 06-1857-19
19 cm/7 1/2"
60°

OI 06-1857-23
23 cm/9"
60°

OI 06-1857-28
28 cm/11"
60°

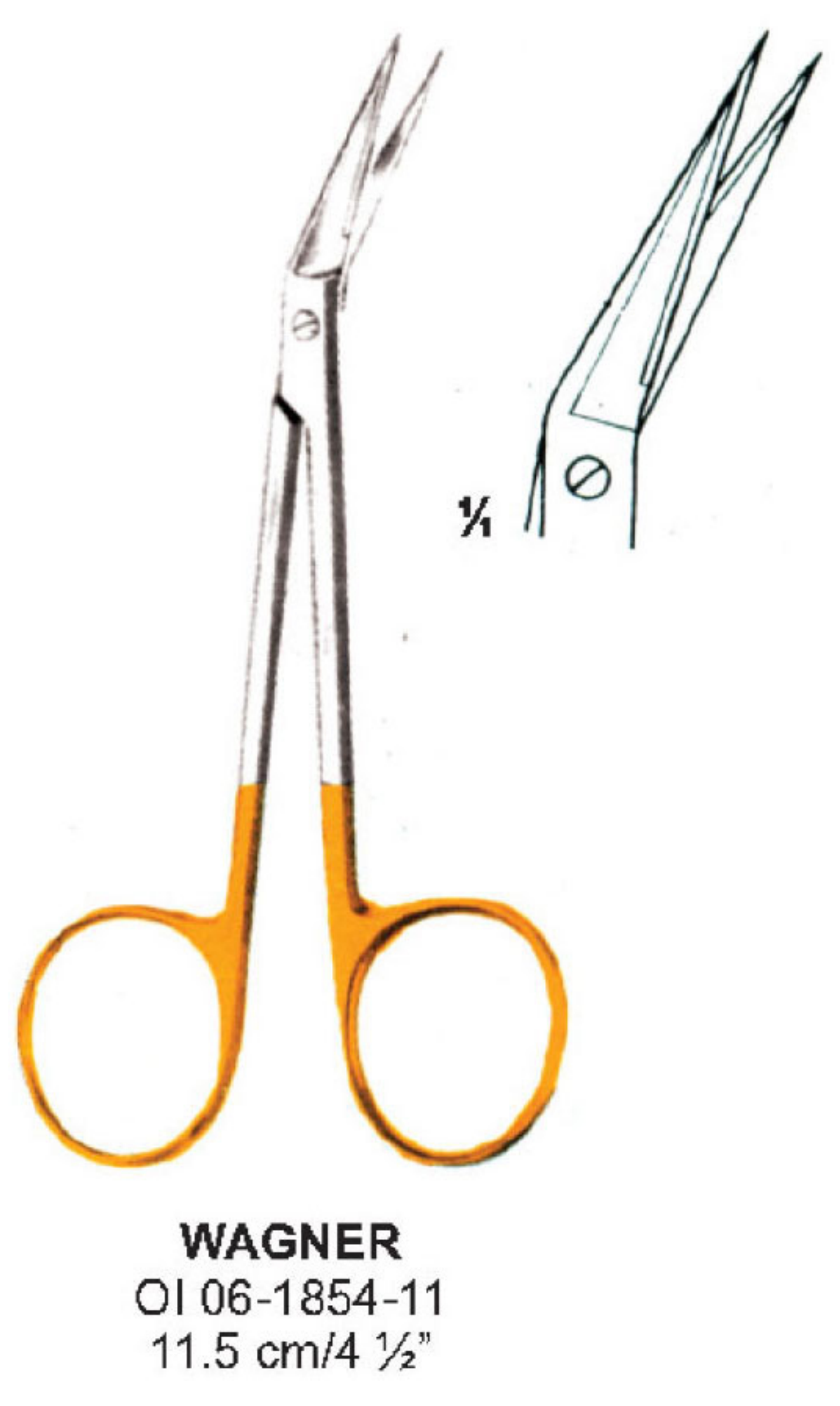

OI 06-1854-11
11.5 cm/4 1/2"

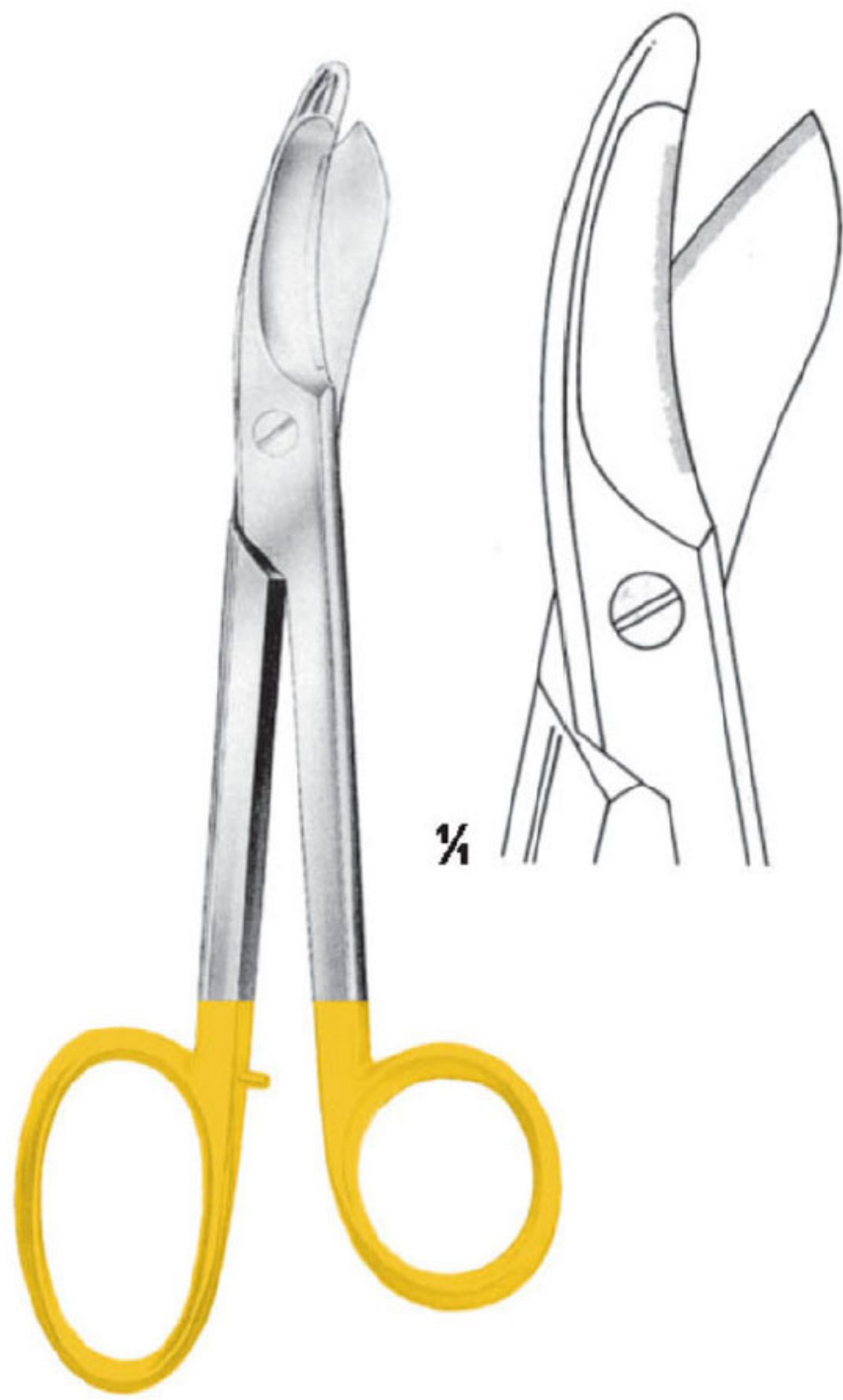

BRUNS-Plaster
 OI 06-1858-24
 24 cm/9 1/2"

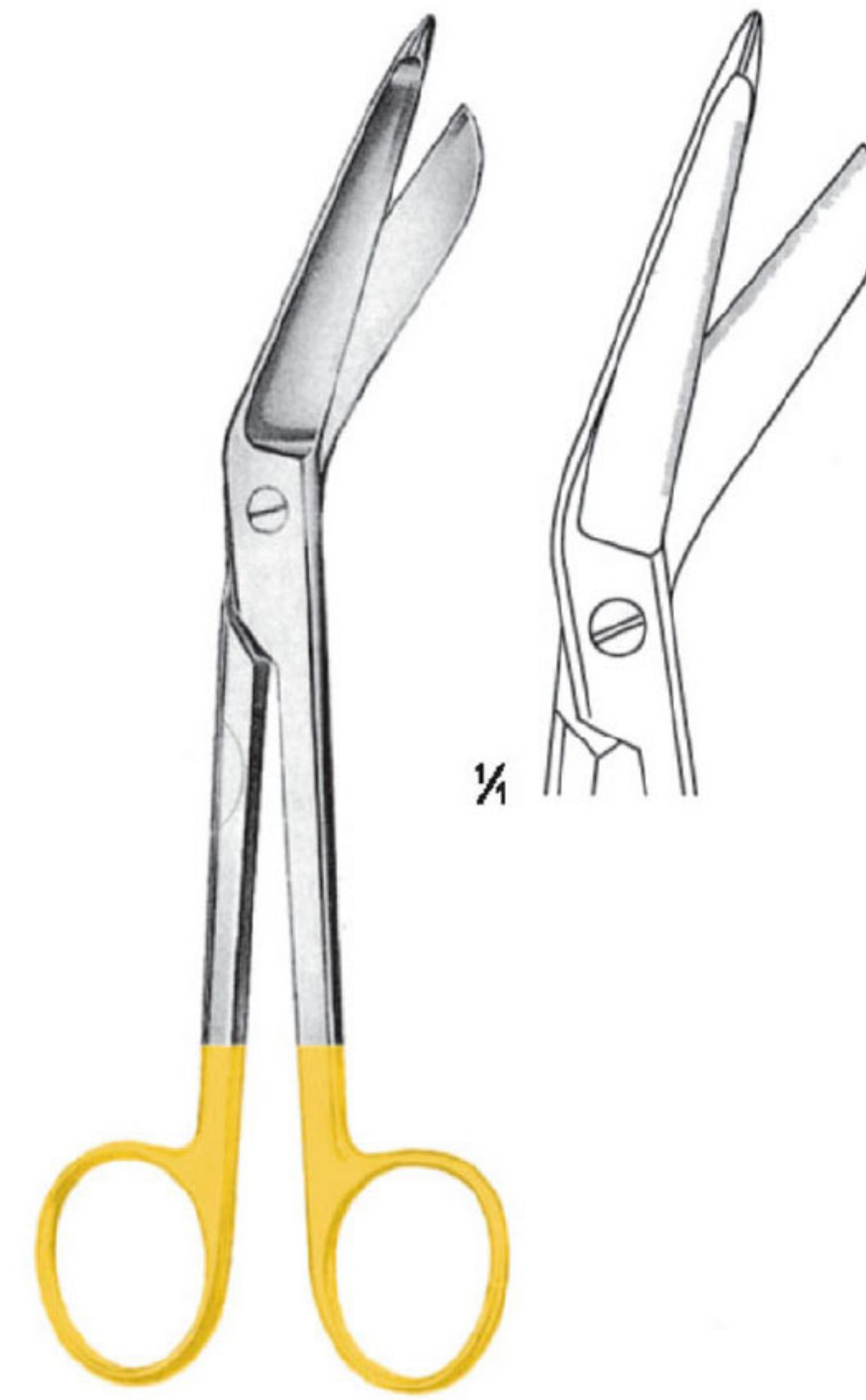

LISTER-Bandage
 OI 06-1859-18
 18 cm/7 1/8"

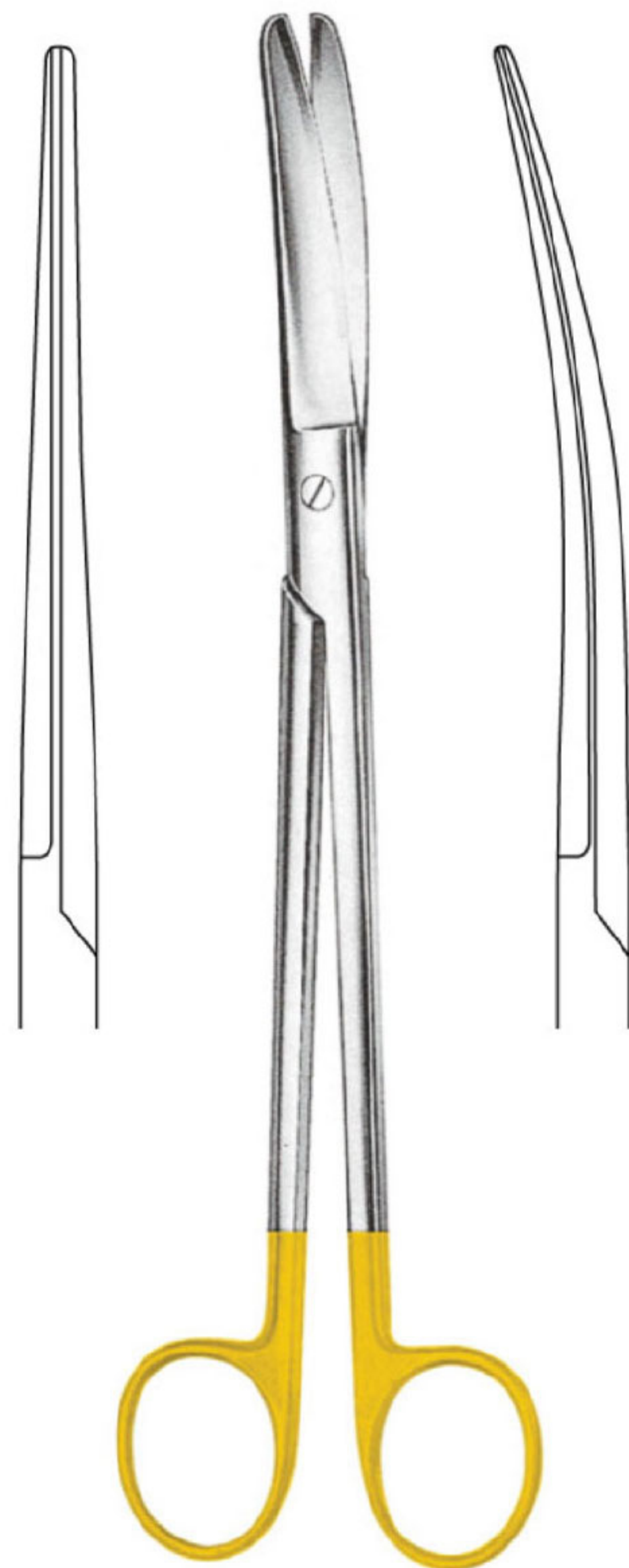

SIMS (Uterine)
 OI 06-1860-20 20 cm/7 7/8" OI 06-1861-20
 OI 06-1860-23 23 cm/9" OI 06-1861-23



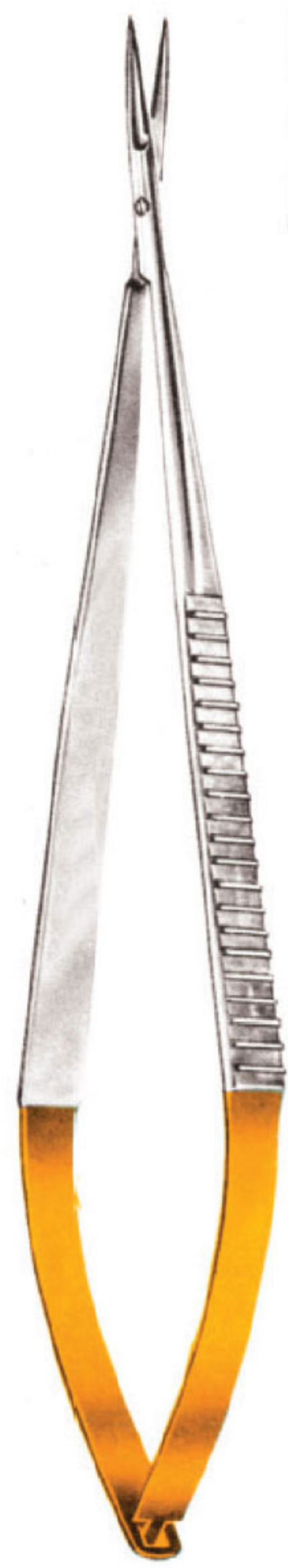

OI 06-1862-16
16 cm/6 1/4"

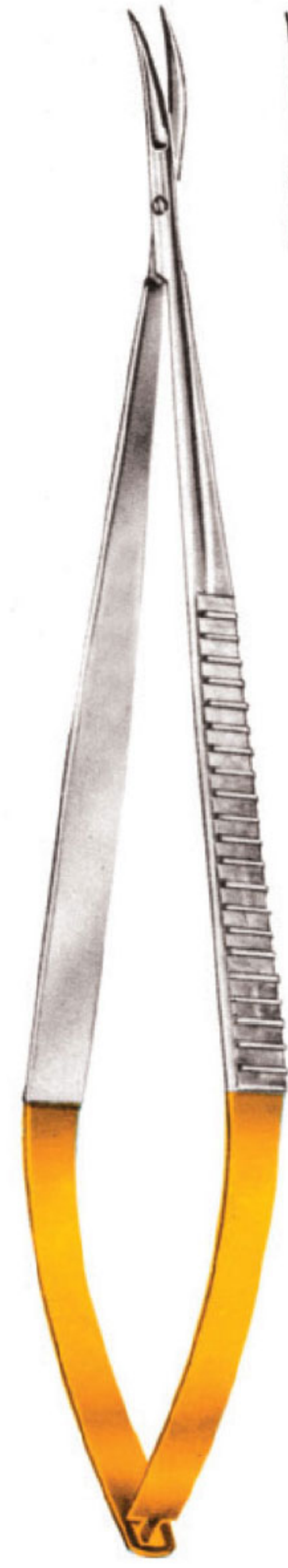

OI 06-1863-16
16 cm/6 1/4"



TC SCISSORS

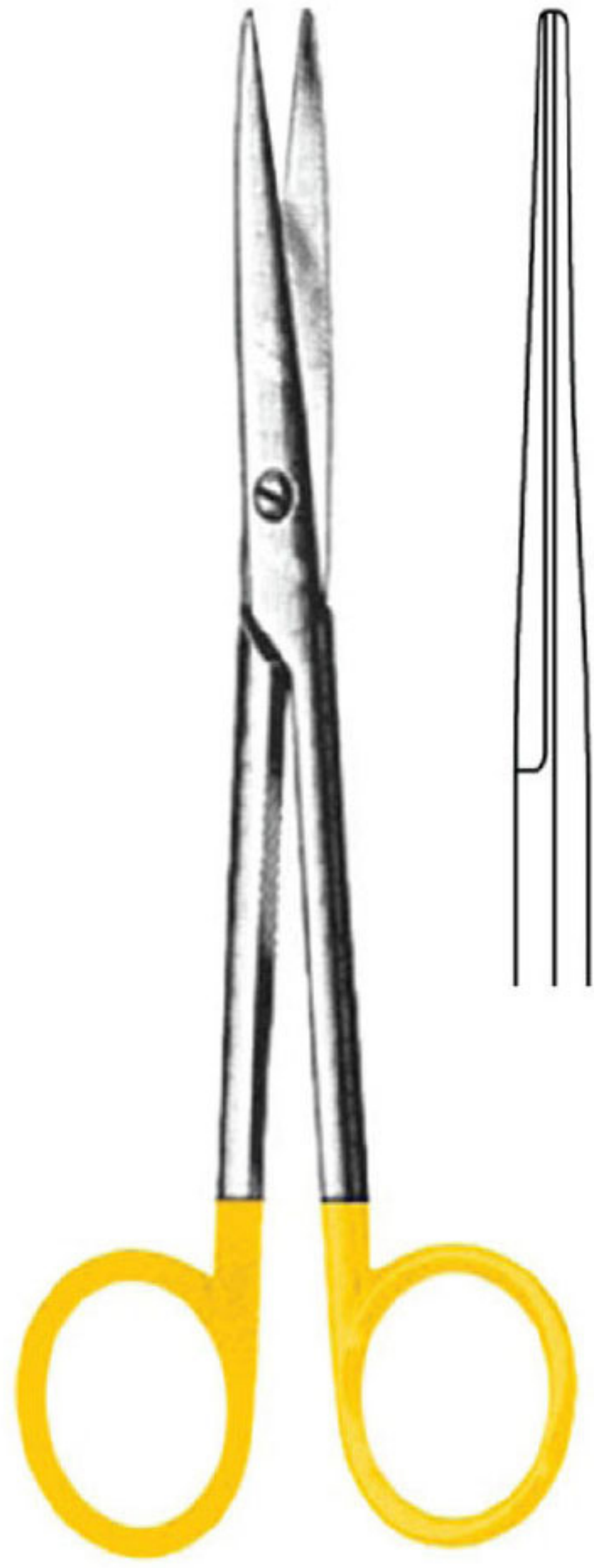

LEXER
OI 06-1864-16 16 cm/6 1/4"
OI 06-1864-21 21 cm/8 1/4"

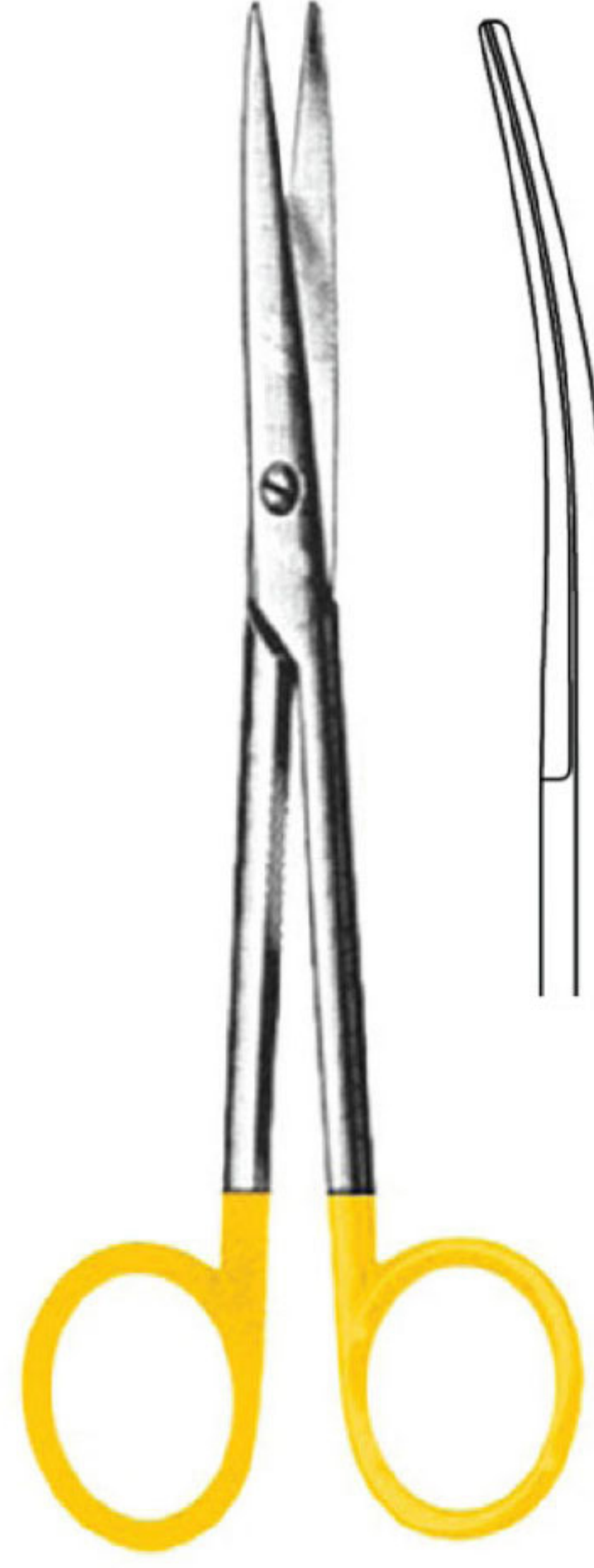

LEXER
OI 06-1865-16 16 cm/6 1/4"
OI 06-1865-21 21 cm/8 1/4"



PARAMETRIUM
OI 06-1866-22 22.5 cm/8 3/4"
OI 06-1866-23 23 cm/9"

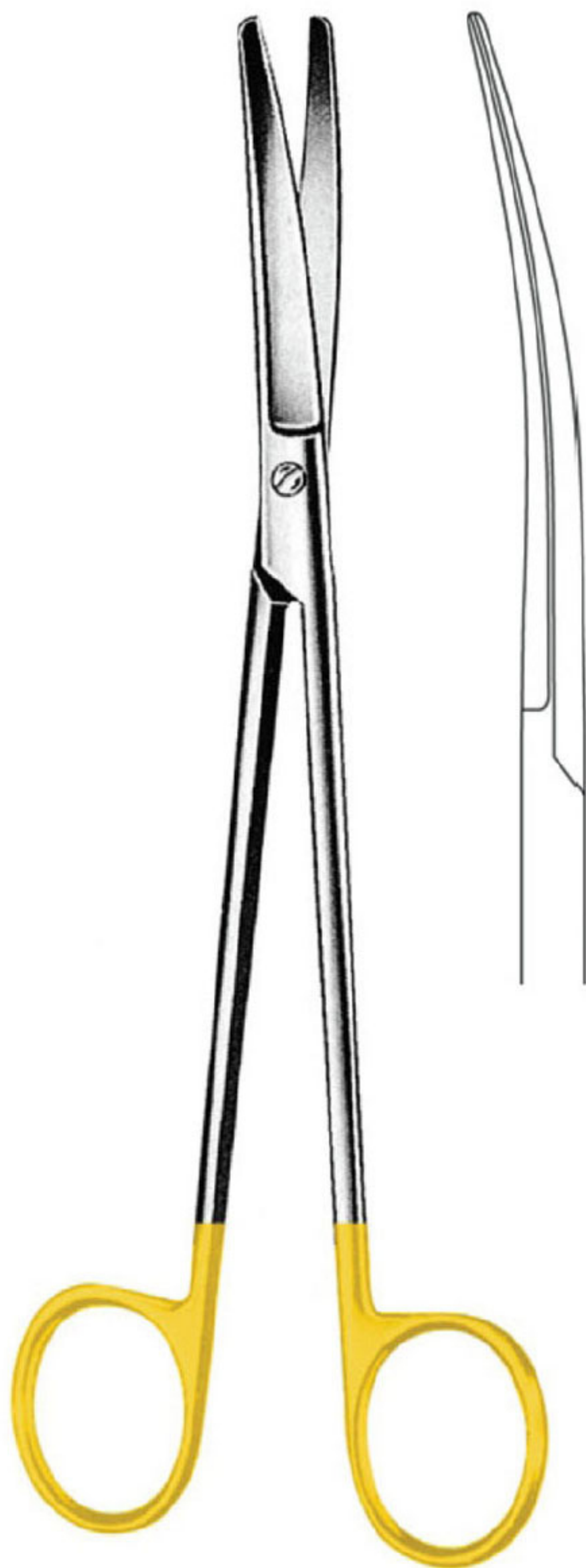

WERTHEIM
OI 06-1867-22
22.5 cm/8 3/4"

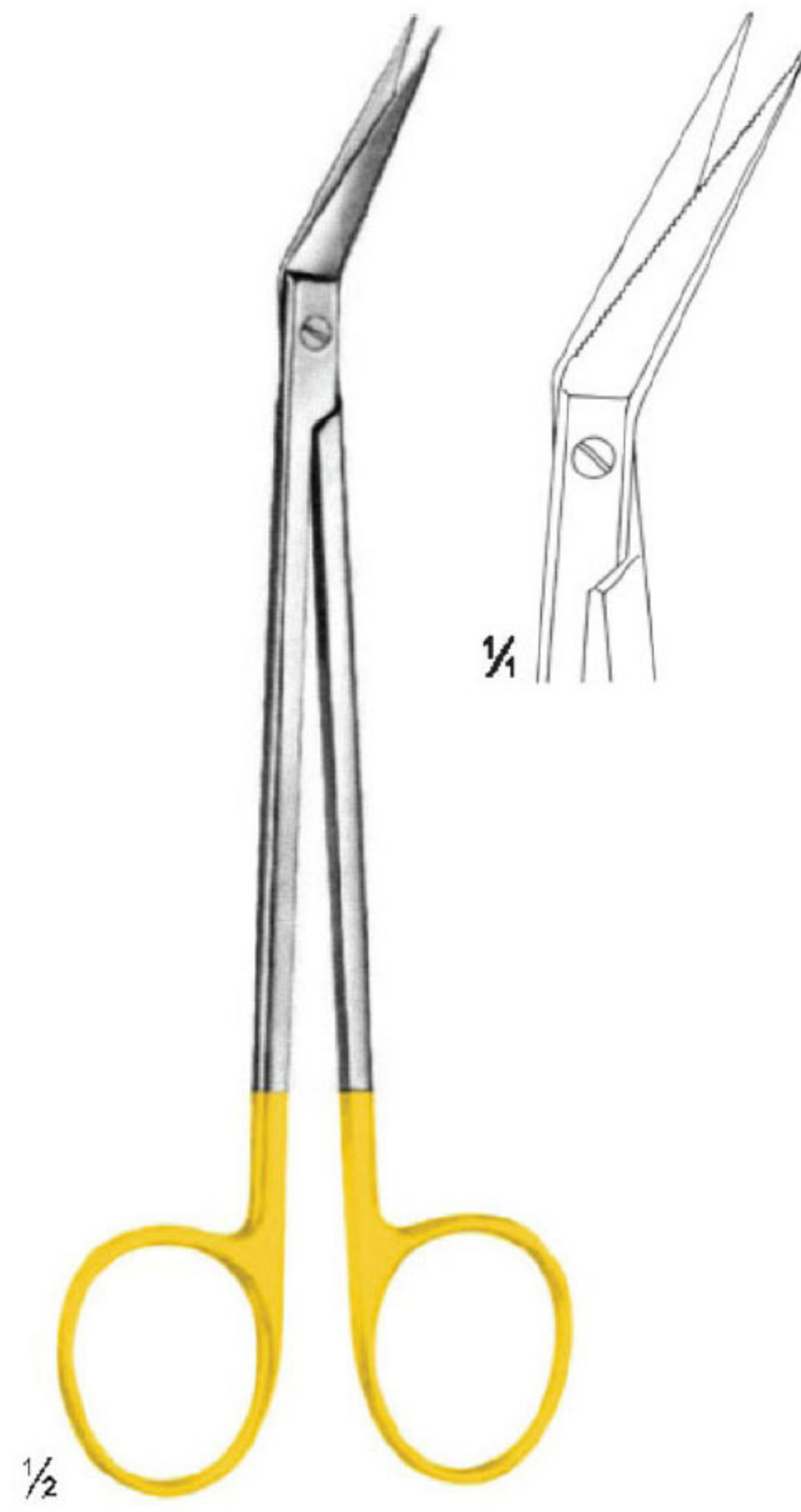

LOCKLIN
OI 06-1868-16
16 cm/6 1/4"
1 toothed blade



LOCKLIN
OI 06-1869-16
16 cm/6 1/4"
1 toothed blade

